











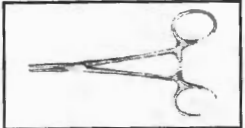

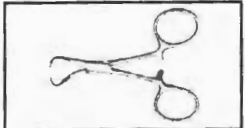

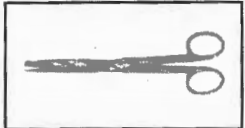
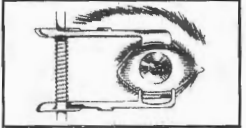
**SOLATCH SONS**

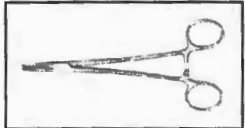

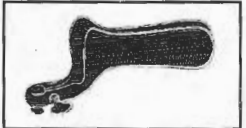
# Table of Contents

<p><b>01S</b></p>	 <p>PAGE 1 TO 3</p>	<p><b>DIAGNOSTIC INSTRUMENTS</b></p>	<p><b>10S</b></p>	 <p>PAGE 52 TO 57</p>	<p><b>NEURO SURGERY INSTRUMENTS</b></p>
<p><b>02S</b></p>	 <p>PAGE 4 TO 11</p>	<p><b>HEMOSTATIC INSTRUMENTS</b></p>	<p><b>11S</b></p>	 <p>PAGE 58 TO 73</p>	<p><b>BONE SURGERY INSTRUMENTS</b></p>
<p><b>03S</b></p>	 <p>PAGE 12</p>	<p><b>TOWEL CLAMPS</b></p>	<p><b>12S</b></p>	 <p>PAGE 74 TO 84</p>	<p><b>GYNECOLOGICAL &amp; OBSTETRICAL INSTRUMENTS</b></p>
<p><b>04S</b></p>	 <p>PAGE 13 TO 17</p>	<p><b>SCISSORS</b></p>	<p><b>13S</b></p>	 <p>PAGE 85 TO 94</p>	<p><b>EYE INSTRUMENTS</b></p>
<p><b>05S</b></p>	 <p>PAGE 18 TO 22</p>	<p><b>DRESSING &amp; TISSUE FORCEPS</b></p>	<p><b>14S</b></p>	 <p>PAGE 95 TO 96</p>	<p><b>ATRAUMATIC INSTRUMENTS</b></p>
<p><b>06S</b></p>	 <p>PAGE 23 TO 25</p>	<p><b>NEEDLE HOLDER</b></p>	<p><b>15S</b></p>	 <p>PAGE 97 TO 107</p>	<p><b>TONGSTEN CARBIDE INSTRUMENTS (T.C)</b></p>
<p><b>07S</b></p>	 <p>PAGE 26 TO 34</p>	<p><b>RETRACTORS</b></p>	<p><b>16S</b></p>	 <p>PAGE 108 TO 111</p>	<p><b>LASER SURGERY INSTRUMENTS</b></p>
<p><b>08S</b></p>	 <p>PAGE 35 TO 37</p>	<p><b>ORAL INSTRUMENTS</b></p>	<p><b>17S</b></p>	 <p>PAGE 112 TO 114</p>	<p><b>HOLLOWARE</b></p>
<p><b>09S</b></p>	 <p>PAGE 38 TO 51</p>	<p><b>E.N.T INSTRUMENTS</b></p>	<p><b>01D</b></p>	 <p>PAGE 115 TO 117</p>	<p><b>EXTRACTING FORCEPS</b></p>

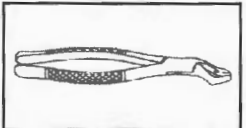

# DIAGNOSTIC INSTRUMENTS

SOLATCH SONS

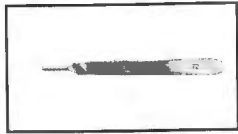

01S

Box of 100 Pcs

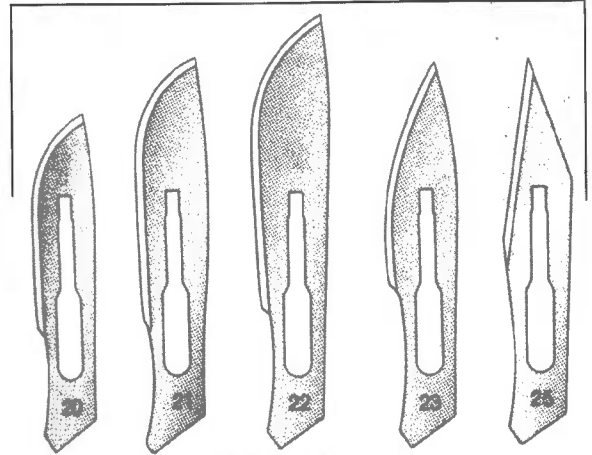

(Fits handles # 4, 4L,)

-01S-007    -01S-008    -01S-009    -01S-010    -01S-011

Carbon Steel Sterile Surgical Blades

Box of 100 Pcs

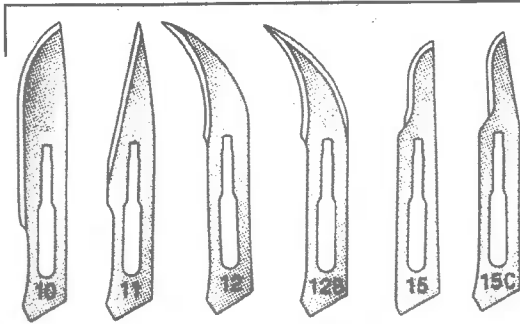

(Fits handles # 3, 3L, 3LA, 7, 9,)

-01S-001    -01S-002    -01S-003    -01S-004    -01S-005    -01S-006

Carbon Steel Sterile Surgical Blades

## Scalpel Handles

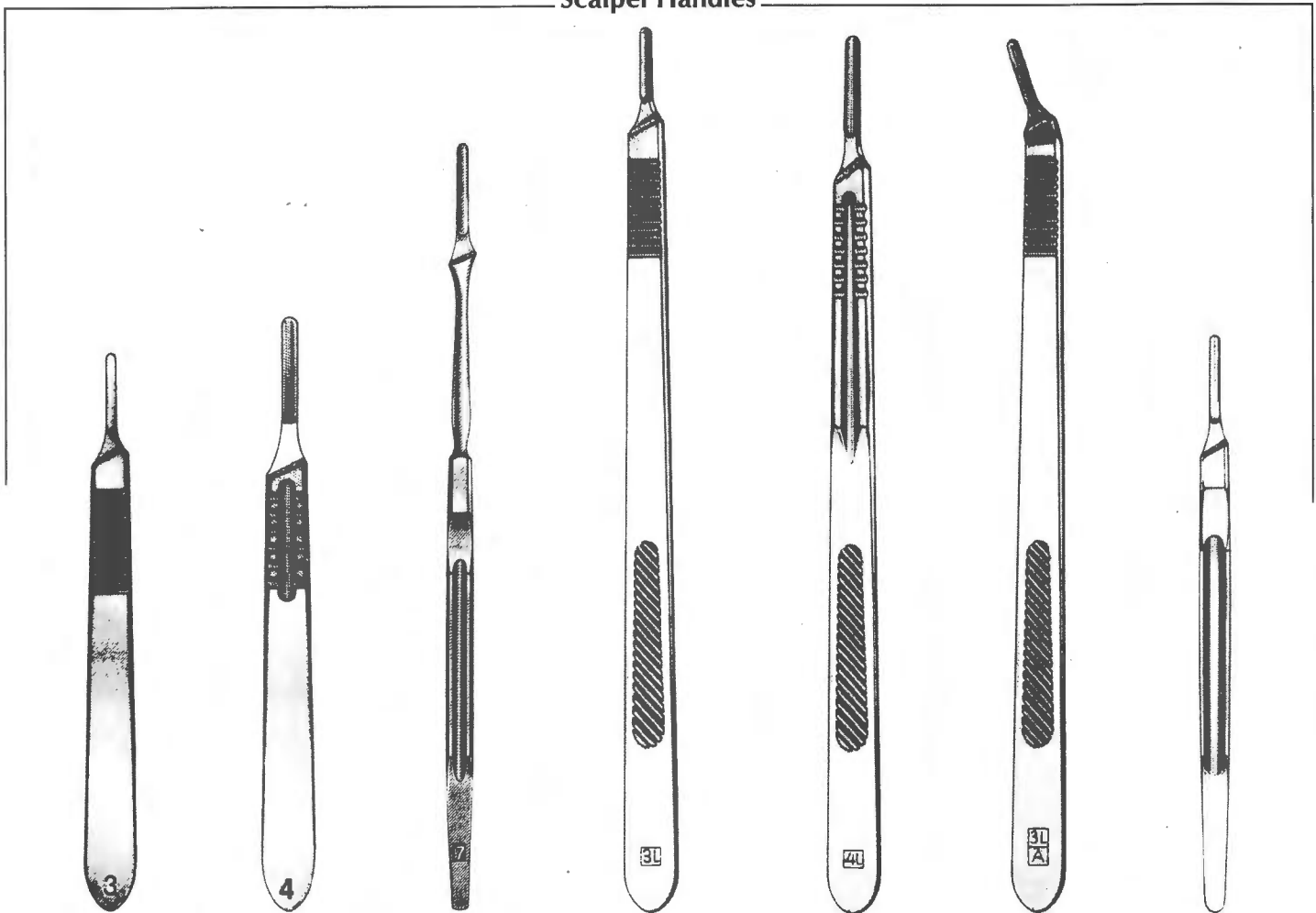

#3

-01S-012

#4

-01S-013

#7

-01S-014

#3L

-01S-015

#4L

-01S-016

#3LA

-01S-017

#9

-01S-018

**DIAGNOSTIC INSTRUMENTS**

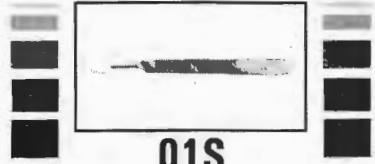

**01S**

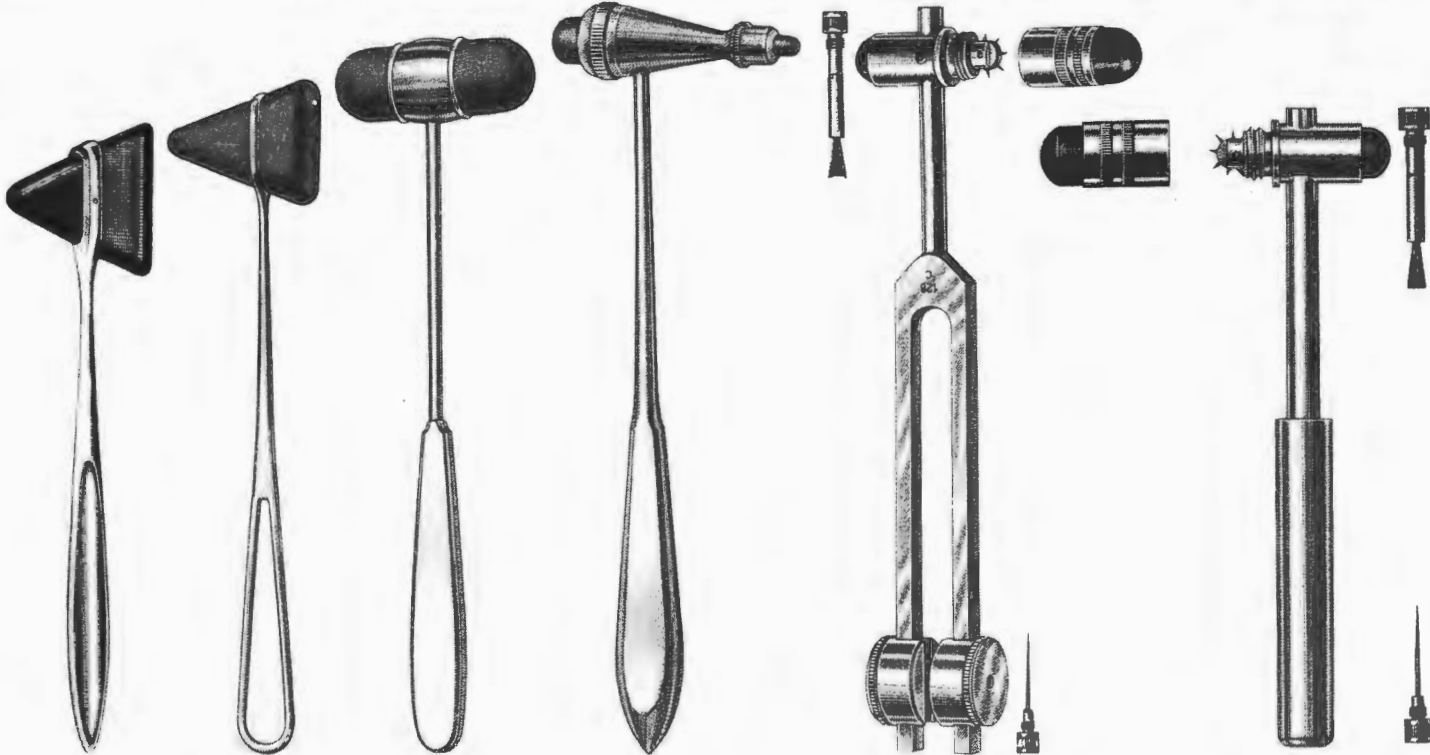

**-01S-019** Taylor Percussion Hammer 7 1/2" (19 cm)  
**-01S-020** Taylor Percussion Hammer 9" (22 cm)  
**-01S-021** Dejerine Percussion Hammer 9 1/2" (24 cm)  
**-01S-022** Tromner Percussion Hammer 9 3/4" (24,5 cm)  
**-01S-023** Combo-5 Neuro Diagnostic Set C-128 Tuning Fork, Buck Hammer, Pin Wheel, Brush & Needle  
**-01S-024** Combo-4 Neuro Diagnostic Set Buck Hammer, Pin Wheel, Brush & Needle

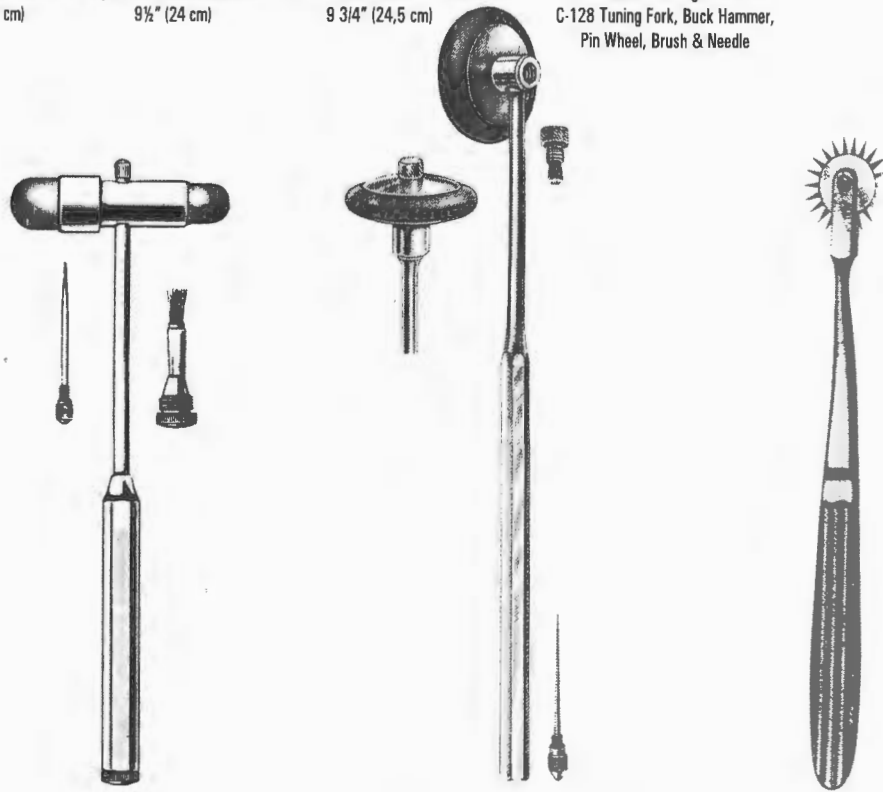

**-01S-025** Buck Neurological Hammer with Brush and Needle (screw into handle) chrome 7 3/4" (19,7 cm)  
**-01S-026** Rabiner Neurological Hammer with Brush and Needle (screw into handle) chrome 9" (22,9 cm)  
**-01S-027** Wartenberg Neurological Pin Wheel 7" (17,8 cm)



01S

# DIAGNOSTIC INSTRUMENTS

SOLATCH SONS



Probes, Double End

ARTICLE #	SIZE
-01S-028	4 1/2" (11,4 cm)
-01S-029	5" (12,7 cm)
-01S-030	5 1/2" (14 cm)
-01S-031	6" (15,2 cm)
-01S-032	7" (17,8 cm)
-01S-033	8" (20,3 cm)
-01S-034	10" (25,4 cm)



Probes, With Eye

ARTICLE #	SIZE
-01S-035	4 1/2" (11,4 cm)
-01S-036	5" (12,7 cm)
-01S-037	5 1/2" (14 cm)
-01S-038	6" (15,2 cm)
-01S-039	7" (17,8 cm)
-01S-040	8" (20,3 cm)
-01S-041	10" (25,4 cm)



-01S-042  
Probe with Myrtle Leaf  
5" (12,7 cm)



Grooved Directors With Tongue Tie

ARTICLE #	SIZE
-01S-043	4 1/2" (11,4 cm)
-01S-044	5" (12,7 cm)
-01S-045	5 1/2" (14 cm)
-01S-046	6" (15,2 cm)
-01S-047	8" (20,3 cm)



Grooved Directors With Probe Tip  
& Tongue Tie

ARTICLE #	SIZE
-01S-048	4 1/2" (11,4 cm)
-01S-049	5" (12,7 cm)
-01S-050	5 1/2" (14 cm)
-01S-051	6" (15,2 cm)
-01S-052	8" (20,3 cm)



-01S-053  
Larry Probe and Grooved Director  
7" (17,8 cm)

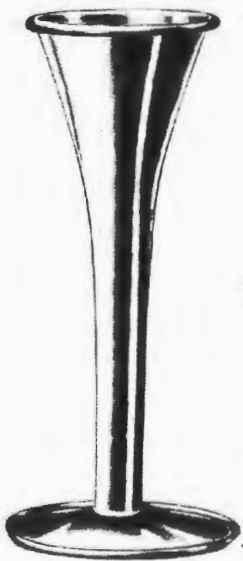

-01S-054  
Pinard Fetal Head Stethoscope (Aluminum)

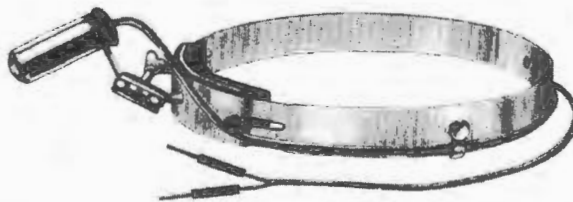

-01S-055  
Head Light



-01S-056  
Mirror Head

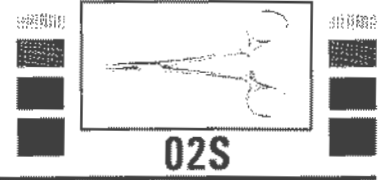

<p><b>-02S-001</b> 3 1/2" (9 cm)</p> <p><b>-02S-002</b> 3 1/2" (9 cm)</p> <p><b>Baby-Mosquito Forceps (HARTMANN)</b></p>	<p><b>-02S-003</b> 3 1/2" (10 cm)</p> <p><b>-02S-004</b> 3 1/2" (10 cm)</p> <p><b>-02S-005</b> 3 1/2" (10 cm)</p> <p><b>-02S-006</b> 3 1/2" (10 cm)</p> <p><b>1 x 2 Teeth</b></p> <p><b>Micro-Mosquito Forceps</b></p>	<p><b>-02S-007</b> 5" (12 cm)</p> <p><b>-02S-008</b> 5" (12 cm)</p> <p><b>-02S-009</b> 5" (12 cm)</p> <p><b>-02S-010</b> 5" (12 cm)</p> <p><b>1 x 2 Teeth</b></p> <p><b>Micro-Halstead-Mosquito Forceps</b></p>
<p><b>-02S-011</b> 5" (12 cm)</p> <p><b>-02S-012</b> 5" (12 cm)</p> <p><b>-028013</b> 5" (12 cm)</p> <p><b>-02S-014</b> 5" (12 cm)</p> <p><b>1 x 2 Teeth</b></p> <p><b>Halstead-Mosquito Forceps</b></p>	<p><b>-02S-015</b> 5 1/2" (14 cm)</p> <p><b>-02S-016</b> 5 1/2" (14 cm)</p> <p><b>-02S-017</b> 5 1/2" (14 cm)</p> <p><b>-02S-018</b> 5 1/2" (14 cm)</p> <p><b>1 x 2 Teeth</b></p> <p><b>Halstead-Mosquito Forceps</b></p>	<p><b>-02S-019</b> 7" (18 cm)</p> <p><b>-02S-020</b> 8" (20 cm)</p> <p><b>-02S-021</b> 7" (18 cm)</p> <p><b>-02S-022</b> 8" (20 cm)</p> <p><b>-02S-023</b> 7" (18 cm)</p> <p><b>-02S-024</b> 8" (20 cm)</p> <p><b>-02S-025</b> 7" (18 cm)</p> <p><b>-02S-026</b> 8" (20 cm)</p> <p><b>1 x 2 Teeth</b></p> <p><b>Halstead-Mosquito Forceps</b></p>

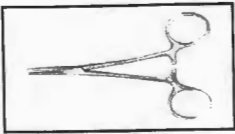

02S

# HEMOSTATIC INSTRUMENTS

SOLATCH SONS

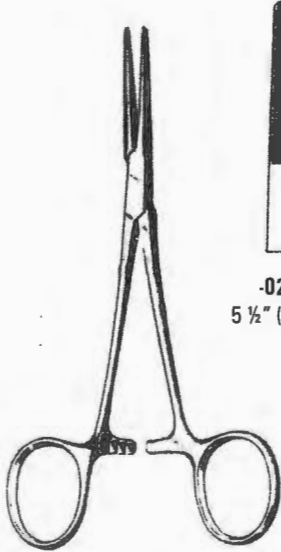

Kelly Hemostatic Forceps



-02S-027  
5 1/2" (14 cm)



-02S-028  
5 1/2" (14 cm)

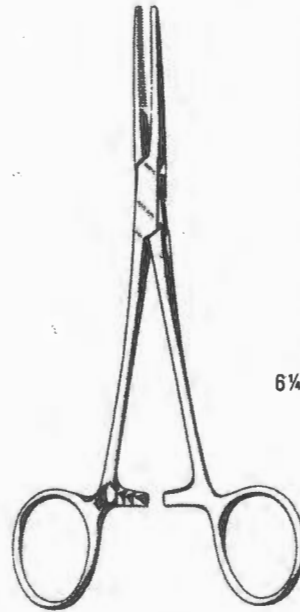

Kelly-Rankin Hemostatic Forceps



-02S-029  
6 1/4" (16 cm)



-02S-030  
6 1/4" (16 cm)

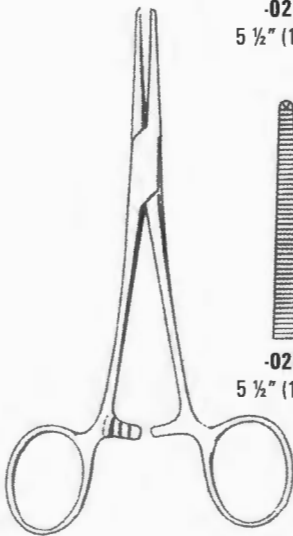

Crile-Hemostatic Forceps



-02S-031  
5 1/2" (14 cm)



-02S-032  
5 1/2" (14 cm)



-02S-033  
5 1/2" (14 cm)



-02S-034  
5 1/2" (14 cm)

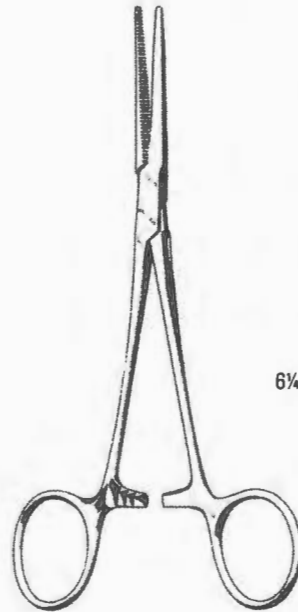

Crile-Rankin Hemostatic Forceps



-02S-035  
6 1/4" (16 cm)



-02S-036  
6 1/4" (16 cm)



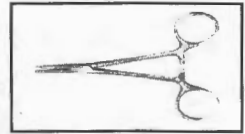

**02S**

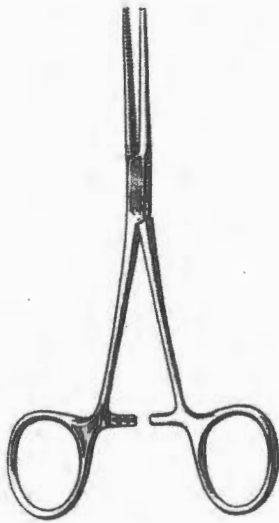

**Kocher Hemostatic Forceps 1 x 2 Teeth**

ARTICLE # Straight	Size	ARTICLE # Curved
-02S-037	5 1/2" (14 cm)	-02S-045
-02S-038	6 1/4" (16 cm)	-02S-046
-02S-039	7" (18 cm)	-02S-047
-02S-040	8" (20 cm)	-02S-048
-02S-041	8 1/4" (22 cm)	-02S-049
-02S-042	9 1/2" (24 cm)	-02S-050
-02S-043	10 1/4" (26 cm)	-02S-051
-02S-044	12" (30 cm)	-02S-052

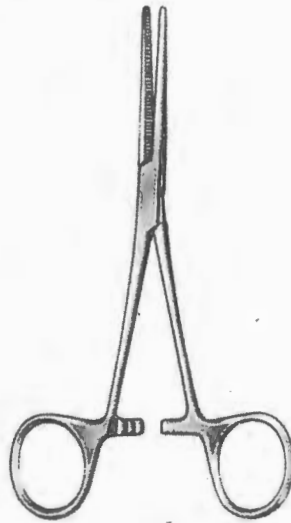

**Rochester Pean Forceps Serrated**

ARTICLE # Straight	Size	ARTICLE # Curved
-02S-053	5 1/2" (14 cm)	-02S-061
-02S-054	6 1/4" (16 cm)	-02S-062
-02S-055	7" (18 cm)	-02S-063
-02S-056	8" (20 cm)	-02S-064
-02S-057	8 1/4" (22 cm)	-02S-065
-02S-058	9 1/2" (24 cm)	-02S-066
-02S-059	10 1/4" (26 cm)	-02S-067
-02S-060	12" (30 cm)	-02S-068

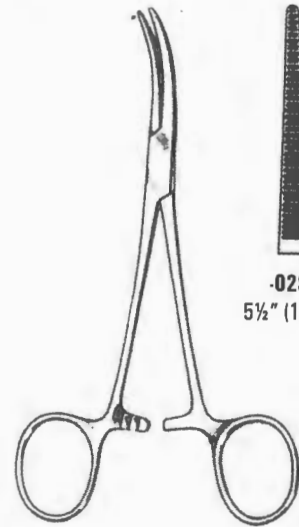

**Dandy Hemostatic Forceps**

**-02S-069**  
5 1/2" (14 cm)

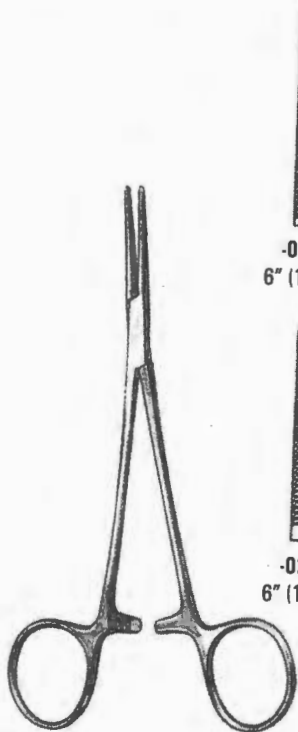

**Leriche Hemostatic Forceps**

**-02S-070**  
6" (15 cm)

**-02S-072**  
6" (15 cm)



**-02S-071**  
6" (15 cm)



**-02S-073**  
6" (15 cm)

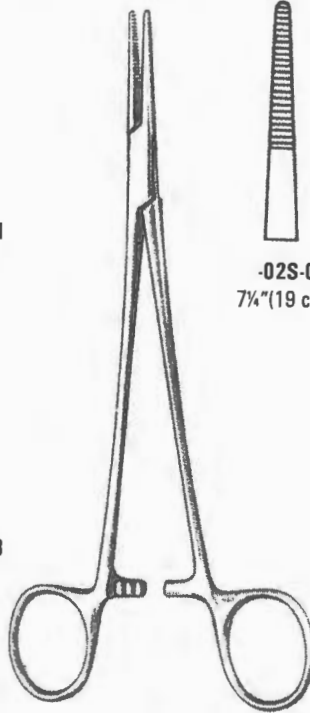

**Adson Hemostatic Forceps**

**-02S-074**  
7 1/4" (19 cm)



**-02S-075**  
7 1/4" (19 cm)

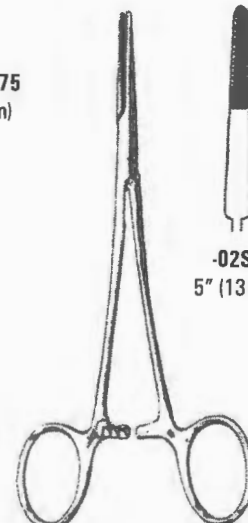

**Providence-Hospital Hemostatic Forceps**

**-02S-076**  
5" (13 cm)

**-02S-077**  
5" (13 cm)

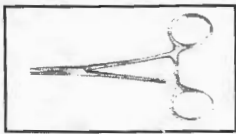

02S

# HEMOSTATIC INSTRUMENTS

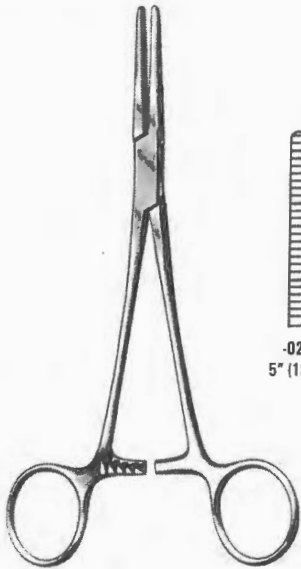

Spencer-Wells Artery Forceps

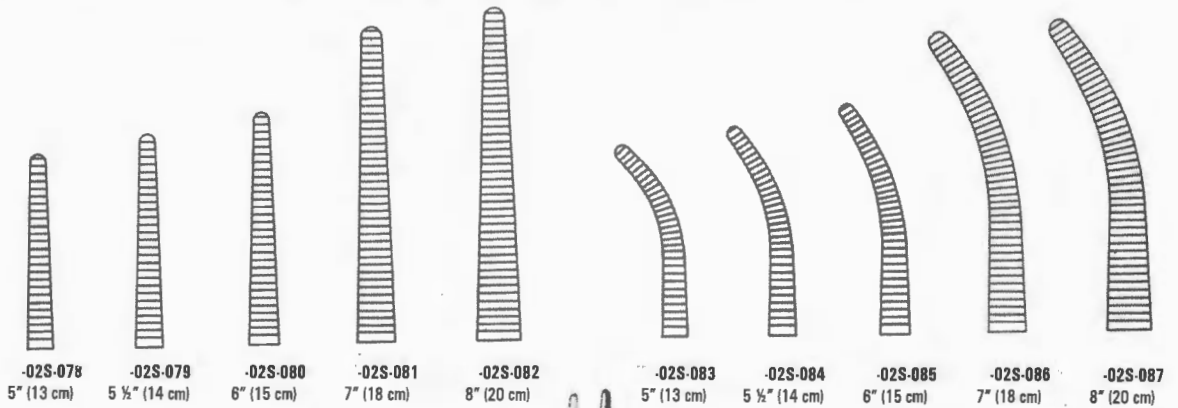

Rochester-Carmalt Forceps

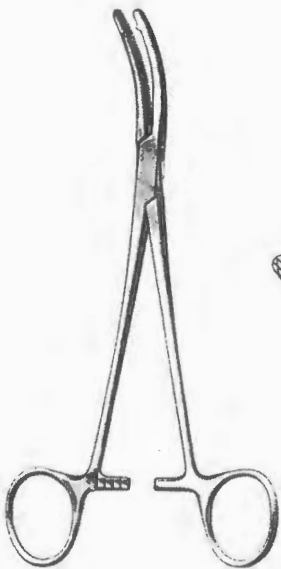
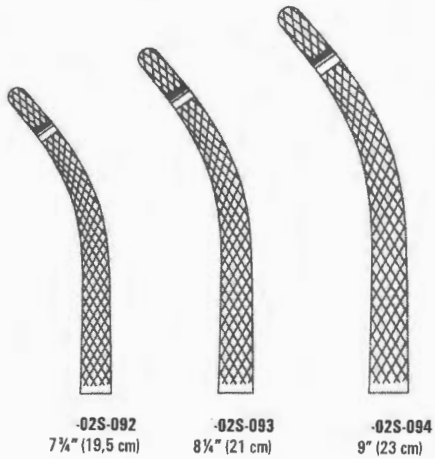
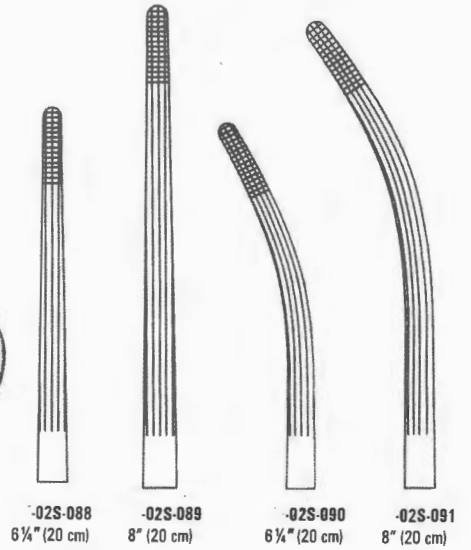

Heaney Hemostatic Forceps

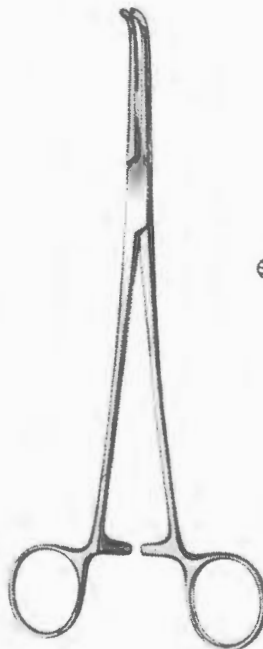
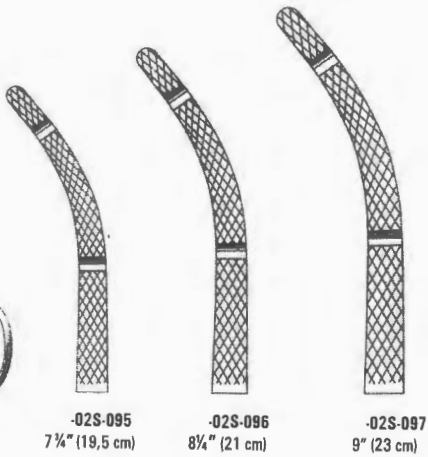

Mixer Artery Forceps



# HEMOSTATIC INSTRUMENTS

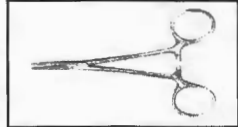

02S

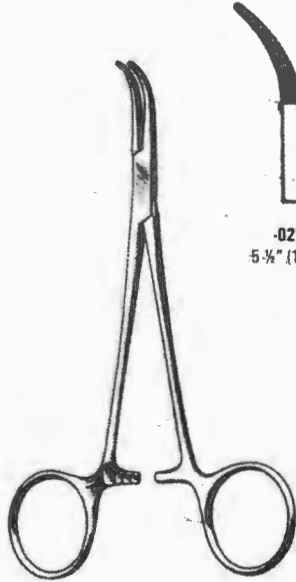

-02S-101  
5 1/4" (14 cm)



-02S-102  
5 1/4" (14 cm)

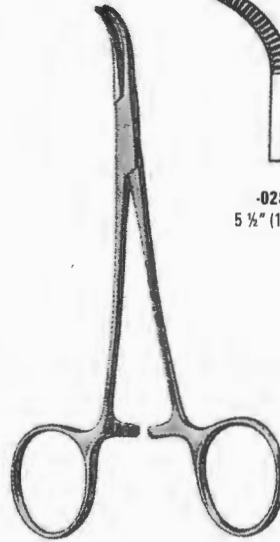

-02S-103  
5 1/4" (14 cm)

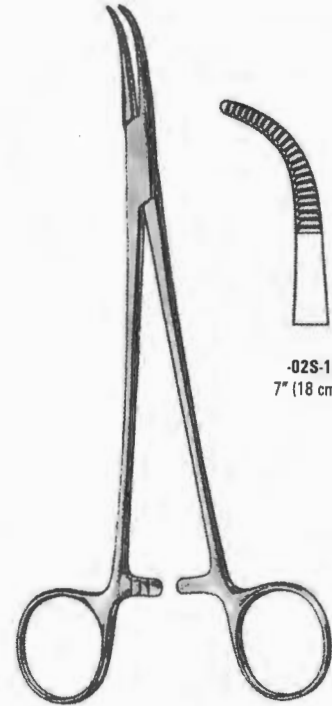

-02S-104  
7" (18 cm)

Baby-Mixer Forceps

Baby-Mixer Forceps

Baby-Mixer Forceps

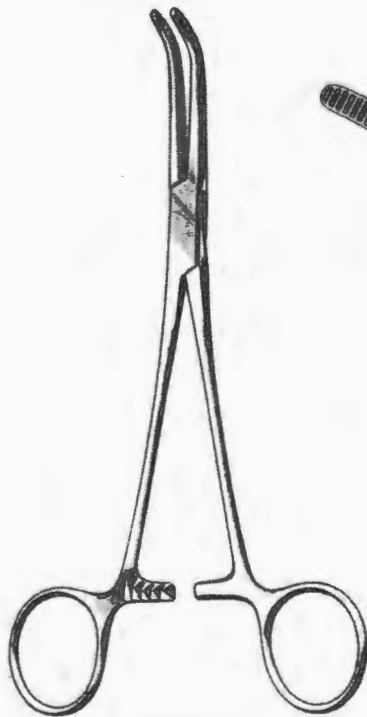

TRI-02S-105  
Mixer Oschner Artery Forceps  
7 1/2" (19 cm)

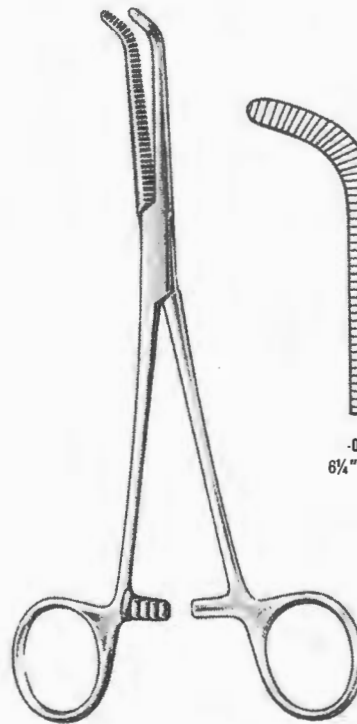

Mixer Artery Forceps



-02S-106  
6 1/4" (19 cm)

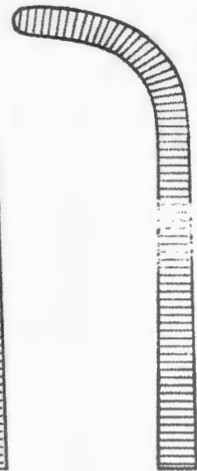

-02S-107  
7 1/2" (19,5 cm)

-02S-108  
8 1/2" (21,5 cm)

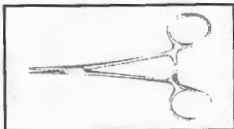

02S

# HEMOSTATIC INSTRUMENTS

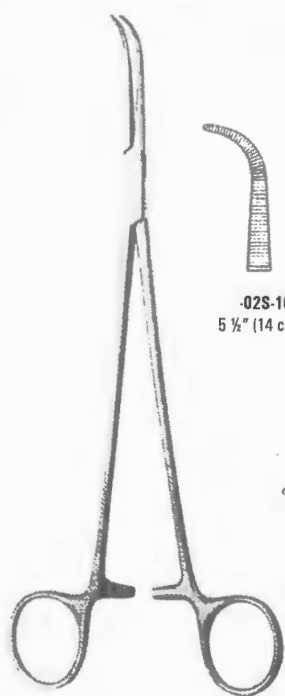

Gemini Hemostatic Forceps



-02S-109 5 1/2" (14 cm)  
 -02S-110 6 3/4" (16 cm)  
 -02S-111 7" (18 cm)  
 -02S-112 8" (20 cm)

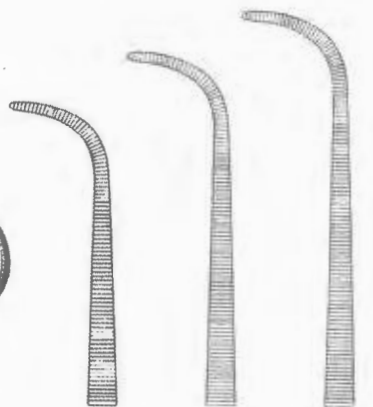

-02S-113 9" (23 cm)  
 -02S-114 10" (25 cm)  
 -02S-114 11" (28 cm)

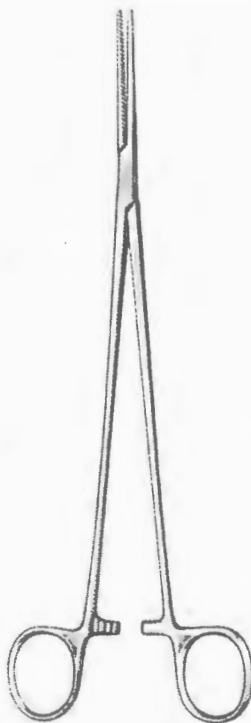

Bangolea Hemostatic Forceps

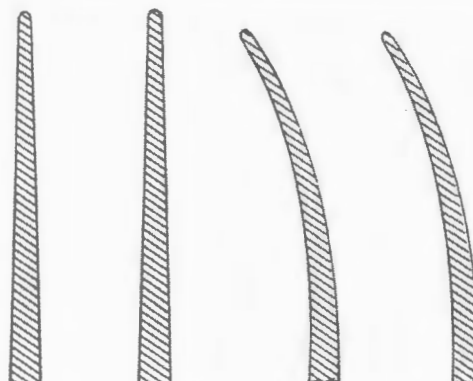

-02S-116 9 1/2" (24 cm)  
 -02S-117 10 1/4" (26 cm)  
 -02S-118 9 1/2" (24 cm)  
 -02S-119 10 1/4" (26 cm)

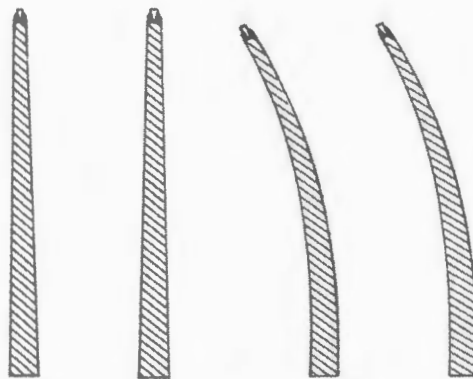

-02S-120 9 1/2" (24 cm)  
 -02S-121 10 1/4" (26 cm)  
 -02S-122 9 1/2" (24 cm)  
 -02S-123 10 1/4" (26 cm)

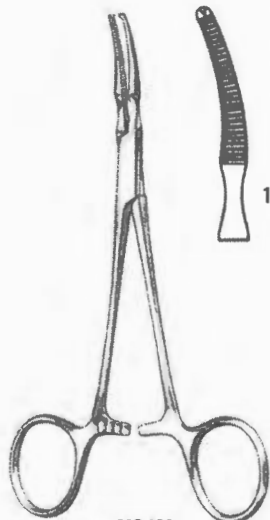

-02S-124  
 Baby-Mikulicz Peritoneal  
 Clamp Forceps  
 5 1/2" (14 cm)



1 x 2 Teeth

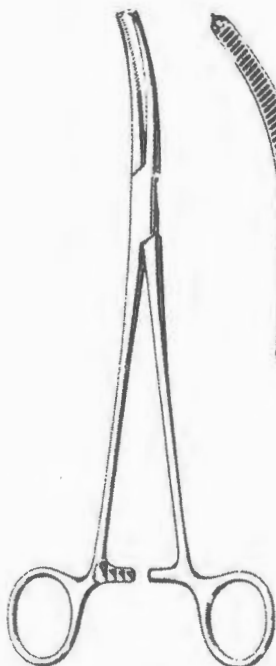

-02S-125  
 Mikulicz Peritoneal  
 Clamp Forceps  
 8" (20,5 cm)



1 x 2 Teeth

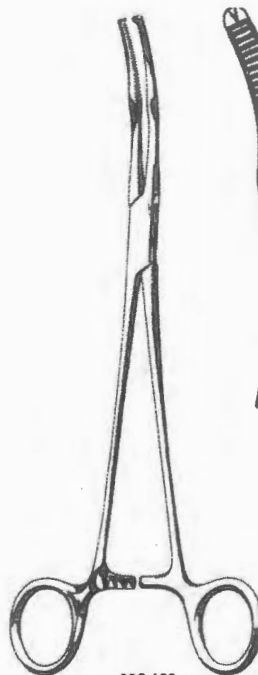

-02S-126  
 Mikulicz Peritoneal  
 Clamp Forceps  
 8 1/2" (21,5 cm)



1 x 2 Teeth

# HEMOSTATIC INSTRUMENTS



SIZE	2x3 Teeth	3x4 Teeth	4x5 Teeth	4x5 Teeth	5x6 Teeth	6x7 Teeth
	Allis	Judd-Allis	Baby-Allis	Allis	Allis	Thomas-Allis
5" (13 cm)	-02S-127	-02S-132	-02S-137	-02S-142	-02S-147	-02S-152
6" (15 cm)	-02S-128	-02S-133	-02S-138	-02S-143	-02S-148	-02S-153
7 1/2" (19 cm)	-02S-129	-02S-134	-02S-139	-02S-144	-02S-149	-02S-154
8" (20 cm)	-02S-130	-02S-135	-02S-140	-02S-145	-02S-150	-02S-155
10" (25 cm)	-02S-131	-02S-136	-02S-141	-02S-146	-02S-151	-02S-156

ARTICLE #	SIZE
-02S-157	5.5" (14,5 cm)
-02S-158	6.5" (16 cm)
-02S-159	7" (18 cm)
-02S-160	8.5" (21 cm)
-02S-161	9.5" (24 cm)

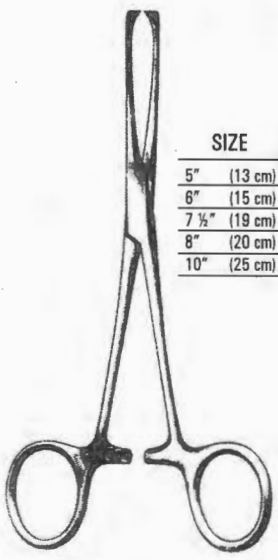

Allis Forceps

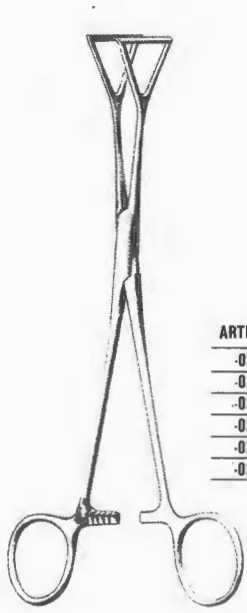

Babcock Forceps

ARTICLE #	A (mm)	SIZE
-02S-164	14 mm	8" (20 cm)
-02S-165	18 mm	8" (20 cm)
-02S-166	28 mm	8" (20 cm)
-02S-167	14 mm	9" (23 cm)
-02S-168	18 mm	9" (23 cm)
-02S-169	28 mm	9" (23 cm)



Duval Forceps

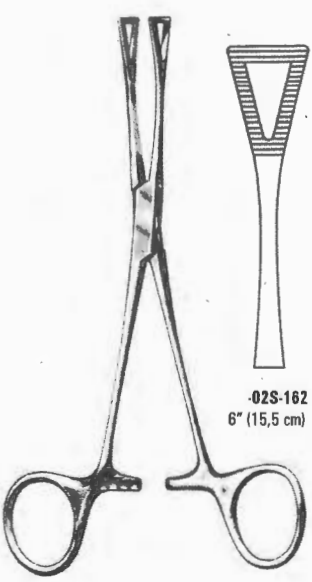

Pennington Forceps

-02S-162  
6" (15,5 cm)

-02S-162  
8" (20 cm)

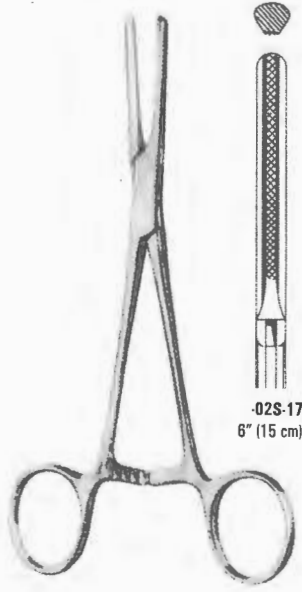

Tube Occluding Forceps

-02S-170  
6" (15 cm)

-02S-171  
7" (18 cm)

-02S-172  
8" (20 cm)

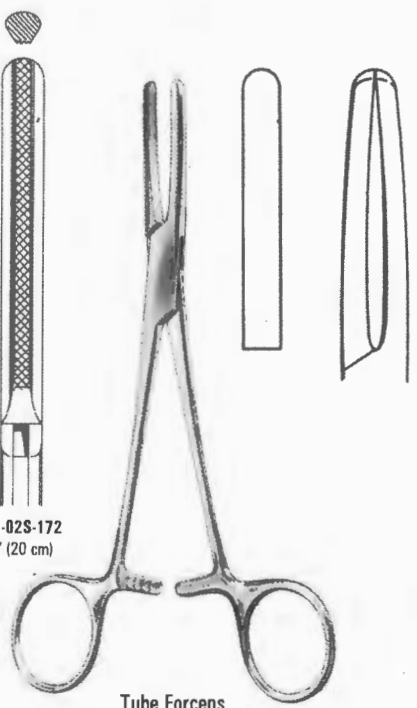

Tube Forceps

ARTICLE #	SIZE
-02S-173	5 1/2" (14 cm)
-02S-174	6 1/2" (16,5 cm)
-02S-175	7 1/4" (18 cm)

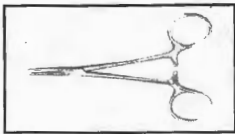

**02S**

# HEMOSTATIC INSTRUMENTS

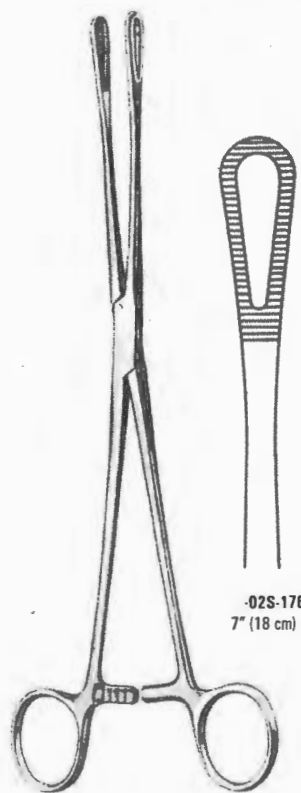

**-02S-176**  
7" (18 cm)

Rampley Spong Forceps



**-02S-177**  
10" (25 cm)

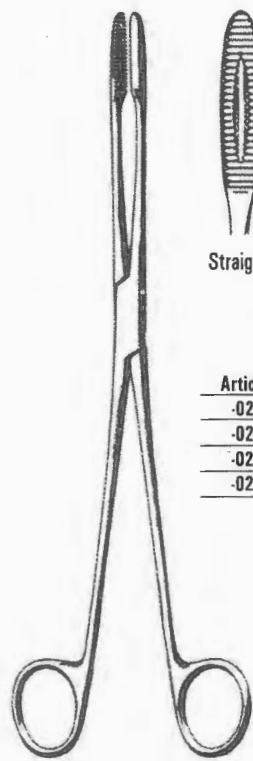

Gross-Maier Dressing Forceps

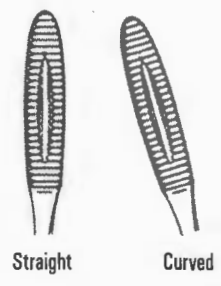

Straight Curved

Article #	Size
-02S-178	8" (20 cm)
-02S-179	9" (23 cm)
-02S-180	10" (25 cm)
-02S-181	10 1/2" (27 cm)

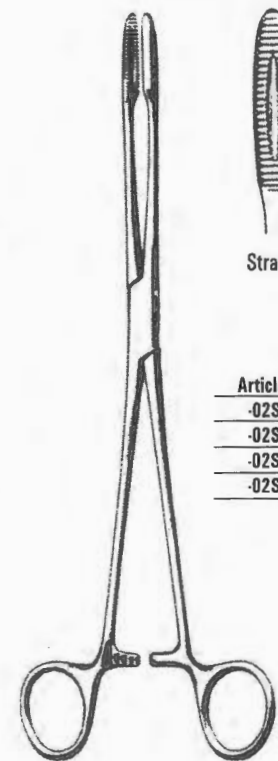

Gross-Maier Dressing Forceps

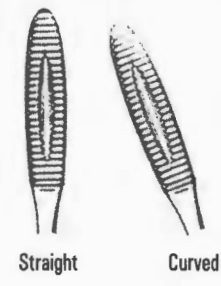

Straight Curved

Article #	Size
-02S-182	8" (20 cm)
-02S-183	9" (23 cm)
-02S-184	10" (25 cm)
-02S-185	10 1/2" (27 cm)

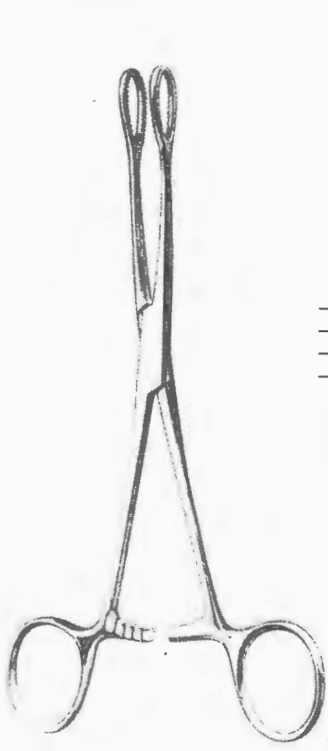

Foerster Spong Forceps

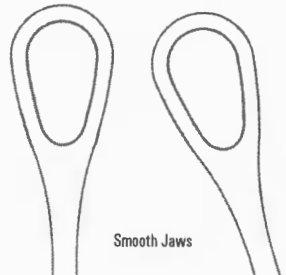

Smooth Jaws

Article #	Size	Article #	Size
-02S-186	7" (18 cm)	-02S-189	7" (18 cm)
-02S-187	8" (20 cm)	-02S-190	8" (20 cm)
-02S-188	10" (25 cm)	-02S-191	10" (25 cm)

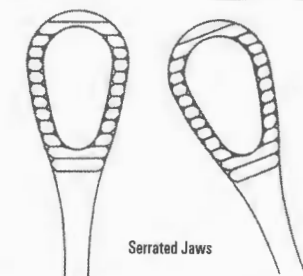

Serrated Jaws

Article #	Size	Article #	Size
-02S-192	7" (18 cm)	-02S-195	7" (18 cm)
-02S-193	8" (20 cm)	-02S-196	8" (20 cm)
-02S-194	10" (25 cm)	-02S-197	10" (25 cm)

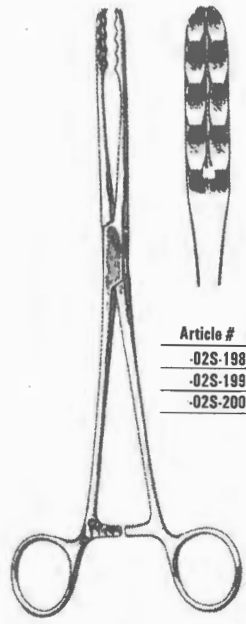

Ulrich Cotton Swab Forceps



Article #	Size
-02S-198	9" (23 cm)
-02S-199	10" (25 cm)
-02S-200	10 1/2" (27 cm)

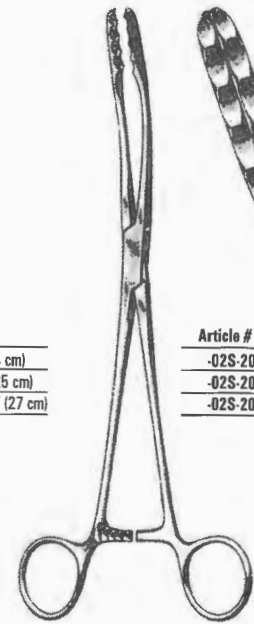

Ulrich Cotton Swab Forceps

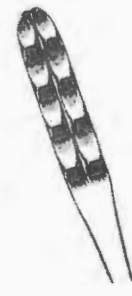

Article #	Size
-02S-201	9" (23 cm)
-02S-202	10" (25 cm)
-02S-203	10 1/2" (27 cm)

# TOWEL CLAMPS

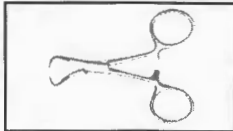

03S

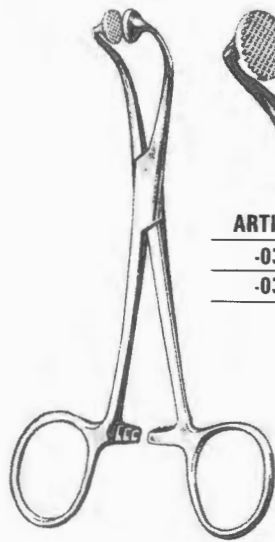

Hoff Towel Clamp  
Stainless Steel

ARTICLE #	SIZE
-03S-001	4" (10 cm)
-03S-002	5 1/4" (14.5 cm)



-03S-003  
Roeder Towel Clamp  
with Ball Stop  
5" (13 cm)



-03S-004  
Jones Towel Clamp  
3 1/2" (9 cm)



-03S-005  
Schaedel Towel Clamp  
3 1/2" (9 cm)



Ball & Socket Towel Clamp

ARTICLE #	SIZE
-03S-006	3 3/4" (10 cm)
-03S-007	5 1/2" (14 cm)
-03S-008	6" (15 cm)

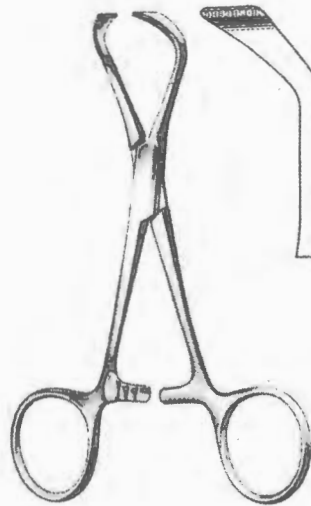

Lorna Towel Clamp

ARTICLE #	SIZE
-03S-009	4" (10 cm)
-03S-010	5" (13 cm)

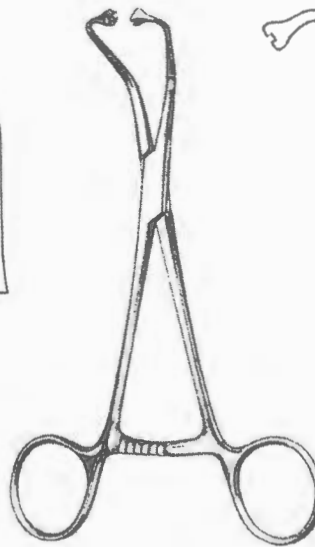

-03S-011  
Peers Towel Clamp  
5 1/4" (14.5 cm)

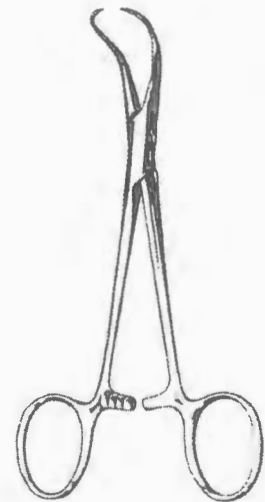

Backhaus Towel Clamp

ARTICLE #	SIZE
-03S-012	3.5" (9 cm)
-03S-013	4 1/2" (11 cm)
-03S-014	5" (13 cm)
-03S-015	6" (15 cm)

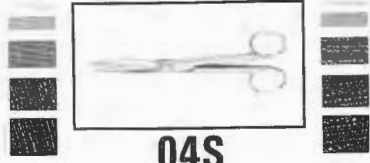

# SCISSORS

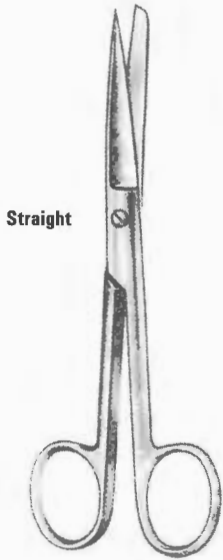

**Straight**

**Operating Scissors**

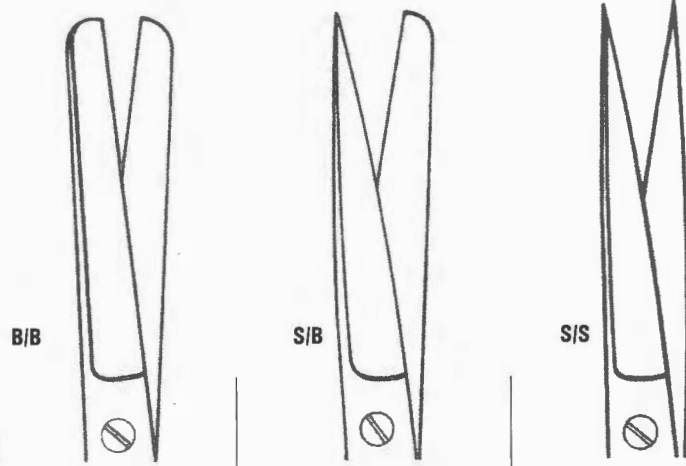

SIZE	B/B	S/B	S/S
4 1/4" (10.5 cm)	-04S-001	-04S-010	-04S-019
4 3/4" (11.5 cm)	-04S-002	-04S-011	-04S-020
5" (13.0 cm)	-04S-003	-04S-012	-04S-021
5 1/2" (14.5 cm)	-04S-004	-04S-013	-04S-022
6" (15.5 cm)	-04S-005	-04S-014	-04S-023
6 1/2" (16.5 cm)	-04S-006	-04S-015	-04S-024
7" (17.5 cm)	-04S-007	-04S-016	-04S-025
7 1/4" (18.5 cm)	-04S-008	-04S-017	-04S-026
8" (20.0 cm)	-04S-009	-04S-018	-04S-027

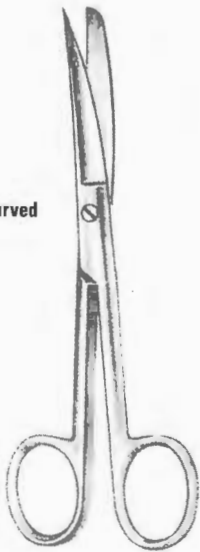

**Curved**

**Operating Scissors**

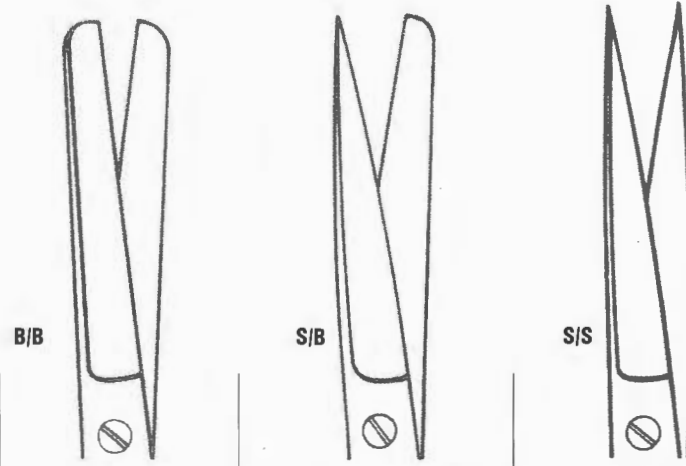

SIZE	B/B	S/B	S/S
4 1/4" (10.5 cm)	-04S-028	-04S-037	-04S-046
4 3/4" (11.5 cm)	-04S-029	-04S-038	-04S-047
5" (13.0 cm)	-04S-030	-04S-039	-04S-048
5 1/2" (14.5 cm)	-04S-031	-04S-040	-04S-049
6" (15.5 cm)	-04S-032	-04S-041	-04S-050
6 1/2" (16.5 cm)	-04S-033	-04S-042	-04S-051
7" (17.5 cm)	-04S-034	-04S-043	-04S-052
7 1/4" (18.5 cm)	-04S-035	-04S-044	-04S-053
8" (20.0 cm)	-04S-036	-04S-045	-04S-054



# SCISSORS

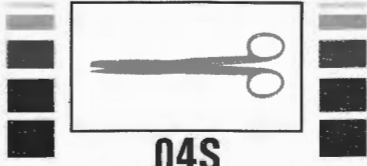

## Straight

## Curved

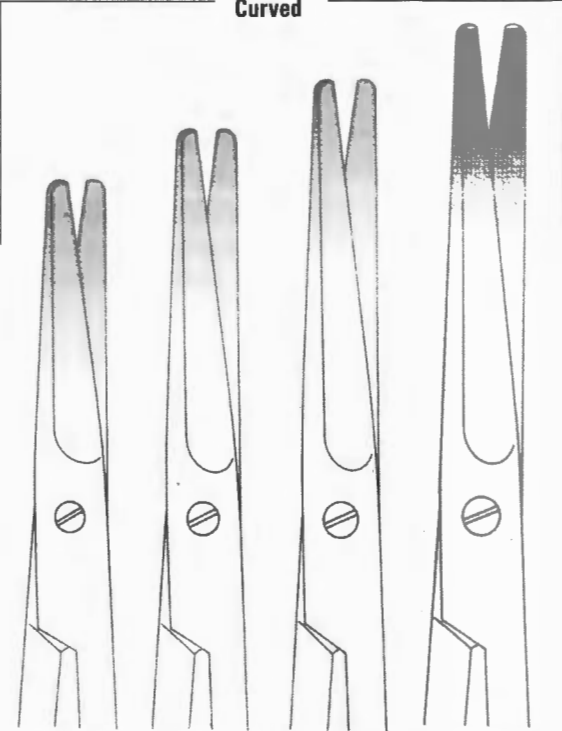
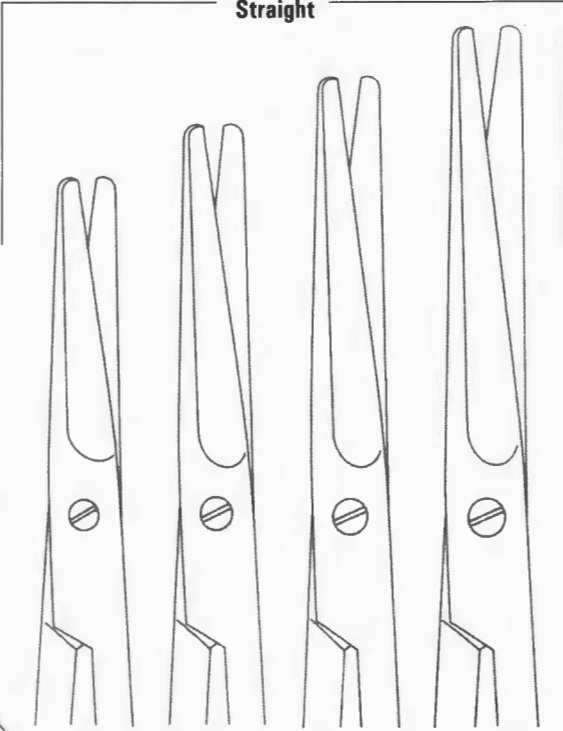
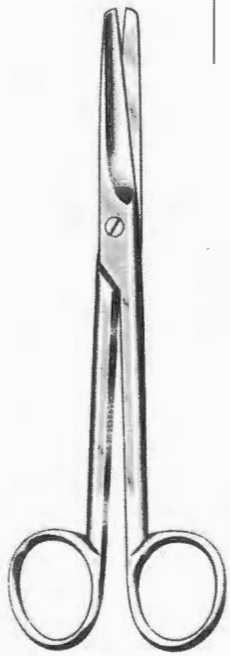

-04S-055 5 1/2" (14.5 cm)  
 -04S-056 6" (15 cm)  
 -04S-057 6 3/4" (17 cm)  
 -04S-058 9" (23 cm)

-04S-059 5 1/2" (14.5 cm)  
 -04S-060 6" (15 cm)  
 -04S-061 6 3/4" (17 cm)  
 -04S-062 9" (23 cm)

Mayo Dressing Scissors

## Straight

## Curved

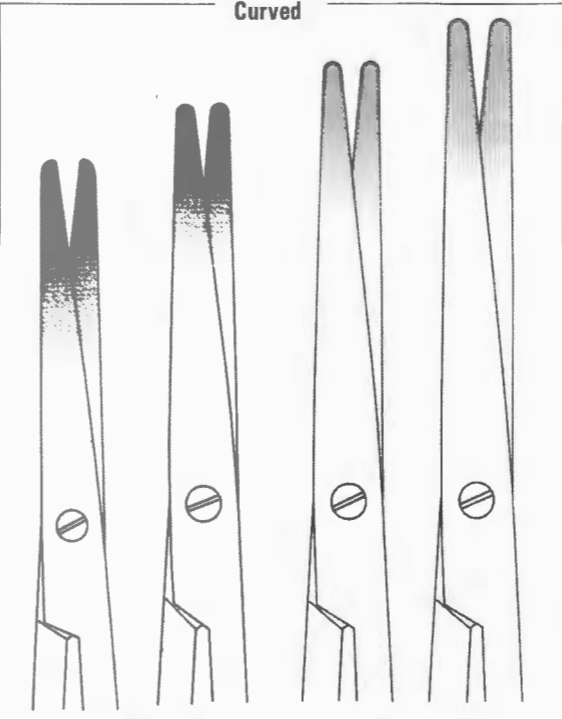
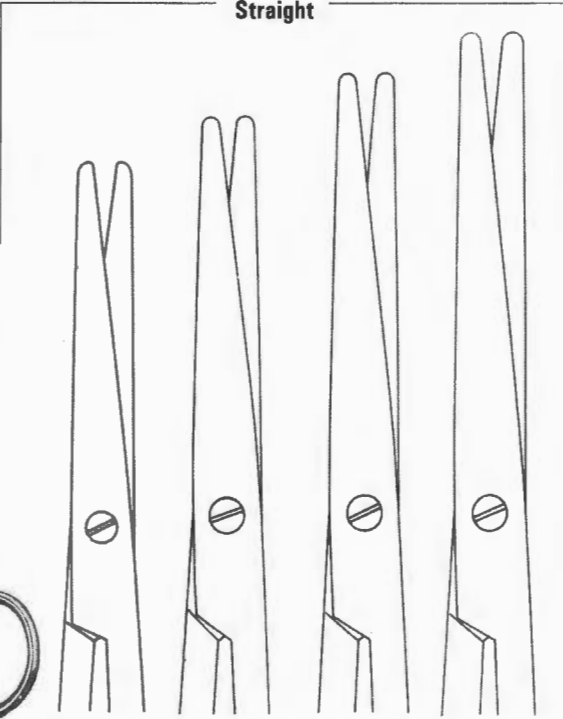
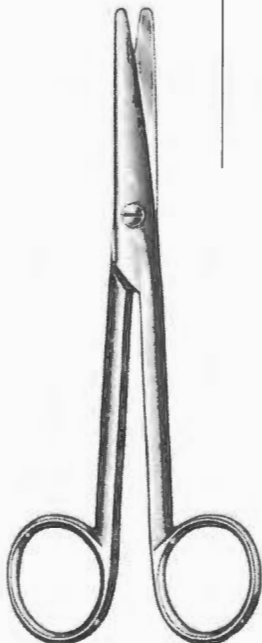

-04S-063 6" (15 cm)  
 -04S-064 6 1/4" (16 cm)  
 -04S-065 7 1/2" (19 cm)  
 -04S-066 8 1/2" (21 cm)

-04S-067 6" (15 cm)  
 -04S-068 6 1/4" (16 cm)  
 -04S-069 7 1/2" (19 cm)  
 -04S-070 8 1/2" (21 cm)

Mayo-Stillé Dressing Scissors



04S

# SCISSORS

Straight

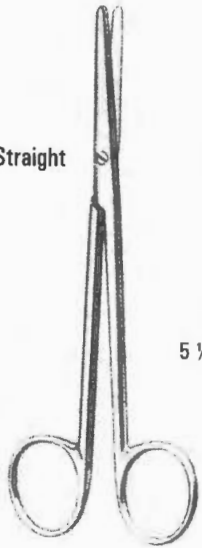

Metzenbaum Scissors



-04S-071  
5 1/2" (14 cm)

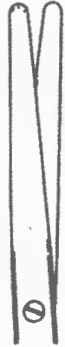

-04S-072  
7" (18 cm)



-04S-073  
8" (20 cm)



-04S-074  
9" (23 cm)



-04S-075  
10" (25 cm)



-04S-076  
11" (28 cm)



-04S-077  
12" (30 cm)

Curved

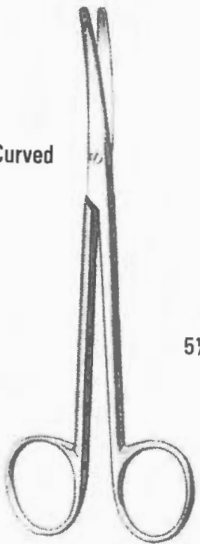

Metzenbaum Scissors



-04S-078  
5 1/2" (14 cm)



-04S-079  
7" (18 cm)



-04S-080  
8" (20 cm)



-04S-081  
9" (23 cm)



-04S-082  
10" (25 cm)

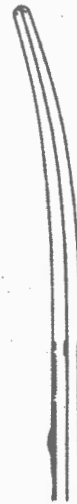

-04S-083  
11" (28 cm)



-04S-084  
12" (30 cm)

# SCISSORS

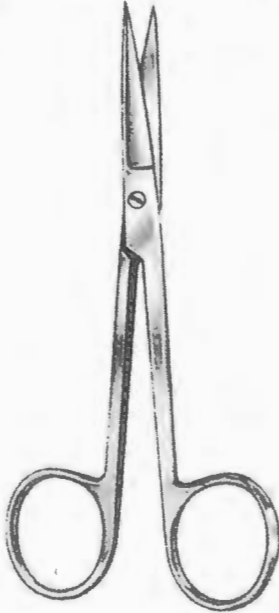
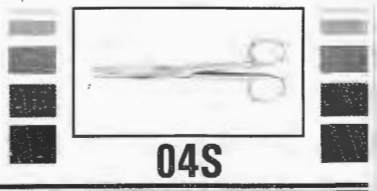

**Iris Scissors**

ARTICLE # Straight	ARTICLE # Curved	SIZE
-04S-085	-04S-088	3 1/2" (9 cm)
-04S-086	-04S-089	4" (10 cm)
-04S-087	-04S-090	4 1/2" (11 cm)

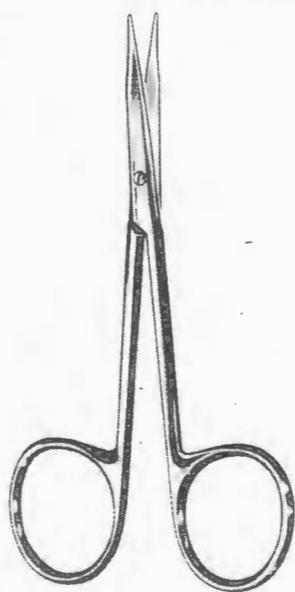

**Stevens Strabismus Scissors**

ARTICLE # Straight	ARTICLE # Curved	SIZE
-04S-091	-04S-093	4" (10 cm)
-04S-092	-04S-094	4 1/2" (11 cm)

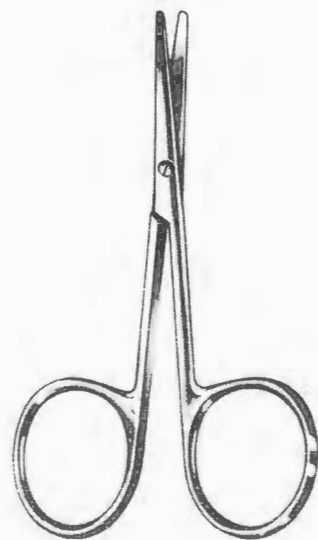

**Lexer-Baby Scissors**

ARTICLE # Straight	SIZE
-04S-095	4 1/4" (11 cm)
-04S-096	5" (12,5 cm)

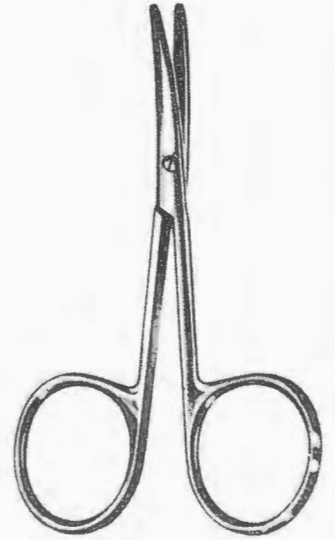

**Lexer-Baby Scissors**

ARTICLE # Curved	SIZE
-04S-097	4 1/4" (11 cm)
-04S-098	5" (12,5 cm)

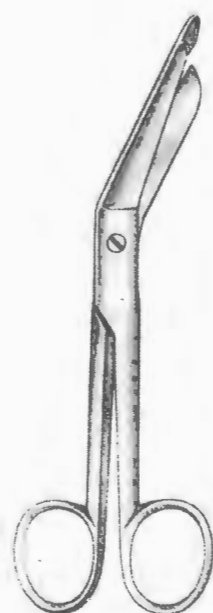

**Lister Bandage Scissors**

ARTICLE #	SIZE
-04S-099	3 1/2" (9 cm)
-04S-100	4 1/2" (11 cm)
-04S-101	5 1/2" (14 cm)
-04S-102	7" (18 cm)
-04S-103	8" (20 cm)

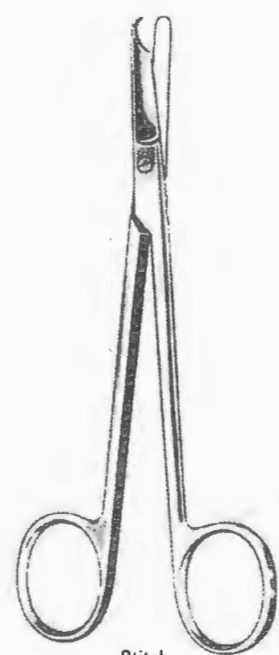

**Stitch  
Ligature Scissors**

ARTICLE #	SIZE
-04S-104	3 1/2" (9 cm)
-04S-105	4 1/2" (11 cm)
-04S-106	5 1/2" (14 cm)

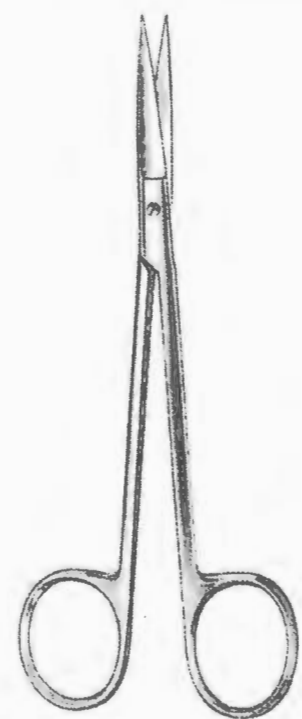

**-04S-107  
Joseph Scissors  
5 3/4" (14.5 cm)**

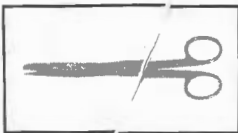

04S

# SCISSORS

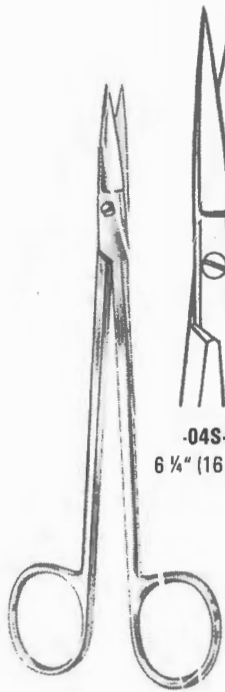

Kelly Scissors

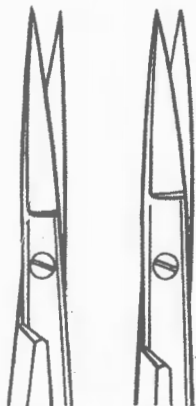

**-04S-108**  
6 1/4" (16 cm)

**-04S-109**  
7" (18 cm)

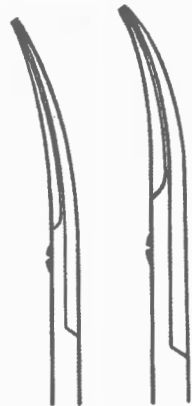

**-04S-110**  
6 1/2" (16 cm)

**-04S-111**  
7" (18 cm)

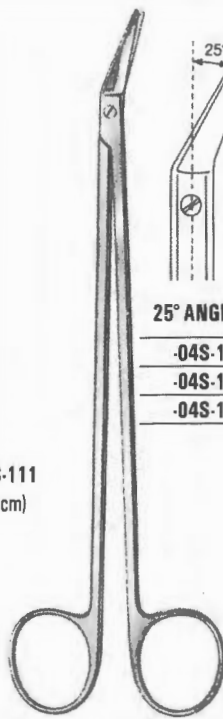

De-Bakey Scissors

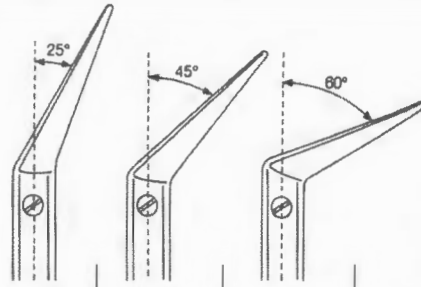

25° ANGEL	45° ANGEL	60° ANGEL	SIZE
<b>-04S-112</b>	<b>-04S-115</b>	<b>-04S-118</b>	6 1/2" (17 cm)
<b>-04S-113</b>	<b>-04S-116</b>	<b>-04S-119</b>	9" (23 cm)
<b>-04S-114</b>	<b>-04S-117</b>	<b>-04S-120</b>	11" (28 cm)

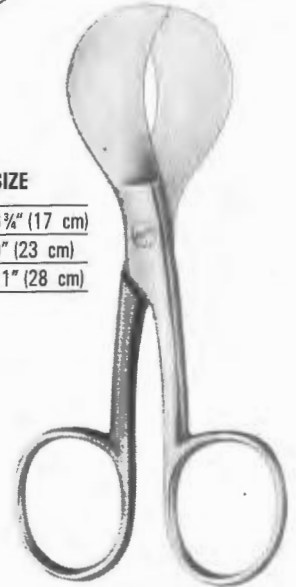

**-04S-121**  
US Umbilical Scissors  
4 1/2" (10,5 cm)

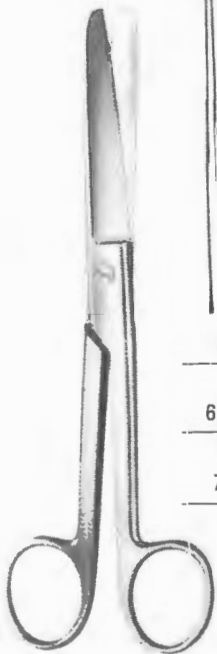

Doyen  
Abdominal Scissors



Straight	Curved
<b>-04S-122</b> 6 1/2" (16 cm)	<b>-04S-124</b> 6 1/2" (16 cm)
<b>-04S-123</b> 7" (18 cm)	<b>-04S-125</b> 7" (18 cm)

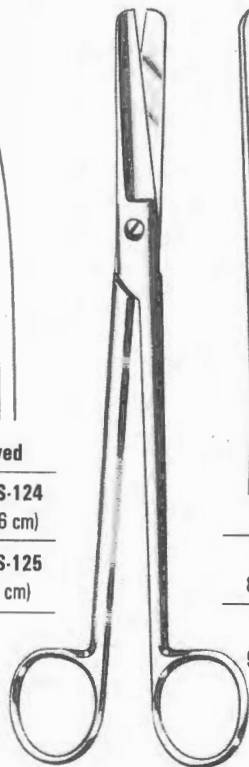

Parametrium Scissors

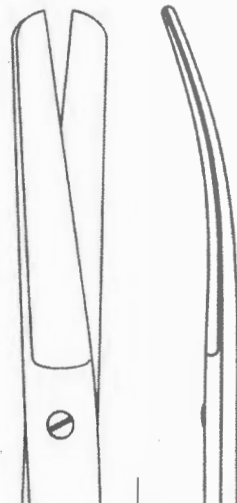

Straight	Curved
<b>-04S-126</b> 8" (20 cm)	<b>-04S-128</b> 8" (20 cm)
<b>-04S-127</b> 9" (23 cm)	<b>-04S-129</b> 9" (23 cm)

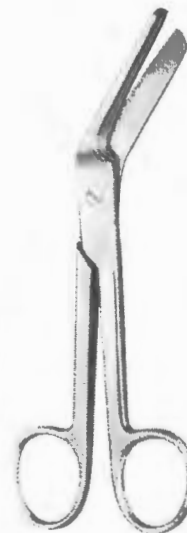

Braun-Stadler Scissors

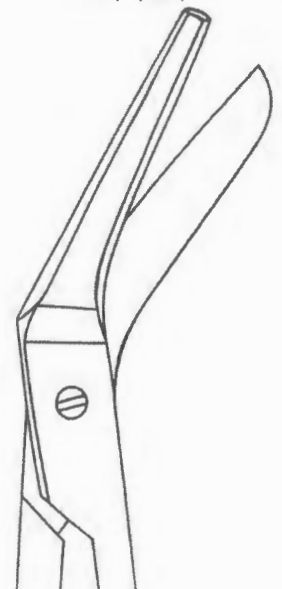

**-04S-130**  
5 1/2" (14 cm)

**-04S-131**  
8 1/2" (22 cm)

# DRESSING & TISSUE FORCEPS



05S

SERRATED

1X2 TEETH



Adson Forceps



-05S-001  
4 1/4" (12 cm)



-05S-002  
6" (15 cm)



-05S-003  
4 1/4" (12 cm)



-05S-004  
6" (15 cm)



-05S-005  
Adson-Brown Forceps  
4 1/4" (12 cm)



-05S-006  
Adson Forceps  
Serrated  
4 1/4" (12 cm)



-05S-007  
Adson Forceps  
1X2 TEETH  
4 1/4" (12 cm)



-05S-008  
Adson Forceps  
1X2 TEETH  
WITH TYING PLATFORM  
4 1/4" (12 cm)



-05S-009  
Adson Brown Forceps  
4 1/4" (12 cm)

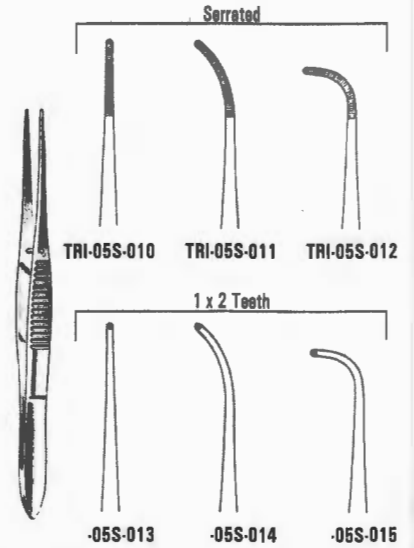

Splinter Forceps  
4 1/2" (11.5 cm)

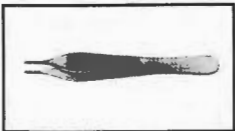

05S

# DRESSING & TISSUE FORCEPS

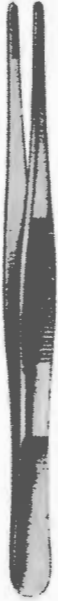

Dressing Forceps



**-05S-016**  
4½" (11.5 cm)



**-05S-017**  
5" (13 cm)



**-05S-018**  
5½" (14.5 cm)

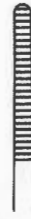

**-05S-019**  
6¼" (16 cm)

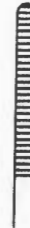

**-05S-020**  
7" (18 cm)



**-05S-021**  
8" (20 cm)



**-05S-022**  
10" (25 cm)



**-05S-023**  
12" (30 cm)



Tissue Forceps



**-05S-024**  
4¼" (11 cm)



**-05S-025**  
4½" (11.5 cm)



**-05S-026**  
5" (13 cm)



**-05S-027**  
5½" (14.5 cm)



**-05S-028**  
6¼" (16 cm)



**-05S-029**  
7" (18 cm)



**-05S-030**  
8" (20 cm)



**-05S-031**  
10" (25 cm)



**-05S-032**  
12" (30 cm)

# DRESSING & TISSUE FORCEPS

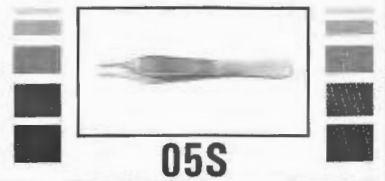

05S

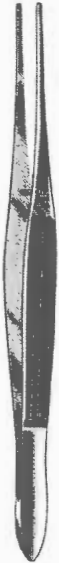

-05S-033  
6" (15 cm)

McIndoe Forceps



-05S-034  
6" (15 cm)

Gillies Dressing Forceps



Serrated  
-05S-035 5" (12.5 cm)  
-05S-036 6" (155 cm)

Semken Dressing & Tissue Forceps



1 x 2 Teeth

-05S-037 5" (12.5 cm)  
-05S-038 6" (155 cm)



-05S-039  
7" (17 cm)

Taylor Dressing & Tissue Forceps



-05S-040  
7" (17 cm)



Taylor Dressing & Tissue Forceps

-05S-041  
7" (18.5 cm)

-05S-042  
7" (18.5 cm)



Serrated

-05S-043  
7" (18 cm)

-05S-044  
7" (18 cm)

Gerald Dressing & Tissue Forceps

1 x 2 Teeth

-05S-045  
7" (18 cm)

-05S-046  
7" (18 cm)



Serrated  
-05S-047  
7" (17.5 cm)

-05S-048  
7" (17.5 cm)

Cushing Dressing & Tissue Forceps

1 x 2 Teeth

-05S-049  
7" (17.5 cm)

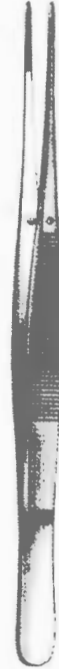

Serrated  
-05S-050  
7" (18 cm)

-05S-051  
8 1/4" (21 cm)

-05S-052  
10" (25 cm)

Potts-Smith Dressing & Tissue Forceps

1 x 2 Teeth

-05S-053  
7" (18 cm)

-05S-054  
8 1/4" (21 cm)

-05S-055  
10" (25 cm)



05S

# DRESSING & TISSUE FORCEPS



Durante Tissue Forceps

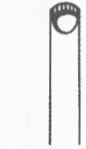

-05S-056  
5½" (14.5 cm)



-05S-057  
6¾" (16 cm)

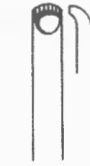

-05S-058  
8" (20 cm)



Bonney Tissue Forceps



-05S-059  
7" (18 cm)



Stone Tissue Forceps



-05S-060  
6" (15 cm)

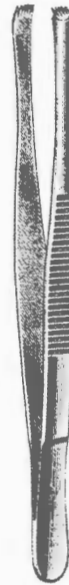

Lerche Tissue Forceps



-05S-061  
6" (15 cm)



Mayo-Russ.  
Tissue Forceps



-05S-062  
9" (23 cm)



Singley-Tuttle  
Tissue Forceps



-05S-063  
9" (23 cm)



Russ. Modell  
Tissue Forceps



-05S-064  
6" (15 cm)



-05S-065  
8" (20 cm)



-05S-066  
10" (25 cm)



Duval  
Tissue Forceps



-05S-067  
5½" (14.5 cm)

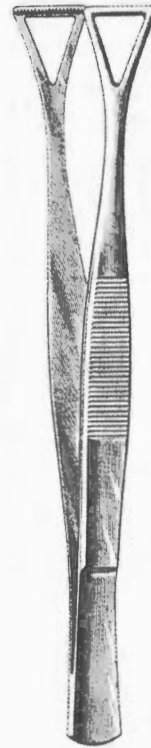

Collin-Duval  
Grasping Forceps



-05S-068  
8" (20 cm)



**DRESSING & TISSUE FORCEPS**

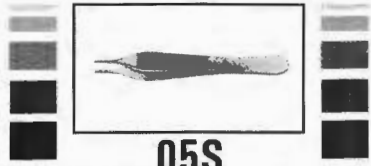

**-05S-069**  
Carhalt Splinter Forceps  
4 1/4" (11 cm)



**-05S-070**  
Carhalt Splinter Forceps  
4 1/4" (11 cm)



Walter Splinter Forceps



**-05S-071**  
4 1/2" (11.5 cm)



**-05S-072**  
4 1/2" (11.5 cm)



**-05S-073**  
Feilchenfeld  
Splinter Forceps 3" (8 cm)



**-05S-074**  
Splinter Forceps  
with Magnify Glass  
3" (8 cm)



Physicians Splinter Forceps



**-05S-075**  
5" (12.5 cm)

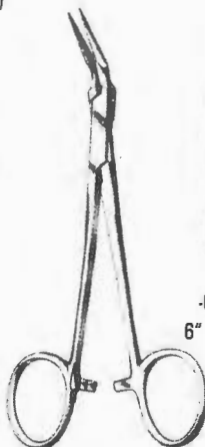

Williams Splinter Forceps



**-05S-076**  
6" (15 cm)



**-05S-077**  
6" (15 cm)

**-05S-078**  
5 1/2" (14 cm)



Virtus Splinter



**-05S-079**  
5 1/2"

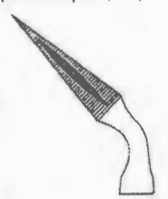

**-05S-080**  
5 1/2"

**Swiss Jeweler Forceps**

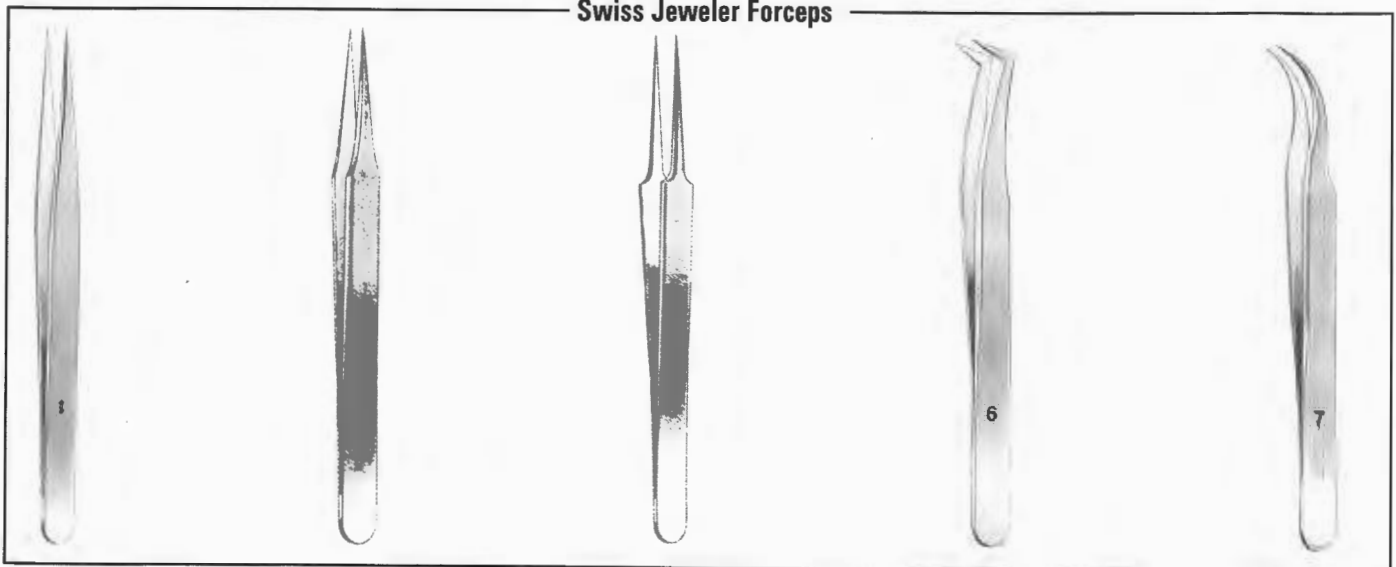

**-05S-081**  
4 3/4" (12 cm)

**-05S-082**  
4 3/4" (12 cm)

**-05S-083**  
4 3/4" (12 cm)

**-05S-084**  
4 3/4" (12 cm)

**-05S-085**  
4 3/4" (12 cm)

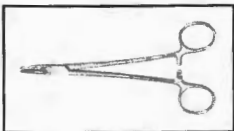

06S

# NEEDLE HOLDER

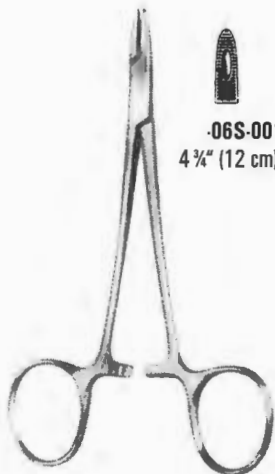

Derf Needle Holder



**-06S-001**  
4 ¼" (12 cm)



**-06S-002**  
5" (12.5 cm)



**-06S-003**  
Collier Needle Holder  
5" (12.5 cm)

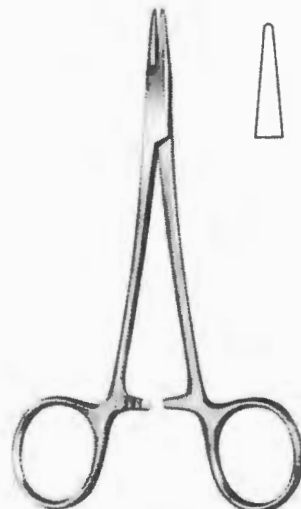

**-06S-004**  
Webster Needle Holder  
5" (13 cm)

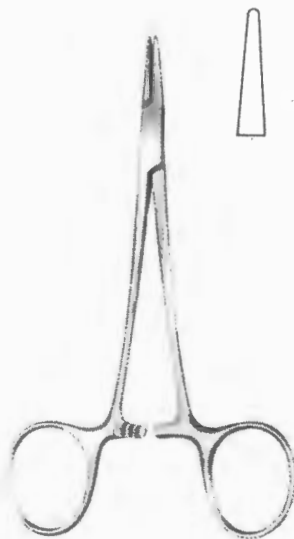

**-06S-005**  
Halsey Needle Holder  
5" (13 cm)



**-06S-006**  
Neivert Needle Holder  
5" (13 cm)

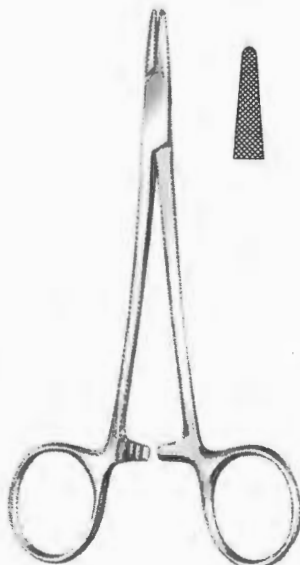
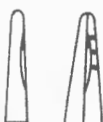

**-06S-007**  
Hegar-Baumgartner Needle Holder  
5 ½" (14 cm)



Brown Needle Holder



ARTICLE #	SIZE
<b>-06S-008</b>	5" (12.5 cm)
<b>-06S-009</b>	7" (18 cm)

# NEEDLE HOLDER



06S

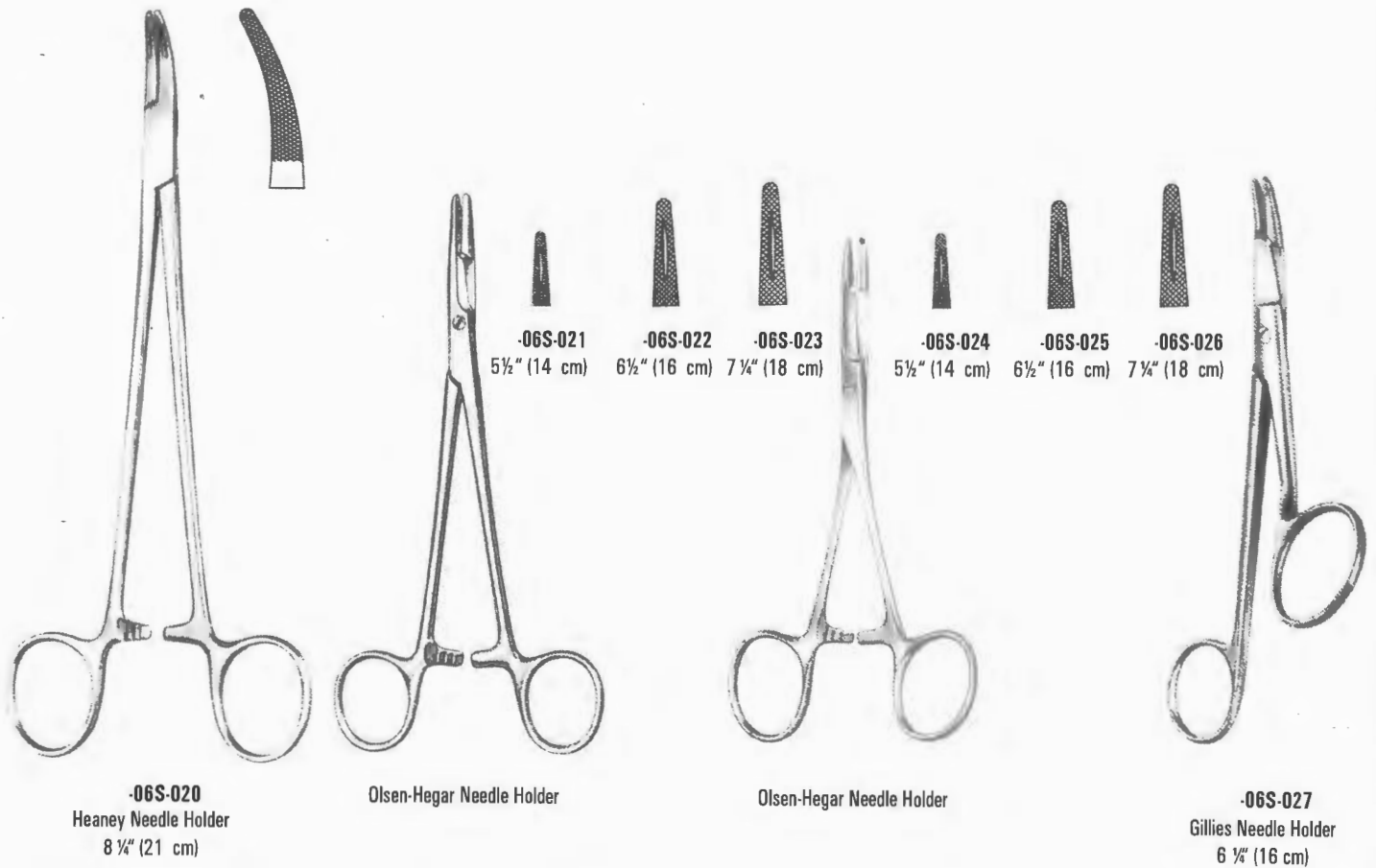
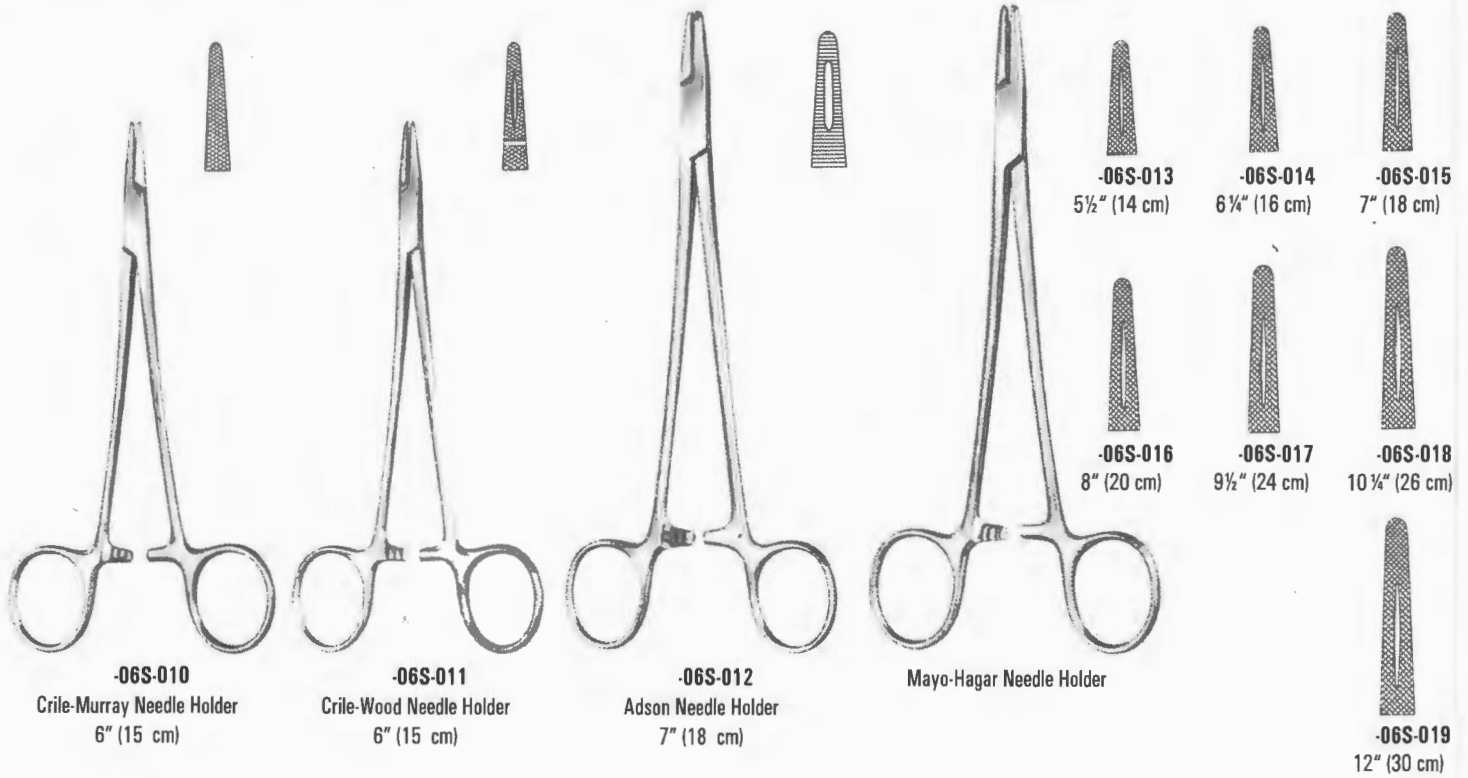

# NEEDLE HOLDER

06S

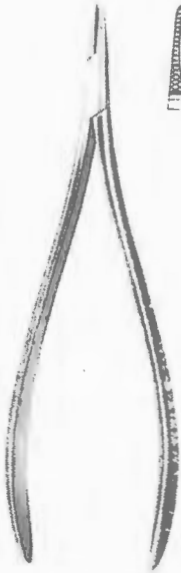

**-06S-028**  
Crile Needle Holder  
6" (15 cm)



Mathieu Needle Holder



**-06S-029**  
5½" (14 cm)



**-06S-030**  
6¾" (17 cm)



**-06S-031**  
8" (20 cm)



Mathieu Needle Holder



**-06S-032**  
5½" (14 cm)



**-06S-033**  
6¾" (17 cm)

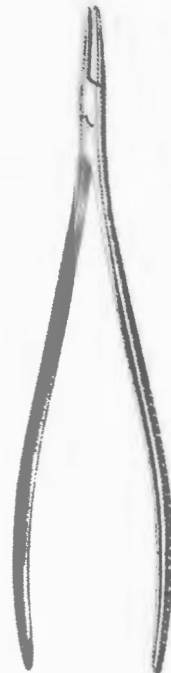

**-06S-034**  
Toennis Needle Holder  
7" (18 cm)

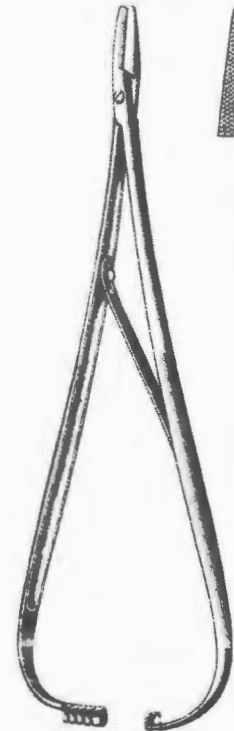

**-06S-035**  
Lichtenberg Needle Holder  
8" (20 cm)



# RETRACTORS

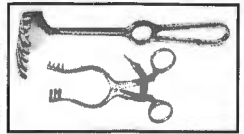

07S

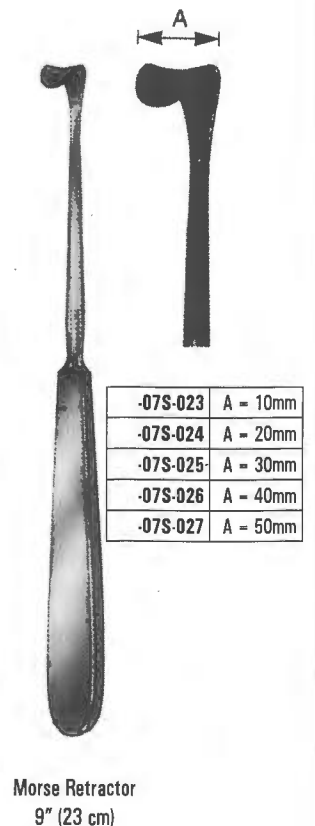
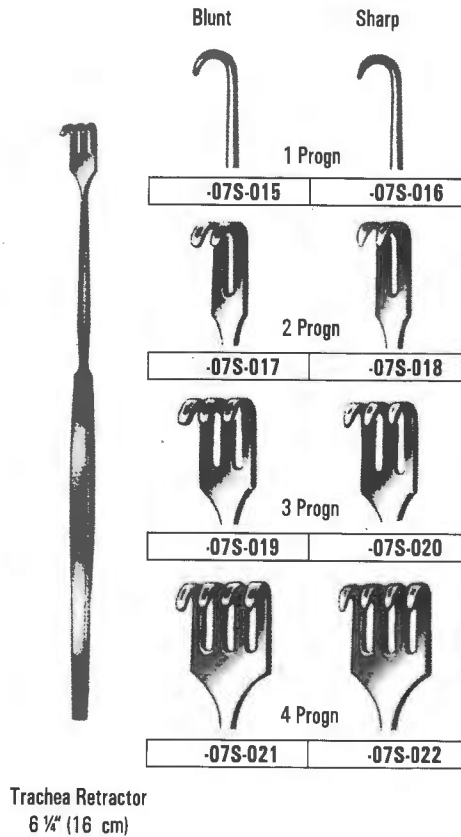
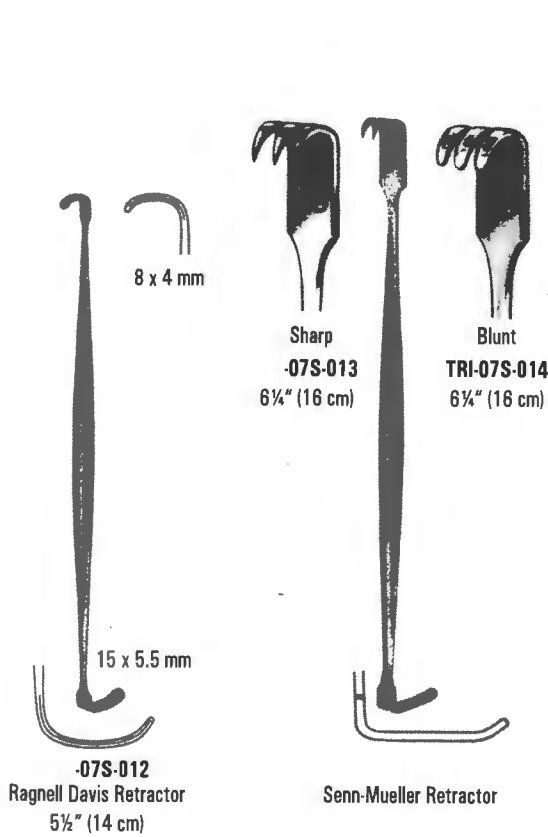
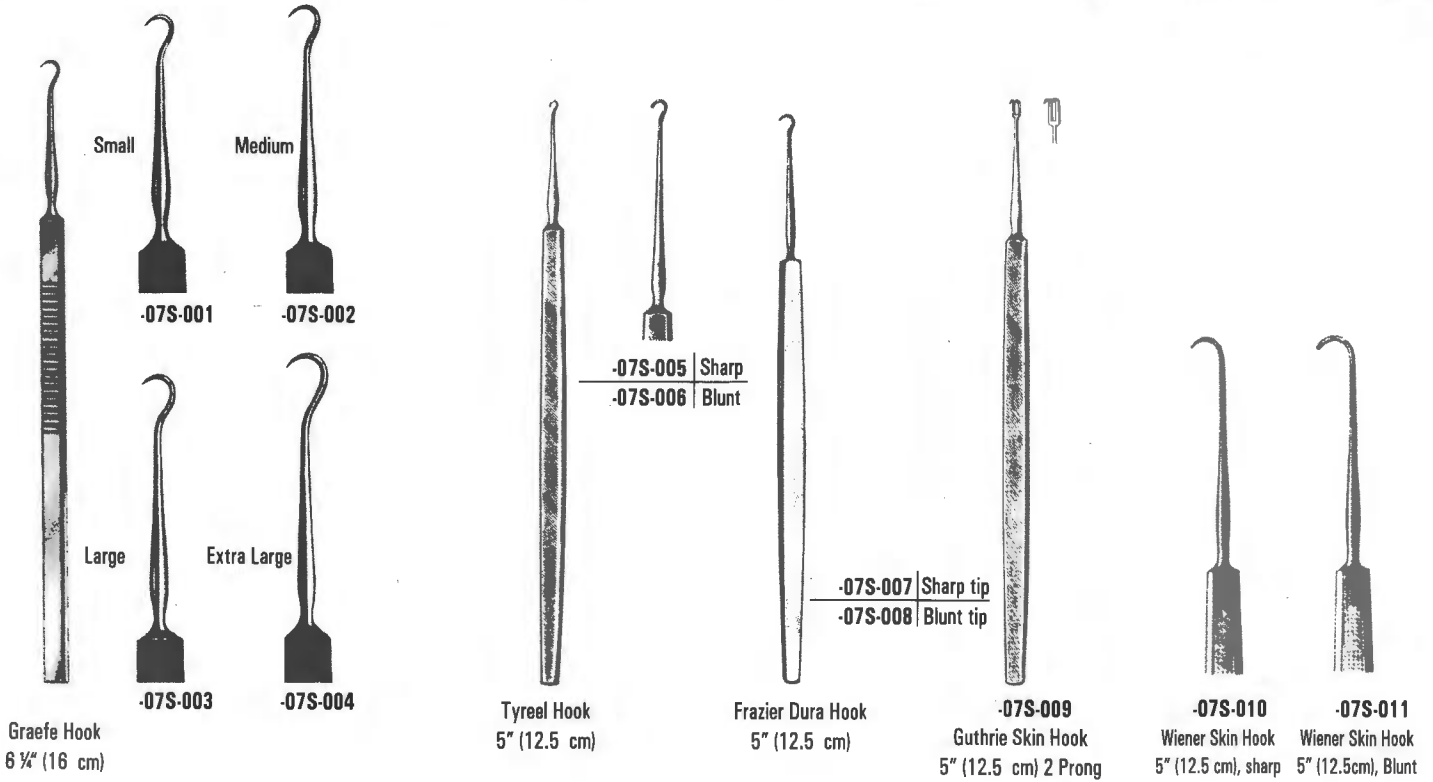

# RETRACTORS

07S



Desmarres Retractor  
6 1/4" (16 cm)



Fig. 2 - 49x38mm  
Fig. 1 - 28x20mm



Fig. 1 - 36x28mm  
Fig. 2 - 71x43mm  
**-07S-034**  
Richardson-Eastman

Fig. 2 - 25x15mm  
Fig. 1 - 21x15mm



Fig. 1 - 40x15mm  
Fig. 2 - 45x15mm  
**-07S-035**  
US-Army (Parker-Langenbeck)  
8 1/4" (21 cm)

Fig. 2 - 30x10mm 27x16mm  
Fig. 1 - 26x10mm 23x16mm



Fig. 1 - 30x13mm 26x16mm  
Fig. 2 - 34x13mm 30x16mm  
**-07S-036** **-07S-037**  
Farabeuf Farabeuf  
4 1/4" (12 cm) 6" (15 cm)



5" (13 cm)

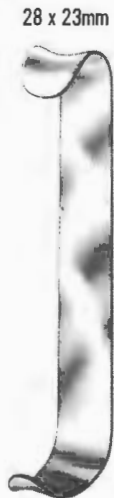

6 1/2" (16.5 cm)



7" (18 cm)



Mini-Roux Retractor  
6" (15 cm)



Roux Retractor 6 1/4"  
(Complete Set)

# RETRACTORS



07S

## Deaver Retractor

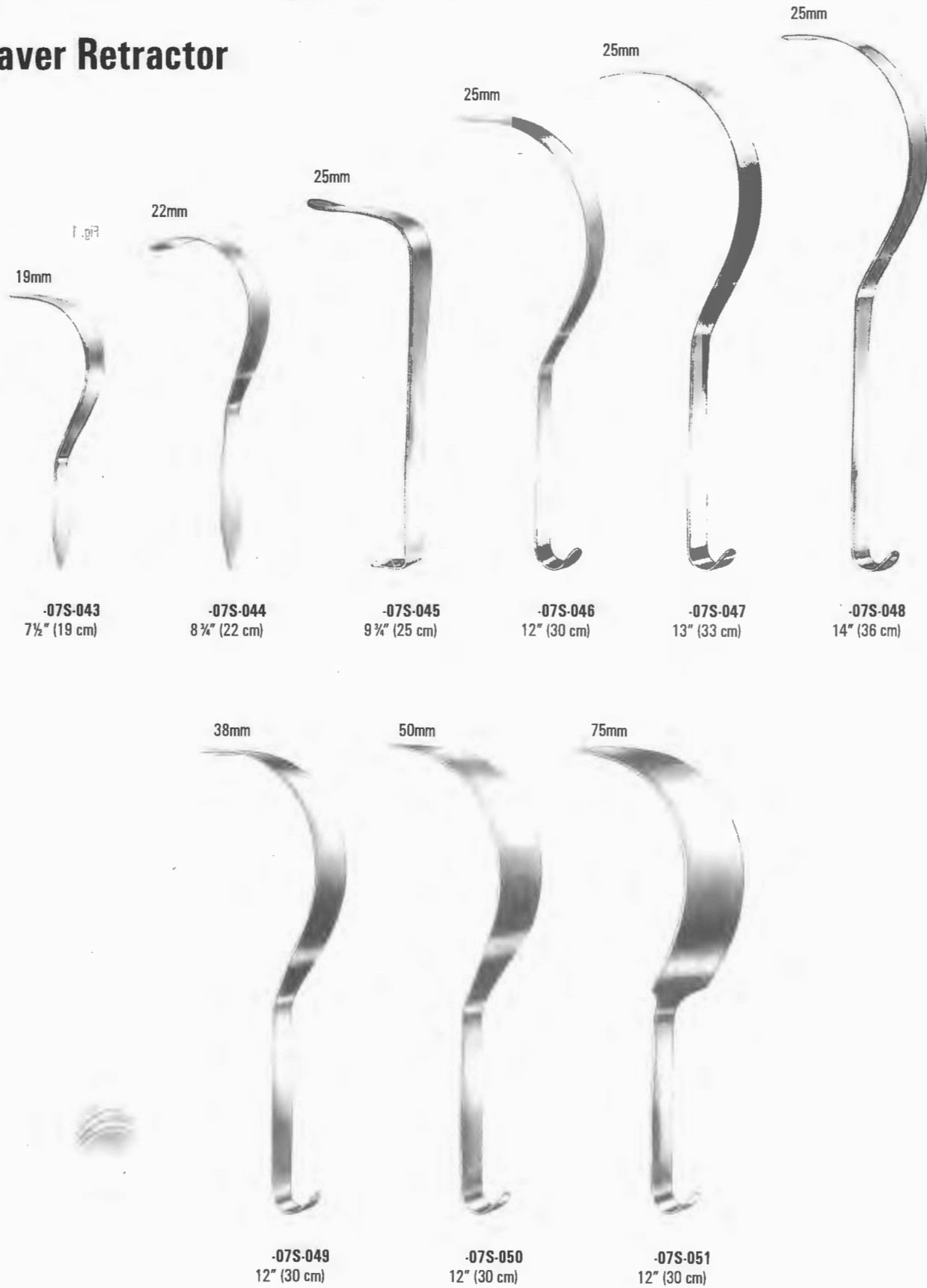

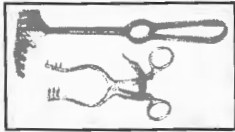

07S

# RETRACTORS



Volkman Retractor

	9 x 8mm	9 x 13mm	9 x 19mm	9 x 29mm	9 x 40mm		
Sharp							
	-07S-052	-07S-053	-07S-054	-07S-055	-07S-056	-07S-057	
							8 1/2" (21.5 cm)
Blunt							
	-07S-058	-07S-059	-07S-060	-07S-061	-07S-062	-07S-063	
							8 1/2" (21.5 cm)
Semi-Blunt							
	-07S-064	-07S-065	-07S-066	-07S-067	-07S-068	-07S-069	
							8 1/2" (21.5 cm)



Mini Langenbeck Retractor  
6 1/4" (16 cm)

10 x 6mm	20 x 6mm
-07S-070	-07S-071
75 x 5mm	28 x 8mm
-07S-072	-07S-073

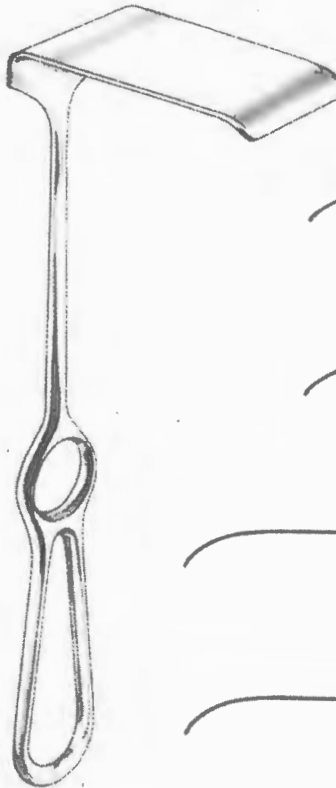

Kocher Retractor  
9" (23 cm)

	-07S-074 40 x 18mm
	-07S-075 60 x 20mm
	-07S-076 60 x 25mm
	-07S-077 75 x 30mm
	-07S-078 75 x 40mm



# RETRACTORS

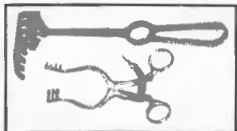

07S



Kocher-Langenbeck Retractor  
8½" (21.5 cm)



-07S-083  
35 x 15mm



-07S-084  
40 x 11mm



-07S-085  
55 x 11mm



-07S-079  
25 x 6mm



-07S-080  
25 x 8mm



-07S-081  
35 x 8mm



-07S-082  
35 x 11mm

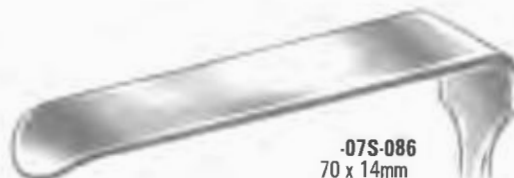

-07S-086  
70 x 14mm



-07S-087  
80 x 12mm



-07S-088  
80 x 16mm

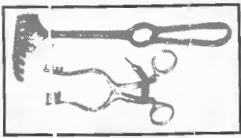

07S

# RETRACTORS

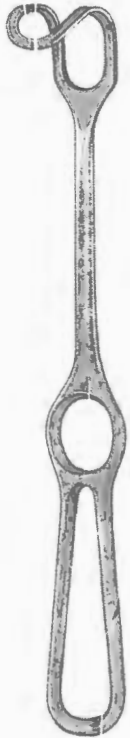

Middeldorpf Retractor

ARTICLE #	WIDE	SIZE
-07S-089	14x17mm	8 1/4" (21.5 cm)
-07S-090	20x22mm	8 3/4" (22.0 cm)
-07S-091	26x30mm	9" (23.5 cm)

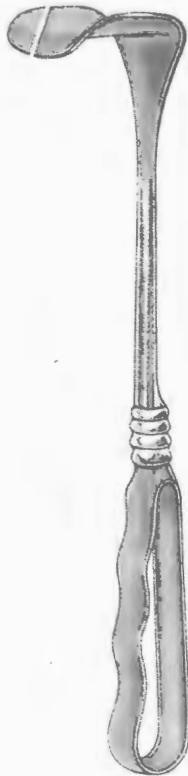

Richardson Retractor

ARTICLE #	WIDE	SIZE
-07S-092	28x20mm	9" (24 cm)
-07S-093	36x28mm	9" (24 cm)
-07S-094	44x38mm	9" (24 cm)
-07S-095	52x22mm	9" (24 cm)

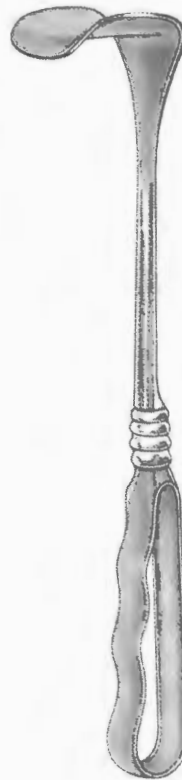

-07S-096

Kelly Retractor 65 x 50 mm  
10" (26 cm)



2 1/4" x 2"

-07S-097

Delee Retractor



Fritsch Retractor  
9 1/2" (24 cm)

ARTICLE #	WIDE
-07S-098	45x40mm
-07S-099	45x50mm
-07S-100	45x60mm
-07S-101	45x75mm
-07S-102	65x85mm



-07S-103  
Kocher Retractor  
8 3/4" (22.5 cm)



ARTICLE #	WIDE
-07S-104	80x42mm
-07S-105	80x50mm
-07S-106	80x60mm

Kocher Retractor  
9 1/4" (25 cm)

# RETRACTORS

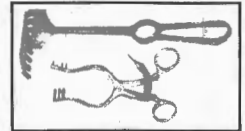

07S



Gelpi Retractor

ARTICLE #	SIZE
-07S-107	5" (13.5 cm)
-07S-108	7" (17.5 cm)

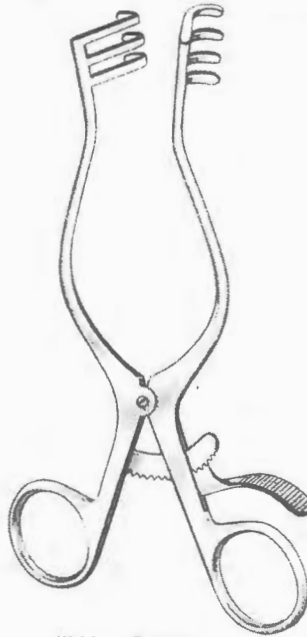

Weitlaner Retractor

Sharp	Blunt	Length	Prongs
-07S-109	-07S-114	4 1/4" (10 cm)	2 x 3
-07S-110	-07S-115	5" (13 cm)	3 x 4
-07S-111	-07S-116	6 1/4" (16 cm)	3 x 4
-07S-112	-07S-117	8" (20 cm)	3 x 4
-07S-113	-07S-118	9 1/4" (25 cm)	3 x 4

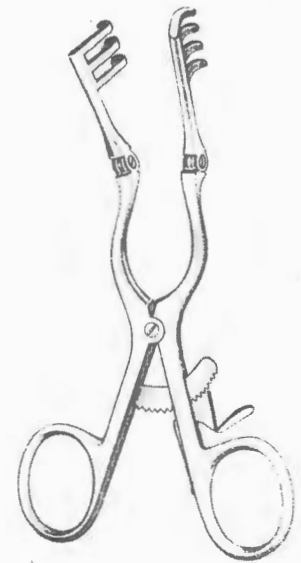

Cone Retractor

Sharp	Blunt	Length	Prongs
-07S-119	-07S-122	5" (13 cm)	3 x 4
-07S-120	-07S-123	6 1/4" (16 cm)	3 x 4
-07S-121	-07S-124	8" (20 cm)	3 x 4



Alm Retractor

Sharp	Blunt	Length
-07S-125	-07S-125	4" (10 cm)
-07S-126	-07S-126	2 3/4" (7 cm)

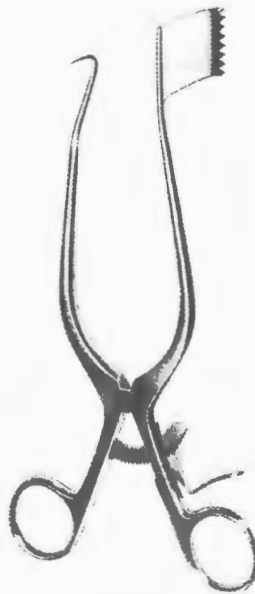

-07S-127  
Markham-Meyering Retractor  
7" (18 cm)

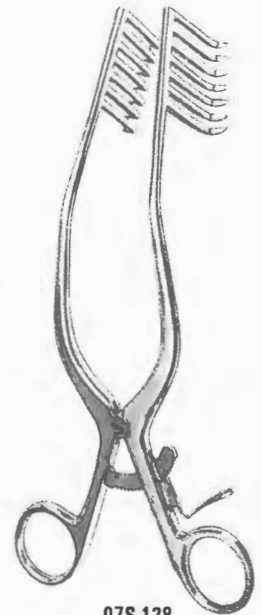

-07S-128  
Miskimon Retractor  
7 1/2" (19 cm)

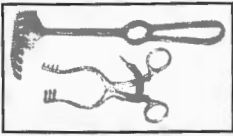

07S

# RETRACTORS

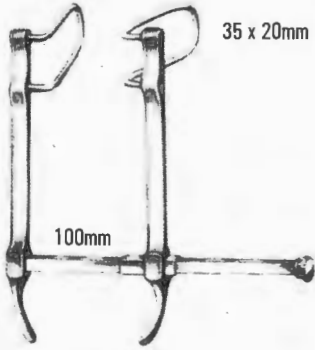

35 x 20mm

-07S-129  
Gosset Retractor

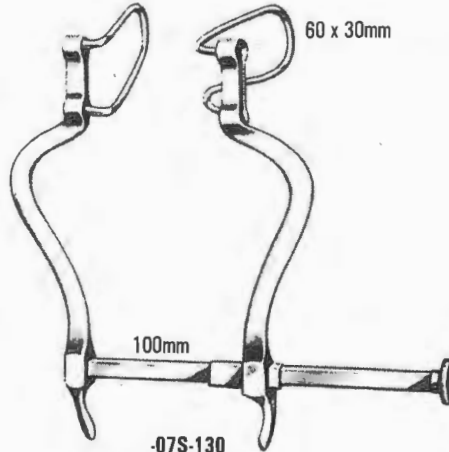

60 x 30mm

-07S-130  
Gosset Retractor



60 x 30mm

-07S-131  
Gosset Retractor

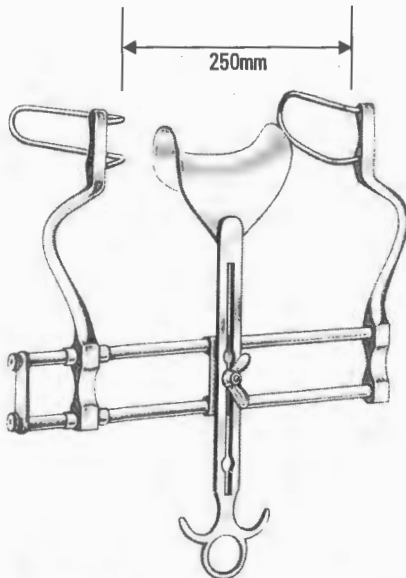

-07S-132  
Balfour Retractor

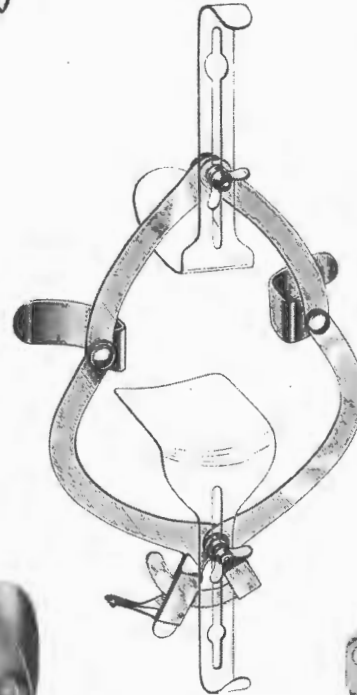

-07S-133  
O'Sullivan-O'Connor  
Abdominal Retractor

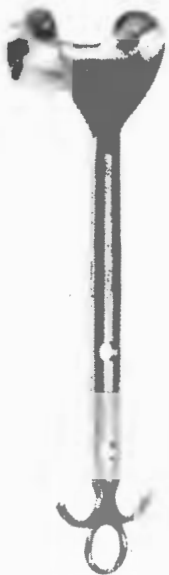

-07S-134  
Balfour Center Blade



-07S-135  
Collin Abdominal Retractor  
9" (23 cm)

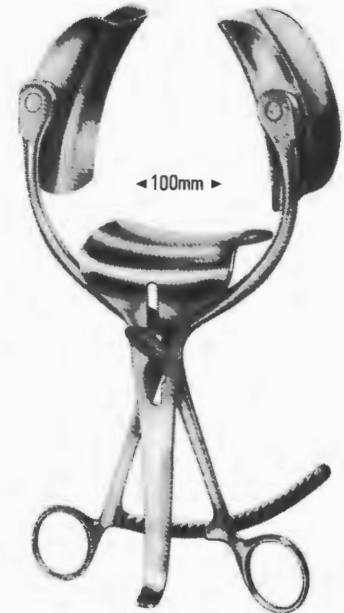

Collin Retractor

ARTICLE #	SIDE BLADE	CENTER BLADE
-07S-136	38 x 60mm	38 x 55mm
-07S-137	38 x 80mm	50 x 75mm

# RETRACTORS

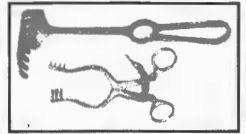

07S

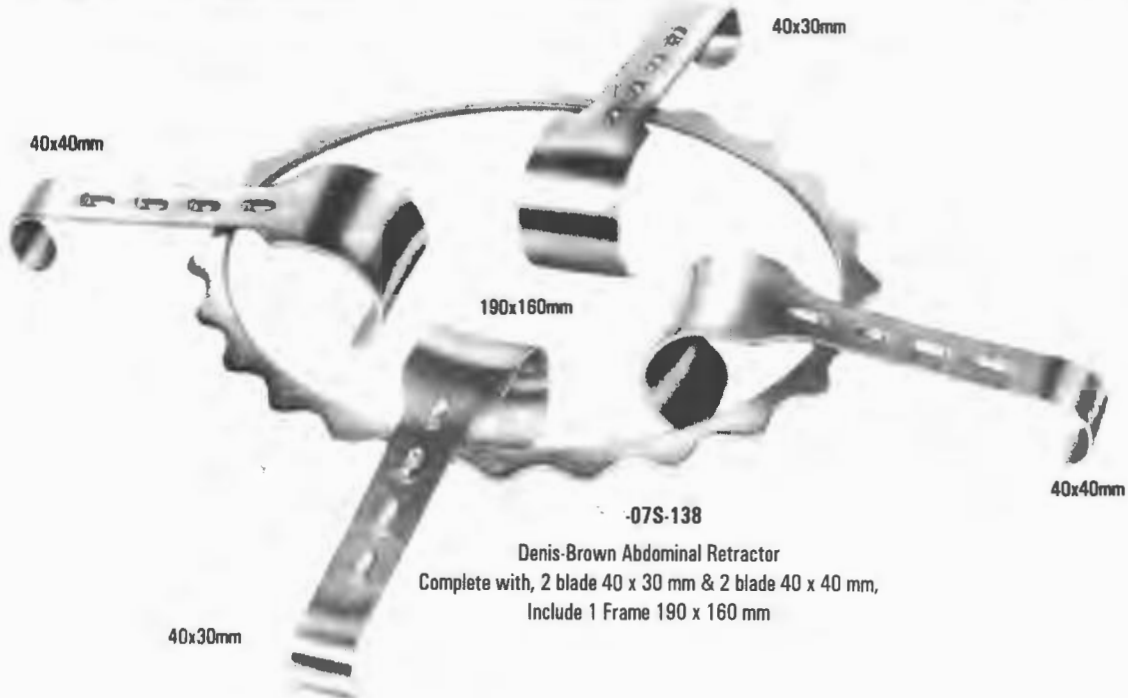

-07S-138

Denis-Brown Abdominal Retractor  
Complete with, 2 blade 40 x 30 mm & 2 blade 40 x 40 mm,  
Include 1 Frame 190 x 160 mm

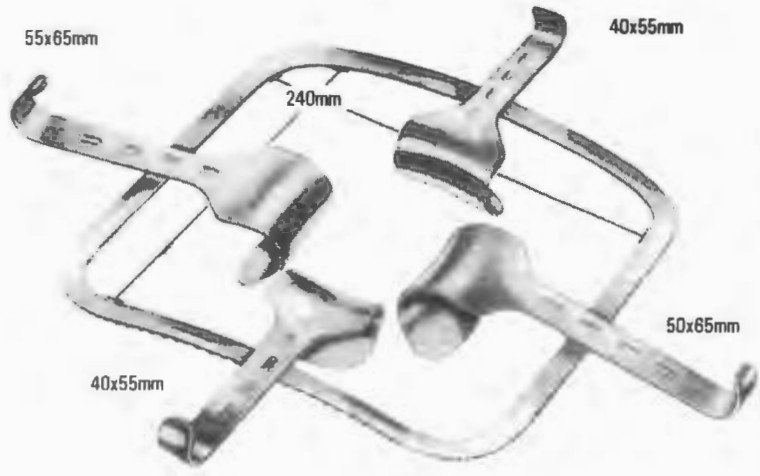

-07S-139

Kirschner Abdominal Retractor  
Complete with, 2 blade 40 x 35 mm & 2 blade 50 x 65 mm,  
Include 1 Frame Rigid, 240 x 240 mm



40x55mm

55x65mm

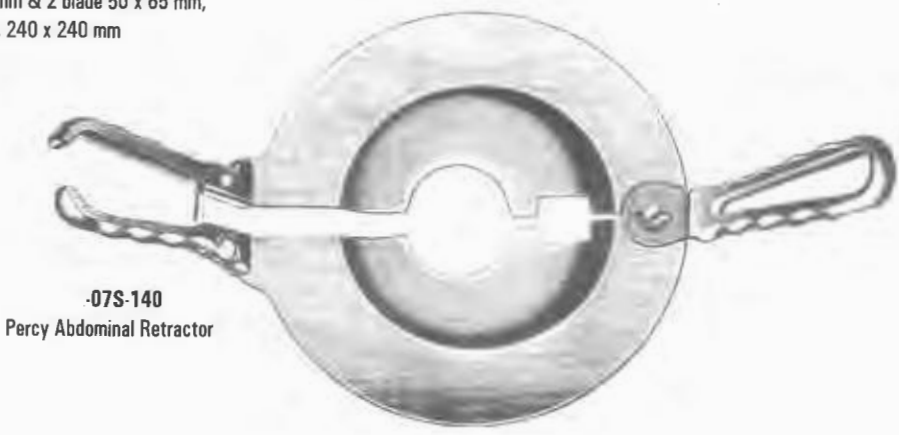

-07S-140

Percy Abdominal Retractor

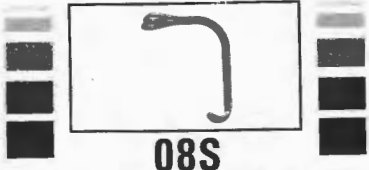

# ORAL INSTRUMENTS



**-08S-001**  
Tongue Depressors  
7½" (19 cm)

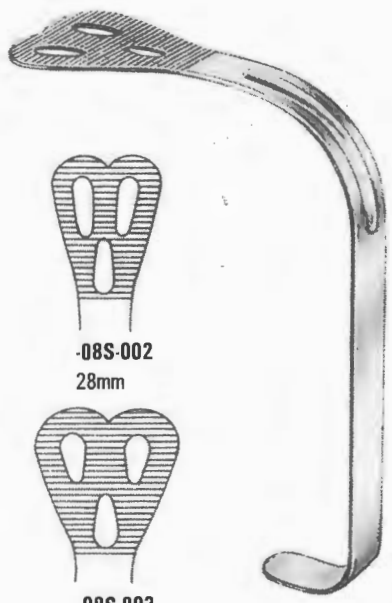

Wieder Tongue Depressors  
5½" (14 cm)



**-08S-002**  
28mm

**-08S-003**  
32mm

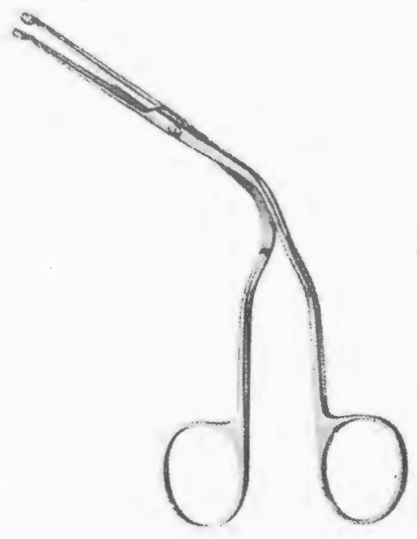

Magil Forceps

ARTICLE #	SIZE
-08S-004	6" (16 cm)
-08S-005	8" (20 cm)
-08S-006	10" (25 cm)
-08S-007	11" (28 cm)

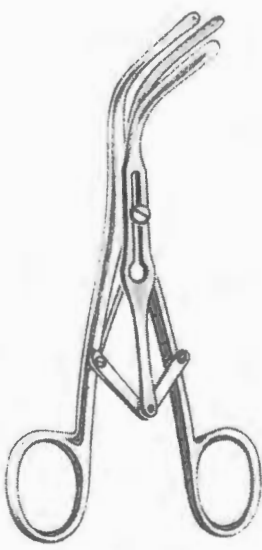

**-08S-008**  
Trocars  
Laborde Dilators  
5½" (14 cm)

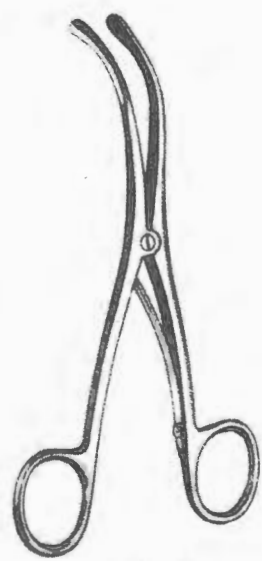

**-08S-009**  
Trocars Dilatory  
Trousseau  
5½" (14 cm)

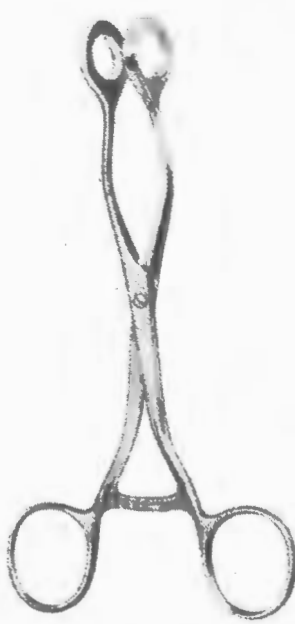

**-08S-010**  
Tongue Holding Forceps  
Collin  
6¼" (16 cm)

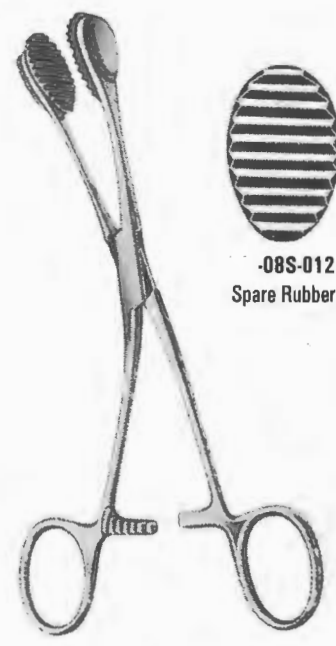

**-08S-011**  
Young Tongue Forceps  
6¾" (17 cm)



**-08S-012**  
Spare Rubber

# ORAL INSTRUMENTS

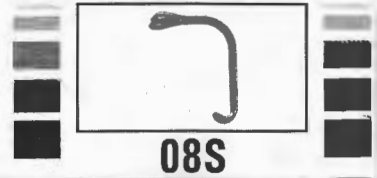

ORS

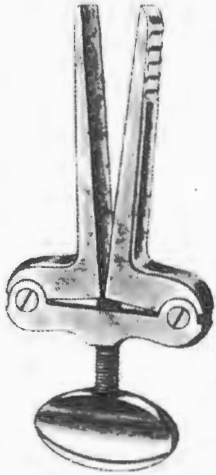

**-08S-013**  
Meister Mouth Gag  
5" (13 cm)

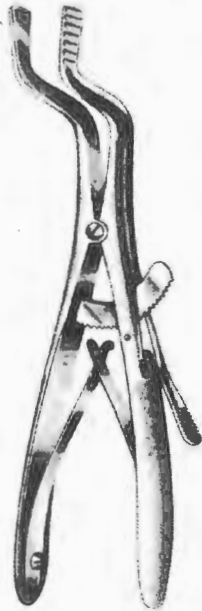

Roser-Konig Mouth Gag  
**ARTICLE #**    **SIZE**  
-08S-014    6¼" (16 cm)  
-08S-015    7½" (19 cm)

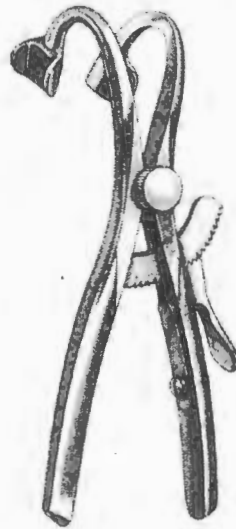

**-08S-016**  
Denhardt Mouth Gag  
6" (15 cm)

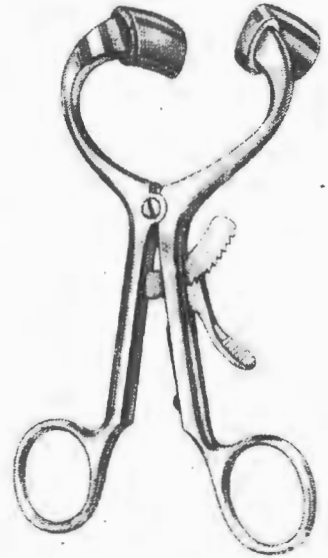

Molt Mouth Gag  
**ARTICLE #**    **SIZE**  
-08S-017    4" (10 cm)  
-08S-018    4½" (11,5 cm)  
-08S-019    5½" (14 cm)

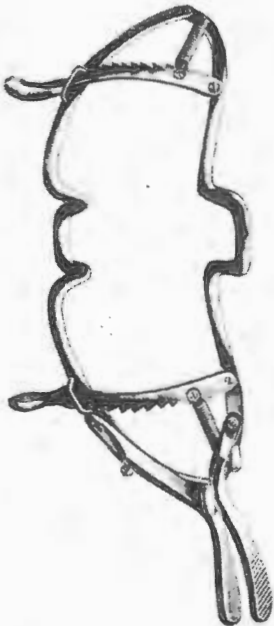

Whitehead Mouth Gag  
**ARTICLE #**    **SIZE**  
-08S-020    3½" (9 cm)  
-08S-021    4¼" (11 cm)  
-08S-022    5" (13 cm)  
-08S-023    6" (15 cm)

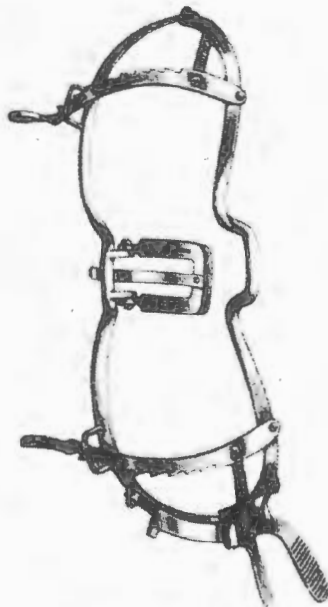

Whitehead Mouth Gag  
**ARTICLE #**    **SIZE**  
-08S-024    3½" (9 cm)  
-08S-025    4¼" (11 cm)  
-08S-026    5" (13 cm)  
-08S-027    6" (15 cm)

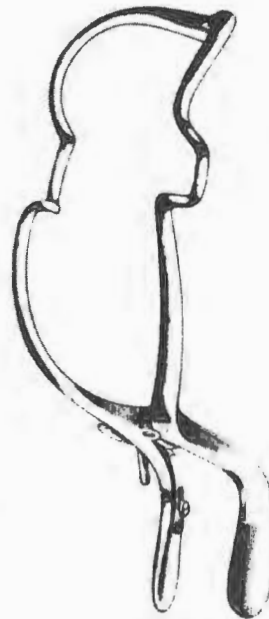

Jennings Mouth Gag  
**ARTICLE #**    **SIZE**  
-08S-028    3½" (9 cm)  
-08S-029    4¼" (11 cm)  
-08S-030    5" (13 cm)  
-08S-031    6" (15 cm)

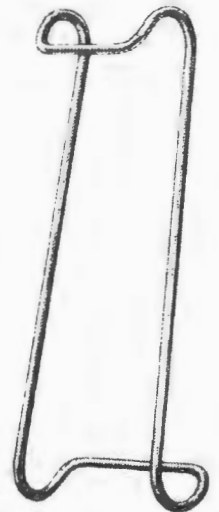

Coloumbia Lip Retractor Double End  
**ARTICLE #**    **SIZE**  
-08S-032    4¼" (12 cm)  
-08S-033    5½" (14 cm)  
-08S-034    6¼" (16 cm)

# ORAL INSTRUMENTS

08S

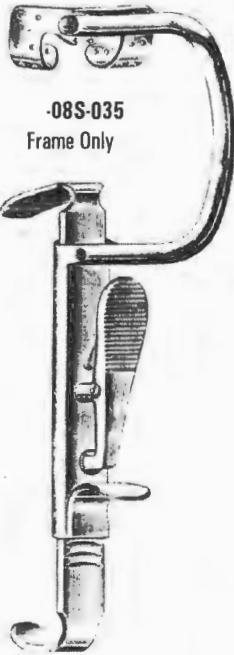

**-08S-035**  
Frame Only

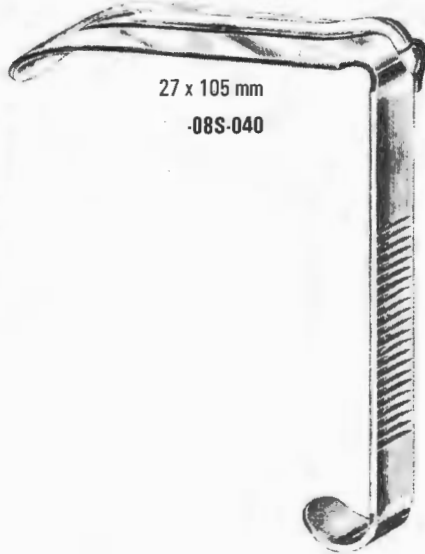

27 x 105 mm  
**-08S-040**

Davis-Boyle Mouth Gags

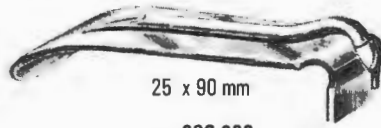

25 x 90 mm

**-08S-039**

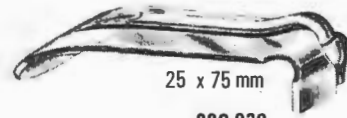

25 x 75 mm

**-08S-038**

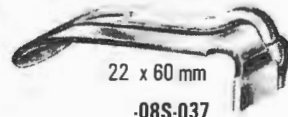

22 x 60 mm

**-08S-037**



20 x 15 mm

**-08S-036**

**-08S-041**  
Negus Mouth Gag  
(Complete Set)



**-08S-045**  
Frame Only

**-08S-046**  
McIvor Mouth Gage  
(Complete Set)



27 x 95 mm  
**-08S-044**

22 x 85 mm  
**-08S-043**

22 x 70 mm  
**-08S-042**



# E.N.T INSTRUMENTS

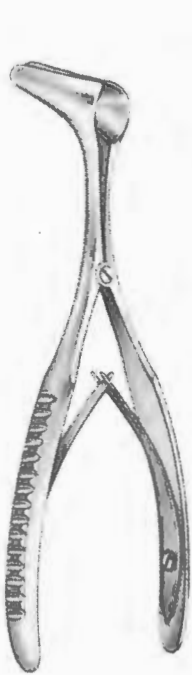

-09S-001

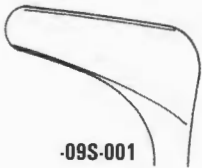

-09S-002

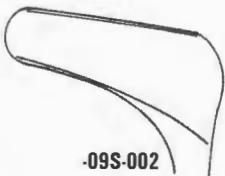

-09S-003

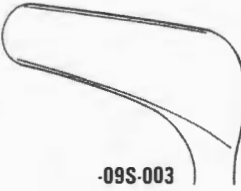

Hartmann-Halle Nasal Speculum  
5 1/2" (14 cm)



-09S-004

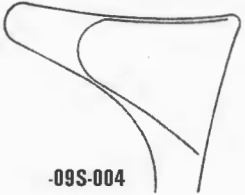

-09S-005

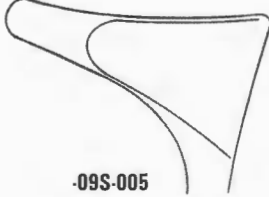

-09S-006

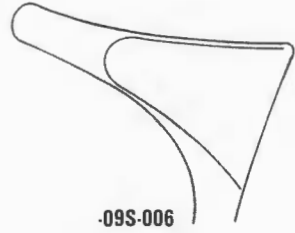

Hartmann Nasal Speculum  
5 1/2" (14 cm)



-09S-007



-09S-008



Tieck-Halle Nasal Speculum  
5 1/4" (13.5cm)

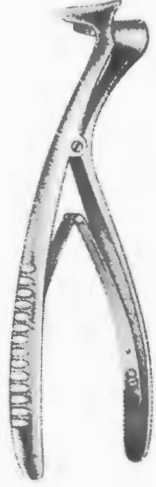

-09S-009



Beckmann Nasal Speculum  
5" (13 cm)



-09S-010

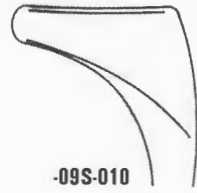

-09S-011

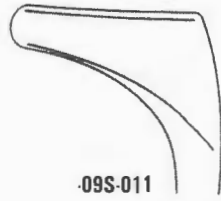

-09S-012

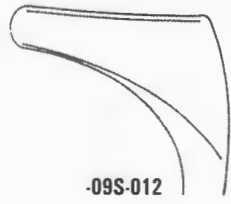

Beckmann Nasal Speculum  
5 1/2" (14 cm)



# E.N.T. INSTRUMENTS

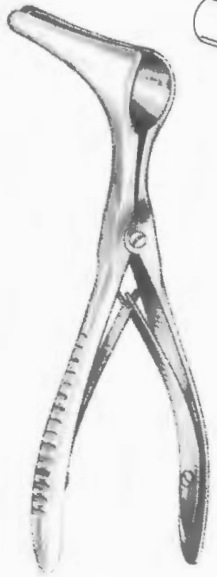

Killian Nasal Speculum  
5" (13 cm)

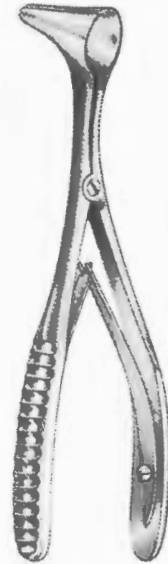
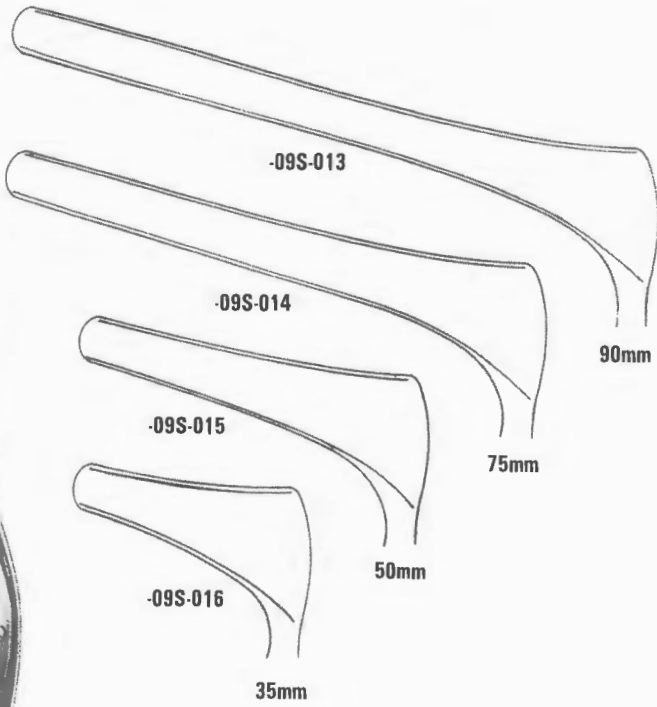

Vienna Nasal Speculum  
5½" (14 cm)

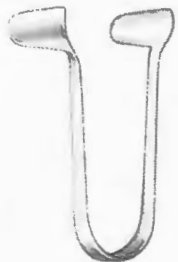
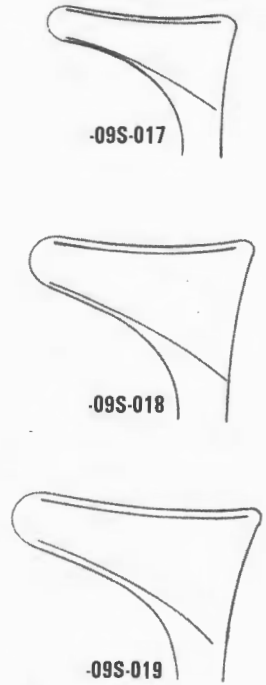

Thudichum  
(Goldsmith) Nasal Speculum  
2½" (6.5cm)



Voltolini (Duplay) Nasal Speculum

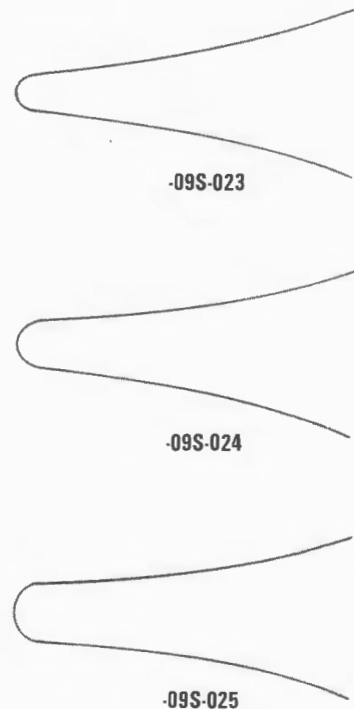

# E.N.T INSTRUMENTS



Politzer Ear Speculum



Toynbee Ear Speculum



Hartmann Ear Speculum



Gruber Ear Speculum

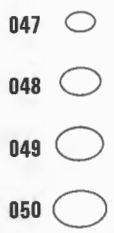

2.0	-09S-026	-09S-033	-09S-040	-09S-047
3.0	-09S-027	-09S-034	-09S-041	-09S-048
3.5	-09S-028	-09S-035	-09S-042	-09S-049
4.0	-09S-029	-09S-036	-09S-043	-09S-050
5.0	-09S-030	-09S-037	-09S-044	
6.5	-09S-031	-09S-038	-09S-045	
7.5	-09S-032	-09S-039	-09S-046	

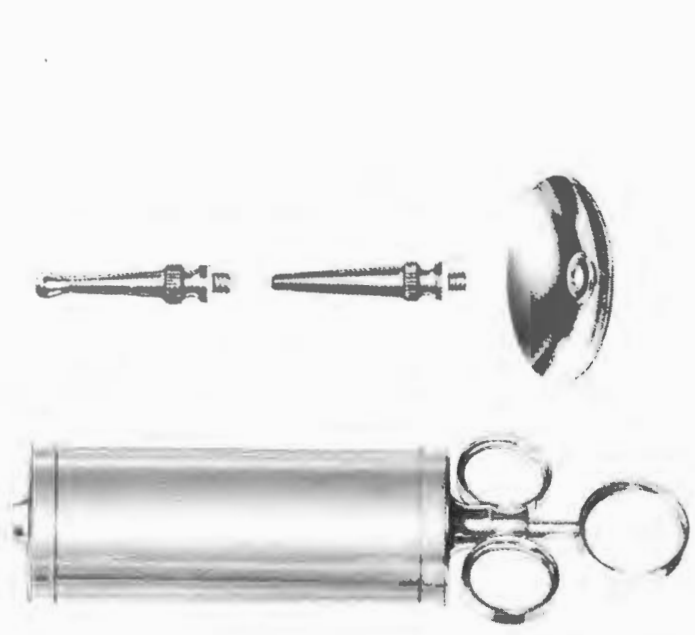

**-09S-051**  
Ear Syringe (Complete Set)



**-09S-052**  
Poltzer Air Bag (Complete Set with 4 Tips)

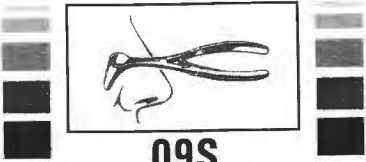

**O9S**

# E.N.T INSTRUMENTS

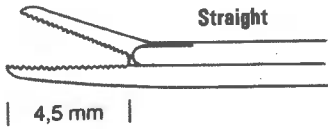

**Straight**

| 4,5 mm |



0,8 mm

**-09S-063**

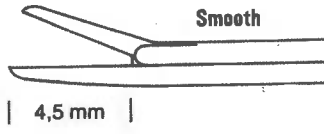

**Smooth**

| 4,5 mm |



0,8 mm

**-09S-062**

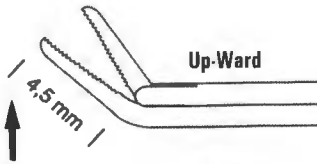

**Up-Ward**

| 4,5 mm |

**-09S-067**

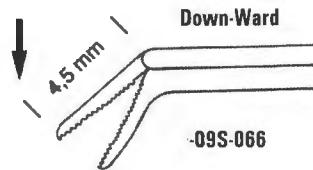

**Down-Ward**

| 4,5 mm |

**-09S-066**

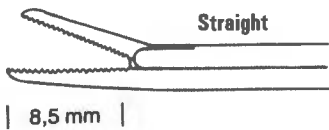

**Straight**

| 8,5 mm |



0,8 mm

**-09S-069**

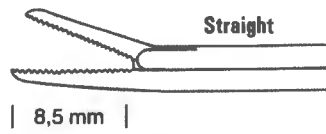

**Straight**

| 8,5 mm |



1,8 mm

**-09S-068**

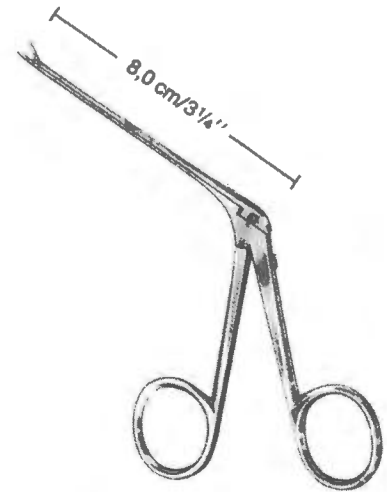

**Micro Ear Forceps**

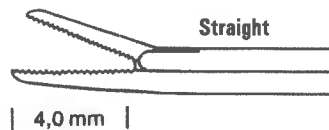

**Straight**

| 4,0 mm |



0,6 mm

**-09S-071**

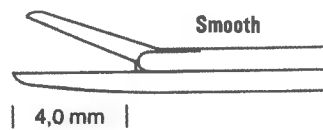

**Smooth**

| 4,0 mm |



0,6 mm

**-09S-070**

# E.N.T INSTRUMENTS



09S

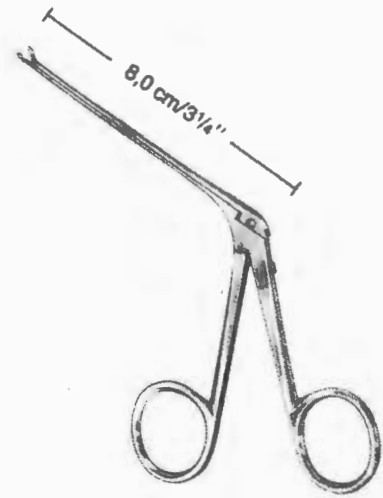
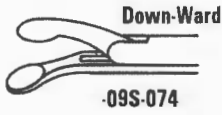
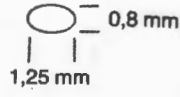

Micro Ear Forceps

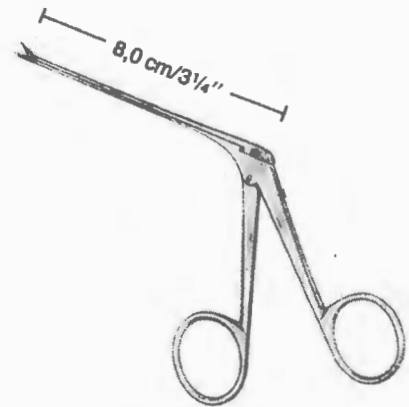
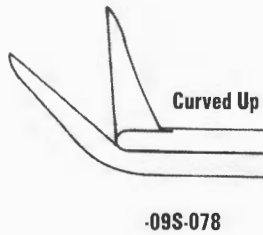
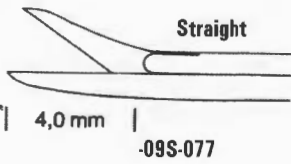

Bellucci Micro Ear Forceps

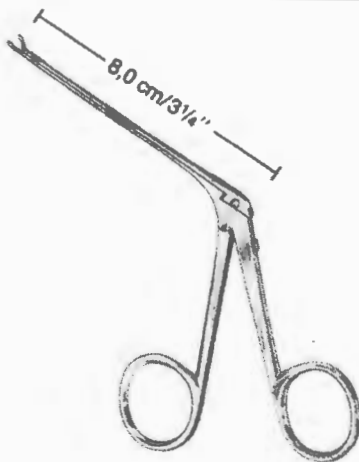

Crura-Nipper Micro Ear Forceps

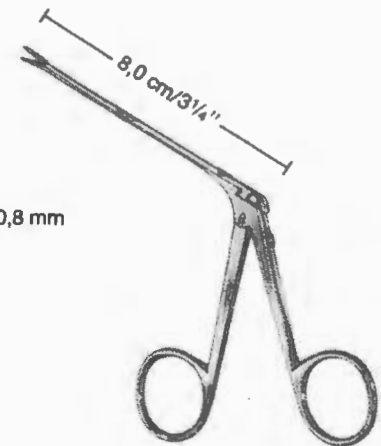
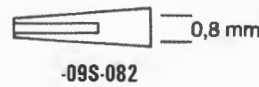
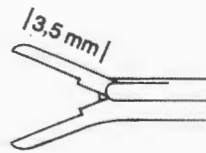

McGEE Ear Forceps



09S

# E.N.T INSTRUMENTS



**-09S-083**  
Hartmann-Wullstein



**-09S-084**  
Hartmann-Wullstein

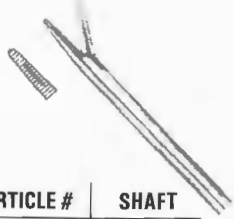
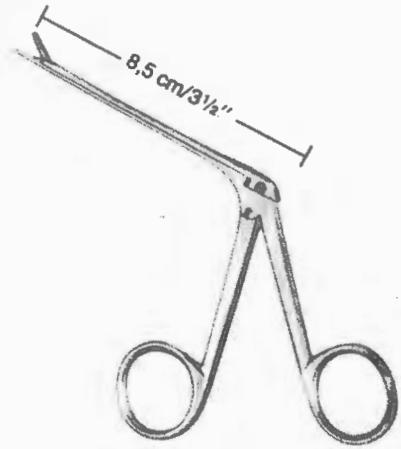

ARTICLE #	SHAFT
-09S-085	3 1/2" (8.5cm)
-09S-086	5 1/2" (14 cm)

Hartmann



ARTICLE #	SHAFT
-09S-088	3 1/2" (8.5cm)
-09S-089	5 1/2" (14 cm)

Hartmann



**-09S-090**  
Hartmann-Noyes



**-09S-091**  
Duckbill



**-09S-092**  
Weingartner

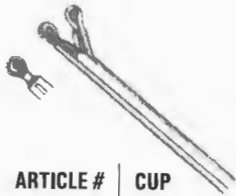

ARTICLE #	CUP
-09S-093	2.0mm
-09S-094	2.5mm
-09S-095	3.0mm

Hartmann



ARTICLE #	CUP
-09S-096	2.0mm
-09S-097	2.5mm
-09S-098	3.0mm

Hartmann

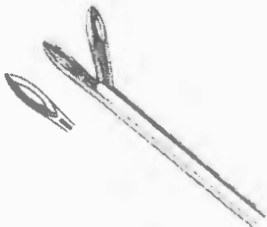

**-09S-099**  
Strompel



**-09S-100**  
Hartmann

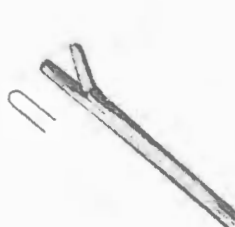

**-09S-101**  
Hartmann



**-09S-102**  
Hartmann-Hoffmann

# E.N.T INSTRUMENTS

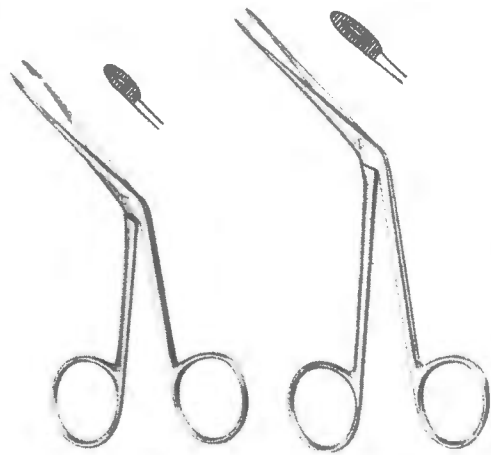
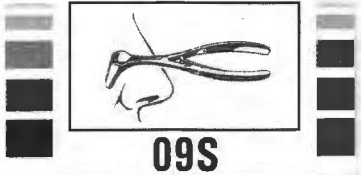

**-09S-103**  
Hartmann  
4 1/4" (12 cm)

**-09S-104**  
Hartmann  
5 1/2" (14 cm)

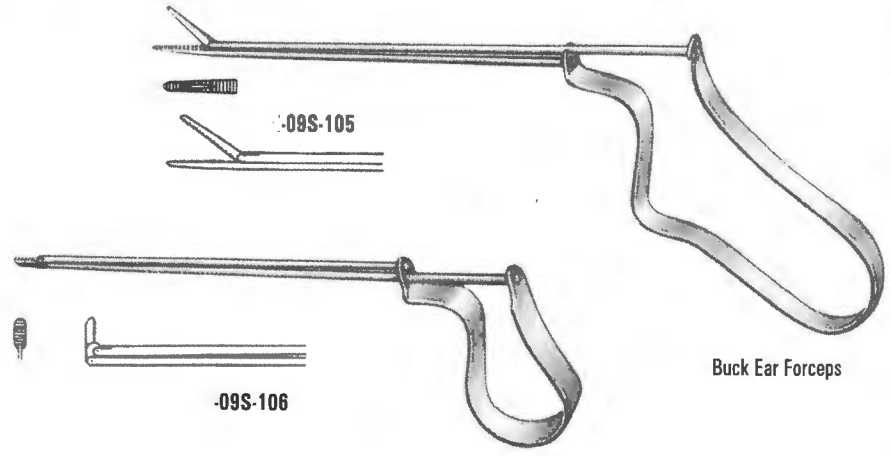

**-09S-105**

**-09S-106**

Buck Ear Forceps

Quire Ear Forceps



ARTICLE #	SIZE
-09S-107	6" (16 cm)
-09S-108	8" (20 cm)

Hartmann

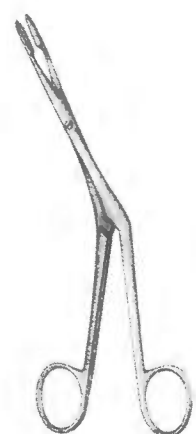

**-09S-109**  
Heymann-Knight Nasal Polypus Forceps  
7" (18 cm)

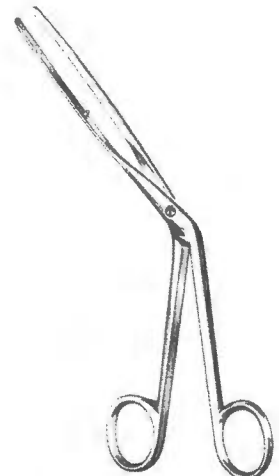

**-09S-110**  
Lubet-Barbon  
8" (20 cm)

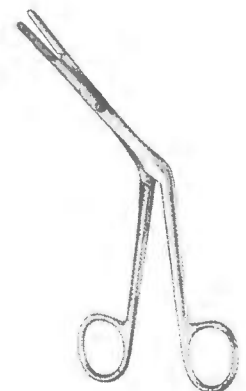

**-09S-111**  
Killian  
6 1/4" (17 cm)

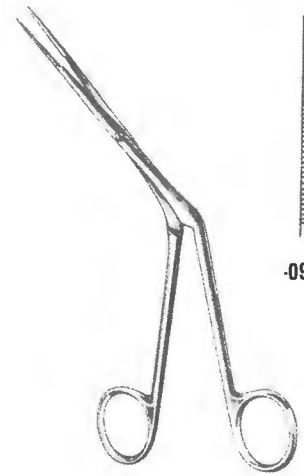

**-09S-112**  
Westmacott  
8" (20 cm)

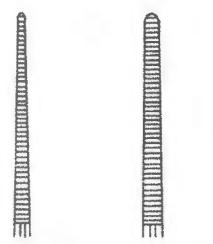

**-09S-112**      **-09S-113**

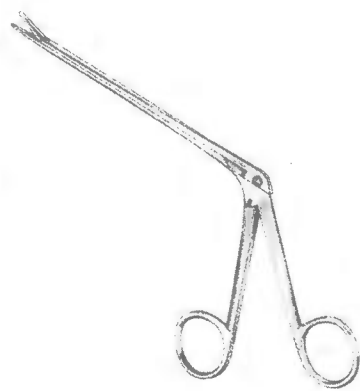

**-09S-114**  
Hartmann Nasal Polypus Forceps  
7 1/2" (19 cm)



# E.N.T INSTRUMENTS

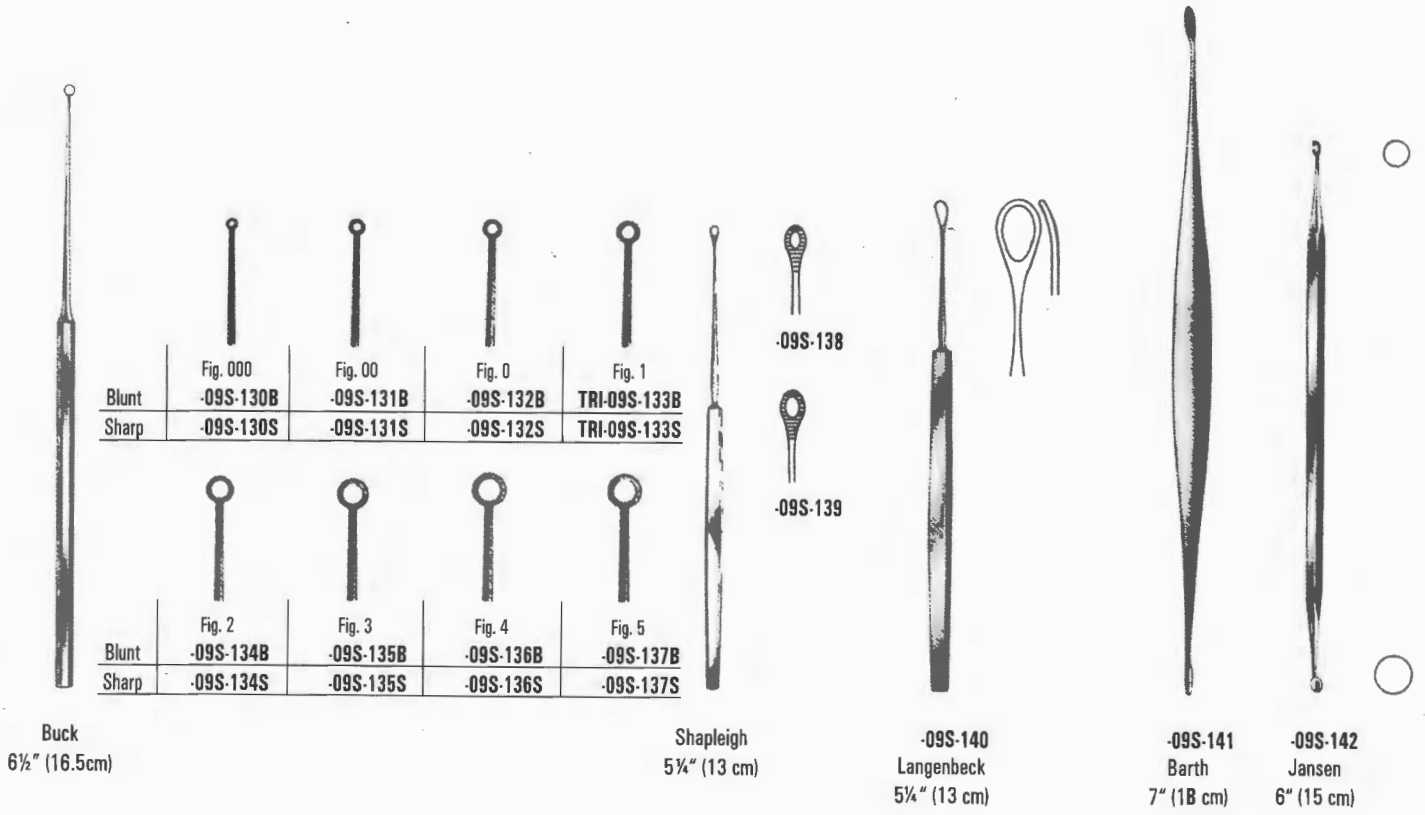
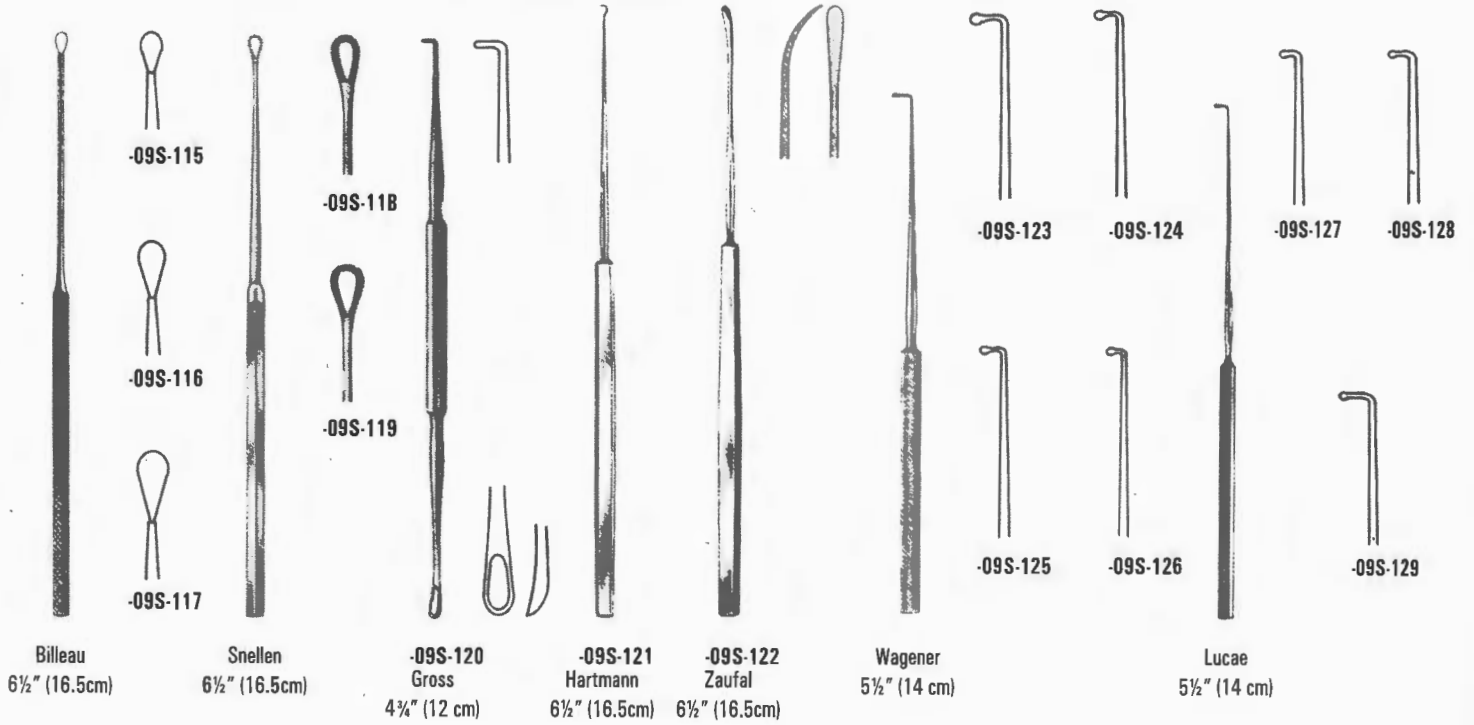



# E.N.T INSTRUMENTS

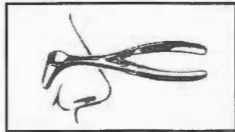

09S

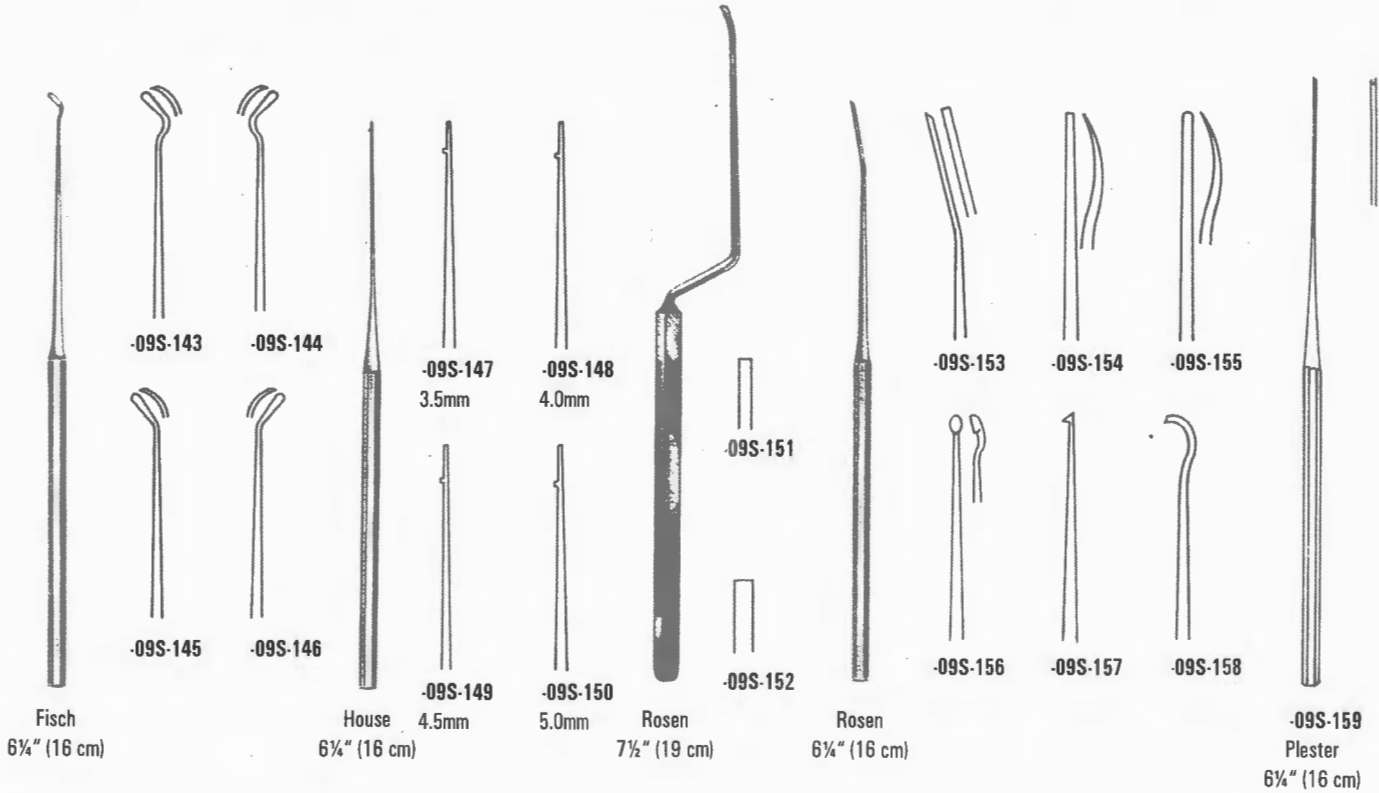



09S

# E.N.T INSTRUMENTS



-09S-175  
House

Foot Plate Hand Instruments  
6" (15 cm)



1.0mm



-09S-176  
House

Foot Plate Hand Instruments  
6" (15 cm)



1.5mm



-09S-179  
Shea

Foot Plate  
Hand Instruments  
6 1/4" (16 cm)



1.5 x 2.5mm



-09S-180  
Shea

Foot Plate Hand Instruments  
6 1/4" (16 cm)



1.5 x 2.5mm



-09S-181  
Buckingham

Foot Plate Hand Instruments  
8 1/4" (16 cm)



-09S-183  
Buckingham



-09S-185  
Buckingham



-09S-182  
Larkin



-09S-184  
Larkin



-09S-186  
Larkin



Lempert Curettes  
8 1/4" (21 cm)

Fig.0

-09S-187

Fig.00

-09S-188

Fig.000

-09S-189

Fig.0000

-09S-190

Fig.00000

-09S-191



Wullstein Curettes  
6" (16 cm)



-09S-192  
2.2mm



-09S-193  
3.2mm



-09S-194  
Lempert Curettes  
6 1/4" (16 cm)



3mm



-09S-195  
Shambaugh-Derlacki  
Curettes  
6 1/4" (16 cm)



Lempert Curettes  
6" (17 cm)



-09S-196  
2mm



-09S-198  
4mm



-09S-197  
3mm



-09S-199  
5mm

# E.N.T INSTRUMENTS



Straight



Curved

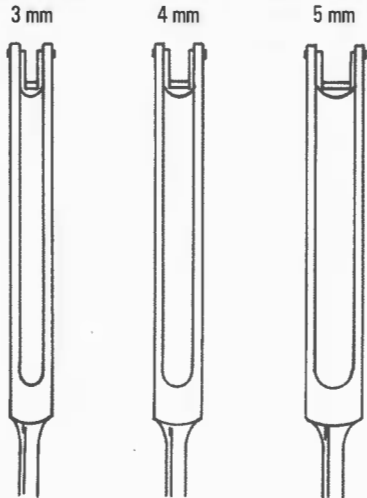

Straight	-09S-200	-09S-201	-09S-202
Curved	-09S-203	-09S-204	-09S-205

**Ballenger Spetum Knives**  
8" (20 cm)



**-09S-206**  
Joseph-Masing  
8 1/4" (22 cm)

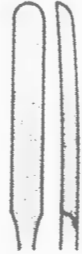

**-09S-207**  
Halle  
Periosteal Elevators  
6 1/2" (16.5 cm)

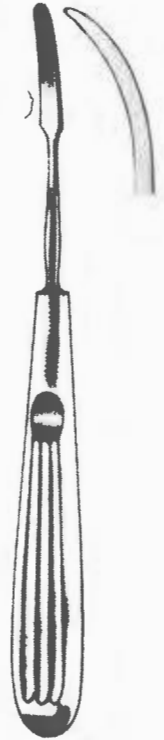

**-09S-208**  
Joseph  
Periosteal Elevators  
6 1/2" (16.5 cm)

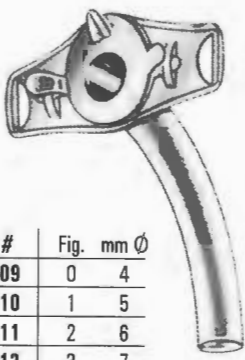
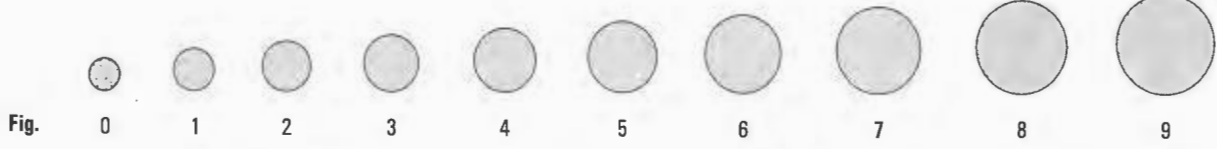

Luer

ARTICLE #	Fig.	mm Ø
-09S-209	0	4
-09S-210	1	5
-09S-211	2	6
-09S-212	3	7
-09S-213	4	8
-09S-214	5	9
-09S-215	6	10
-09S-216	7	11
-09S-217	8	12
-09S-218	9	13

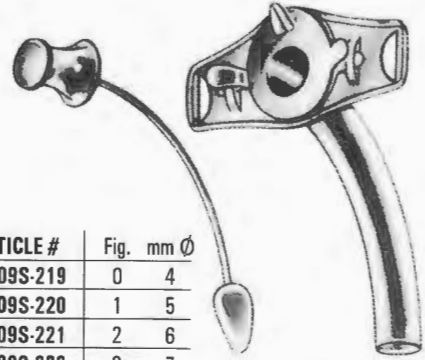

Chevalier-Jackson

ARTICLE #	Fig.	mm Ø
-09S-219	0	4
-09S-220	1	5
-09S-221	2	6
-09S-222	3	7
-09S-223	4	8
-09S-224	5	9
-09S-225	6	10
-09S-226	7	11
-09S-227	8	12
-09S-228	9	13



# E.N.T. INSTRUMENTS

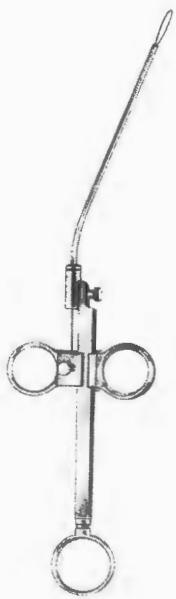

- **-09S-239**  
Krause Nasal Snare  
6 1/4" (16 cm)



- **-09S-240**  
Krause-Voss Nasal Snare  
6 1/4" (16 cm)

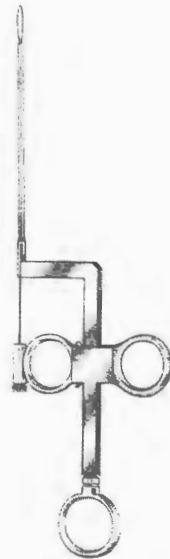

- **-09S-241**  
Lange-Wilde Nasal Snare  
6 1/4" (16 cm)

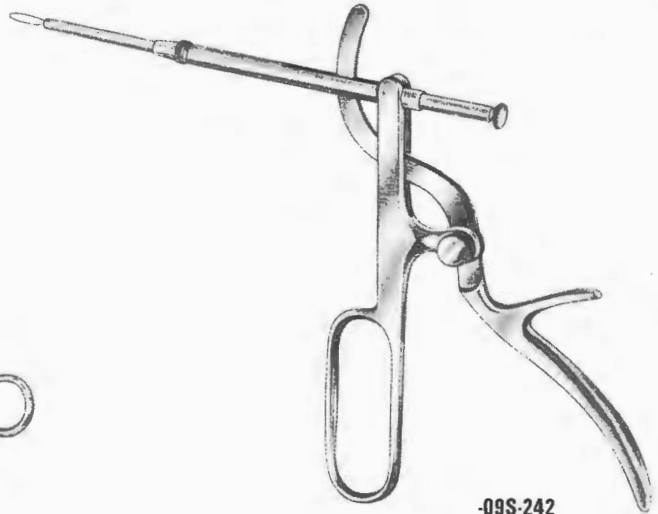

- **-09S-242**  
Tonsil Snare



Hartmann  
Otolaryngology Instruments  
5 1/2" (14 cm)

- - **-09S-243**
- - **-09S-244**
- - **-09S-245**
- - **-09S-246**
- - **-09S-247**
- - **-09S-248**



- **-09S-249 - TRI-09S-255**  
Frazier Suction Tubes  
7 1/2" (19 cm)

ARTICLE #	Fr.
-09S-249	6
-09S-250	7
-09S-251	8
-09S-252	9
-09S-253	10
-09S-254	11
-09S-255	12



- **-09S-256 - TRI-09S-258**  
Baron Suction Tubes

ARTICLE #	Fr.
-09S-256	3
-09S-257	5
-09S-258	7

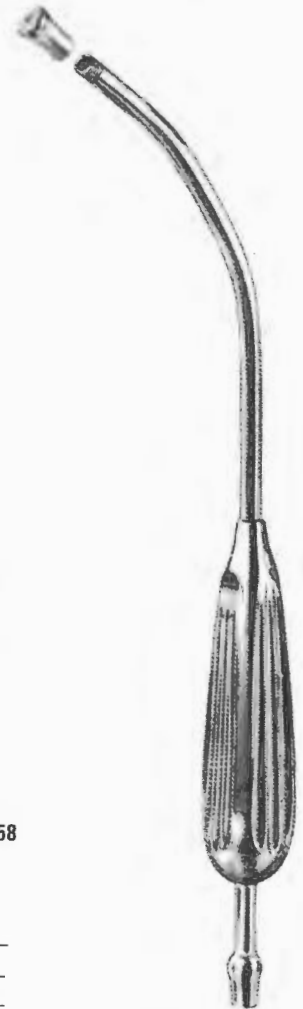

- **-09S-259**  
Suction Tubes  
11 1/4" (30 cm)

# E.N.T INSTRUMENTS



Lewis  
7" (18 cm)

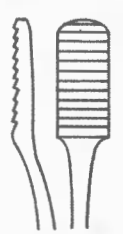

-09S-260

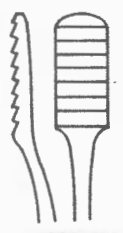

-09S-261



-09S-262  
Cottle  
8 1/4" (21 cm)

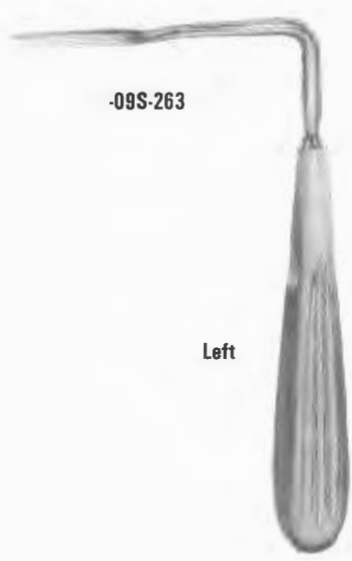

-09S-263

Left

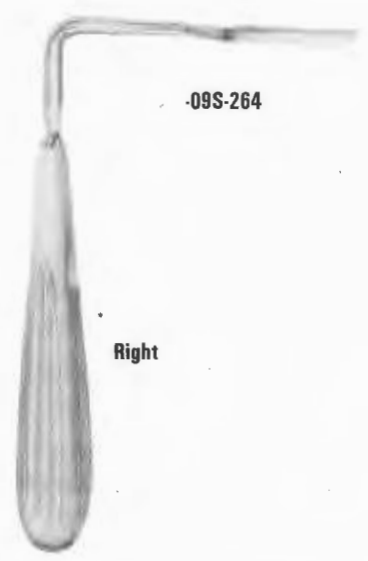

-09S-264

Right

Joseph  
6 1/4" (17 cm)



-09S-265  
Maltz  
7" (18 cm)

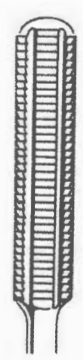

Joseph  
7 1/2" (19 cm)



-09S-266



-09S-267



-09S-268

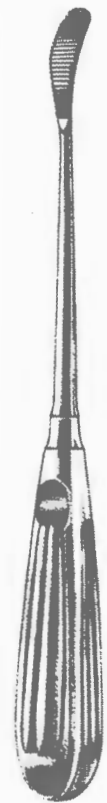

Aufrecht  
8 1/4" (21 cm)



-09S-269



-09S-270

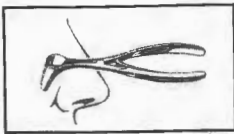

09S

# E.N.T INSTRUMENTS



**-09S-271- TRI-09S-276**  
Hartmann  
Tuning Fork

-09S-271	C 128
-09S-272	C 256
-09S-273	C 512
-09S-274	C 1024
-09S-275	C 2048
-09S-276	C 4096



**-09S-277- TRI-09S-282**  
Lucae  
Tuning Fork

-09S-277	C 128
-09S-278	C 256
-09S-279	C 512
-09S-280	C 1024
-09S-281	C 2048
-09S-282	C 4096

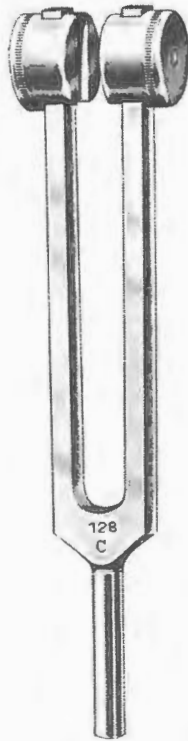

**-09S-283- TRI-09S-285**  
Tuning Fork

-09S-283	C 64
-09S-284	C 128
-09S-285	C 256



**-09S-286**  
Koenig A-109  
Tuning Fork

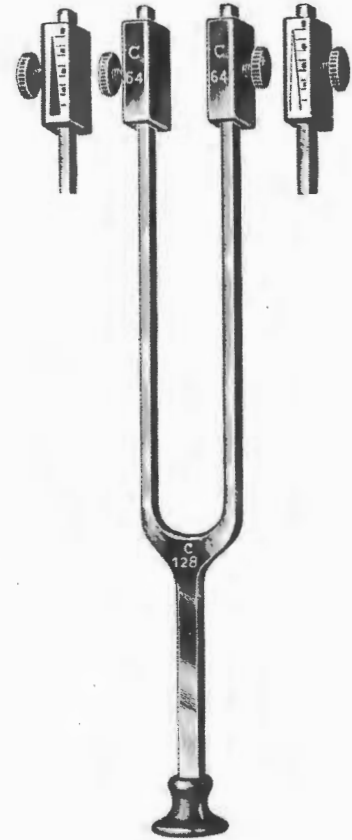

**-09S-287**  
Rydell-Seiffer  
C64/C128  
Tuning Fork

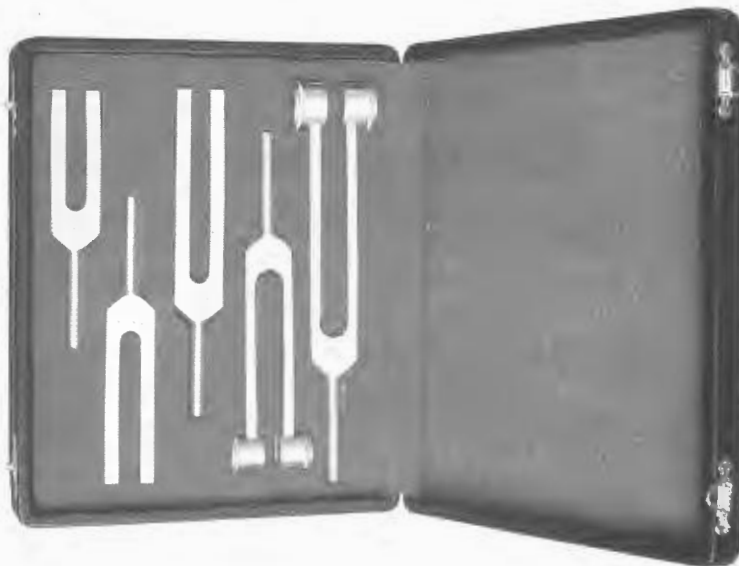

**-09S-288**  
Set of Tuning Forks  
C 128  
C 256  
C 512  
C 1024  
C 2048

# NEURO SURGERY INSTRUMENTS



10S

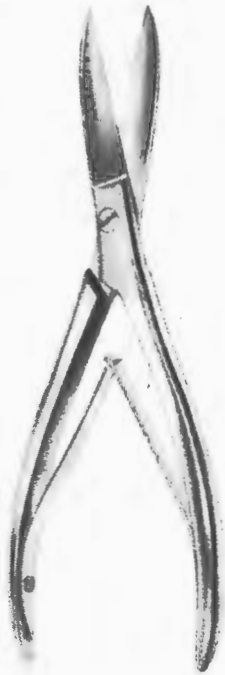

**-10S-001**  
Bone & Rib Shears  
9" (23 cm)



**-10S-002**  
Bone & Rib Shears  
8¾" (22 cm)



**-10S-003**  
Gluck  
Bone & Rib Shears  
8¾" (22 cm)

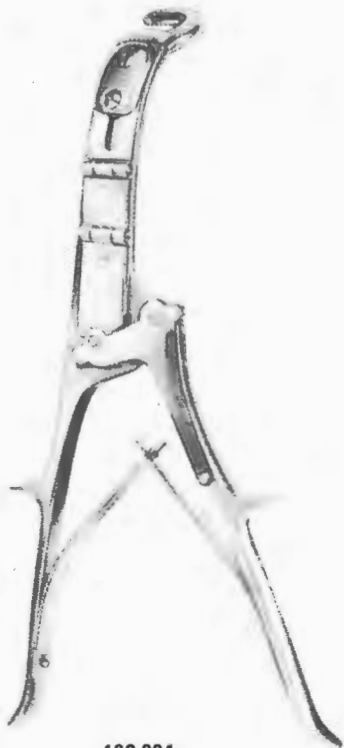

**-10S-004**  
Brunner Sternum Scissors  
12½" (32 cm)

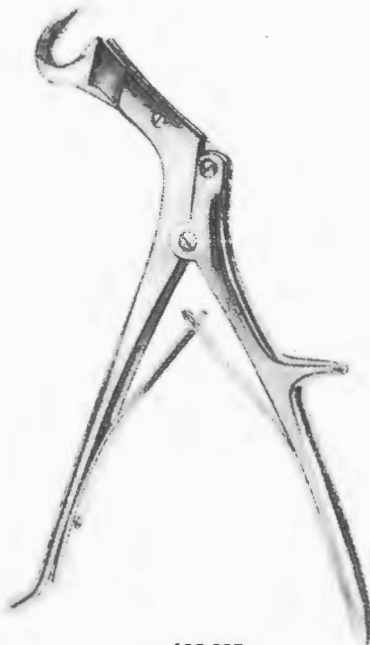

**-10S-005**  
Giertz-Stille  
Sternum Scissors  
10½" (27 cm)

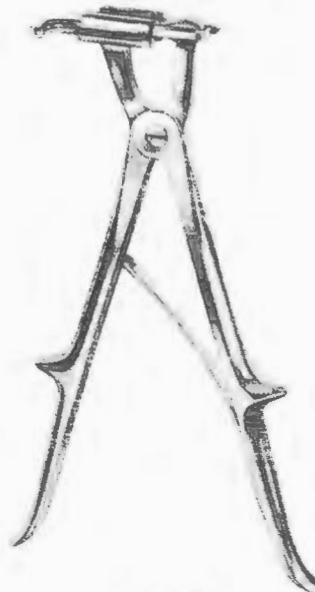

**-10S-006**  
Sauerb-Ruch  
Sternum Scissors  
10¼" (26 cm)

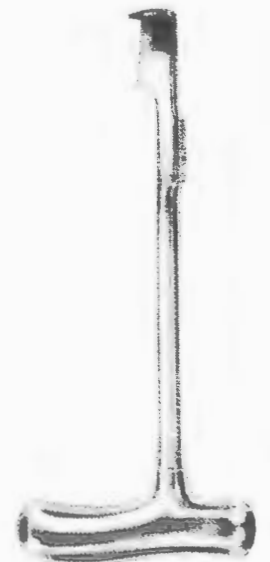

**-10S-007**  
Lebsche  
Sternum Scissors  
9¾" (25 cm)



# NEURO SURGERY INSTRUMENTS

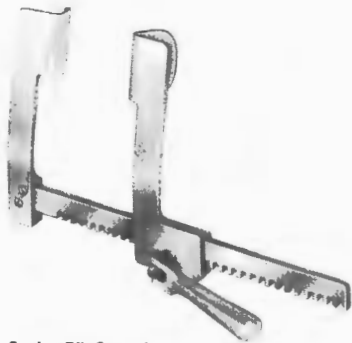

Cooley Rib Spreader

Art.No	A	B	C	D
-10S-008	20mm	45mm	140mm	110mm
-10S-009	30mm	50mm	180mm	145mm
-10S-010	30mm	50mm	200mm	145mm

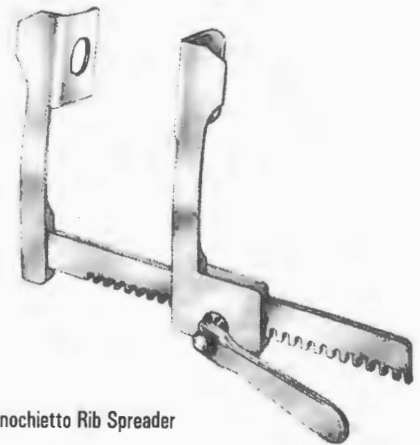
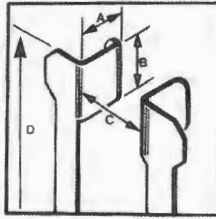

Finochietto Rib Spreader

Art.No	A	B	C	D
-10S-011	30mm	45mm	140mm	110mm
-10S-012	42mm	62mm	175mm	140mm
-10S-013	75mm	65mm	200mm	140mm



Cooley Rib Spreader

Art.No	A	B	C	D
-10S-014	35mm	100mm	180mm	180mm
-10S-015	35mm	115mm	230mm	205mm



Burford-Finochitto Rib Spreader

Art.No	A	B	C	D
-10S-016	45mm	62mm	180mm	200mm
-10S-017	45mm	62mm	250mm	200mm
-10S-018	45mm	62mm	300mm	200mm

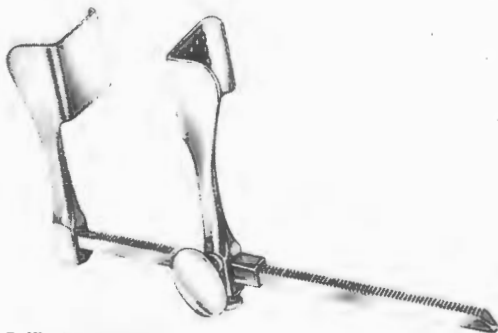

Tuffier Rib Spreader

Art.No	A	B	C	D
-10S-019	42mm	45mm	170mm	110mm

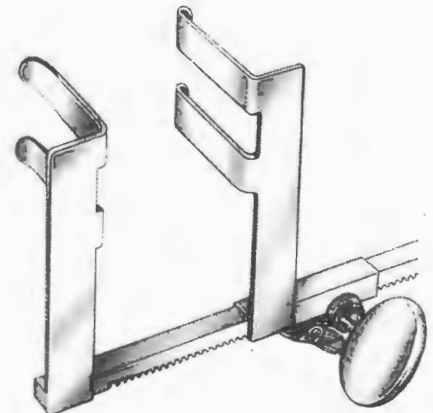

Mini Thoracotomy Rib Spreader

Art.No	A	B	C	D
-10S-020	38mm	12mm	70mm	90mm



# NEURO SURGERY INSTRUMENTS



10S



French Laminectomy Spreader

Art.No	A	B	C	D
-10S-021	38mm	32mm	130mm	125mm



-10S-022  
Bailey-Baby Rib Contractors  
6" (15 cm)

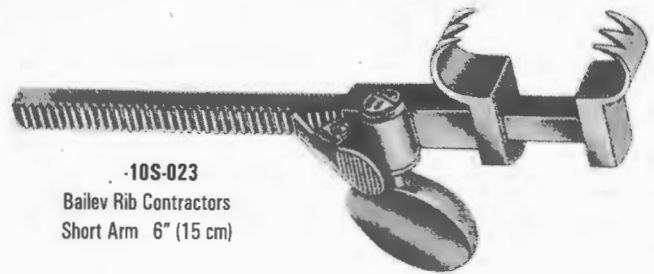

-10S-023  
Bailey Rib Contractors  
Short Arm 6" (15 cm)



-10S-024  
Bailey-Gibbon Rib Contractors  
6" (15 cm) Long Arm



-10S-025  
Casper Retractor for Spine



-10S-026 | 50 x 25 mm  
-10S-027 | 60 x 25 mm



-10S-033 | 40 x 23 mm  
-10S-034 | 45 x 23 mm  
-10S-035 | 50 x 23 mm  
-10S-036 | 55 x 23 mm  
-10S-037 | 60 x 23 mm



-10S-028 | 40 x 23 mm  
-10S-029 | 45 x 23 mm  
-10S-030 | 50 x 23 mm  
-10S-031 | 55 x 23 mm  
-10S-032 | 60 x 23 mm



-10S-038 | 45 x 23 mm  
-10S-039 | 50 x 23 mm  
-10S-040 | 55 x 23 mm  
-10S-041 | 60 x 23 mm  
-10S-042 | 65 x 23 mm



10S

# NEURO SURGERY INSTRUMENTS

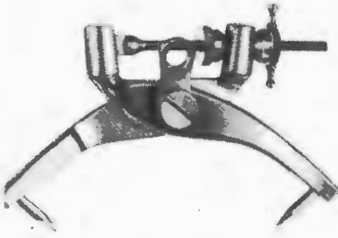

**-10S-043**  
Crutchfield Traction  
Cervical Tongs Small

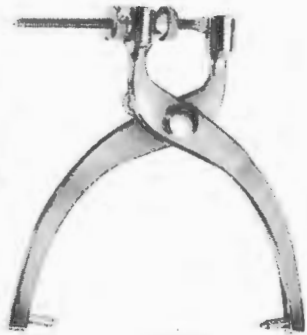

**-10S-044**  
Crutchfield Traction  
Tongs Medium



**-10S-045**  
3.5mmØ



**-10S-046**  
5mmØ

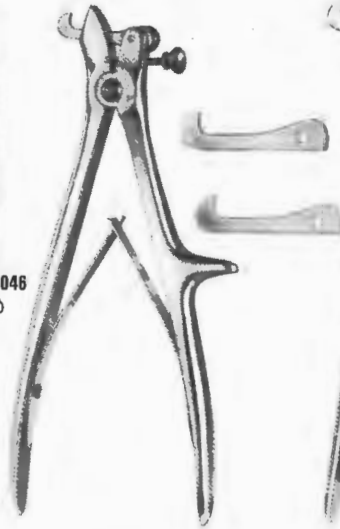

**-10S-047**  
Dahlgren Instruments  
8" (20 cm)



**-10S-048**  
De Vilbiss Instruments  
8 1/2" (21 cm)



**-10S-049**  
Large Lamina Spreader  
10 3/4" (27 cm)

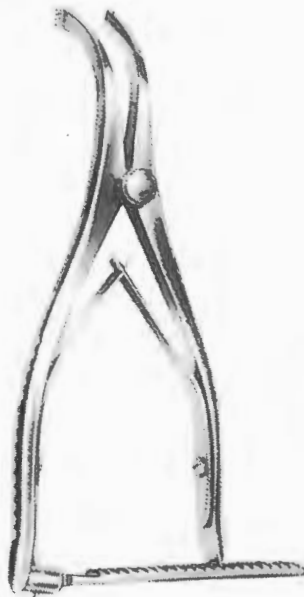

**-10S-050**  
Large Lamina Spreader  
6 1/2" (16 cm)



**-10S-051**  
Cloward Lamina Spreader  
6 1/2" (16 cm)

# NEURO SURGERY INSTRUMENTS



10S

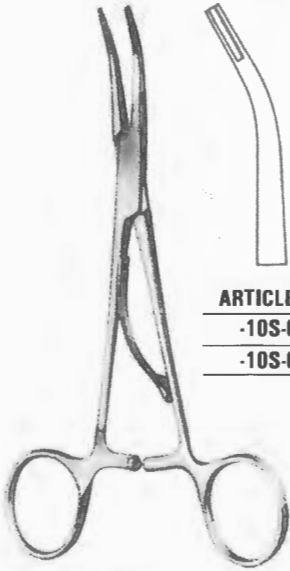

ARTICLE #	SIZE
-10S-052	6" (15 cm)
-10S-053	7½" (19 cm)

McKenzie  
Clip Applying Forceps  
Curved



ARTICLE #	SIZE
-10S-054	6" (15 cm)
-10S-055	7½" (19 cm)

McKenzie  
Clip Applying Forceps  
Straight

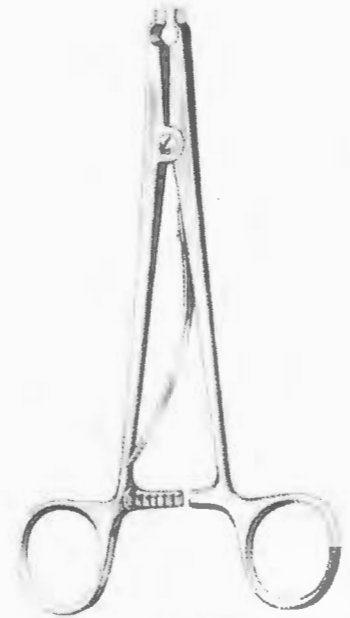

-10S-056  
Raney  
Hemostatic Clip Applying Forceps  
6" (15 cm)

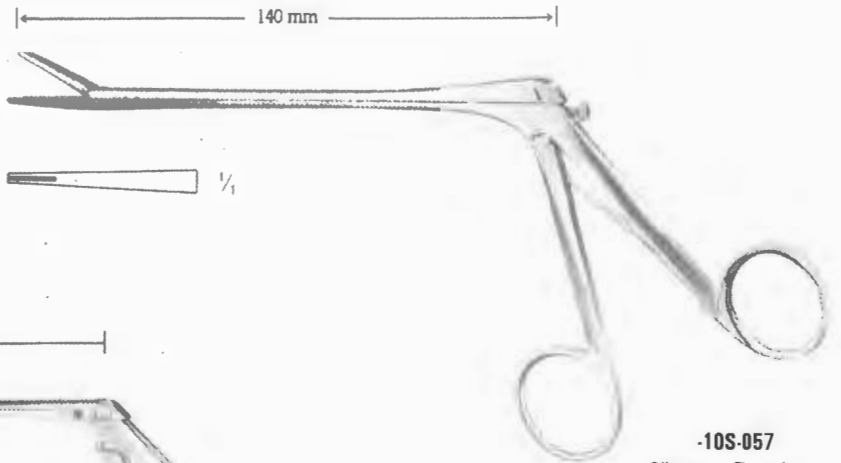

-10S-057  
Oliveirona-Toennis  
(Scoville) 5.5" (14 cm)

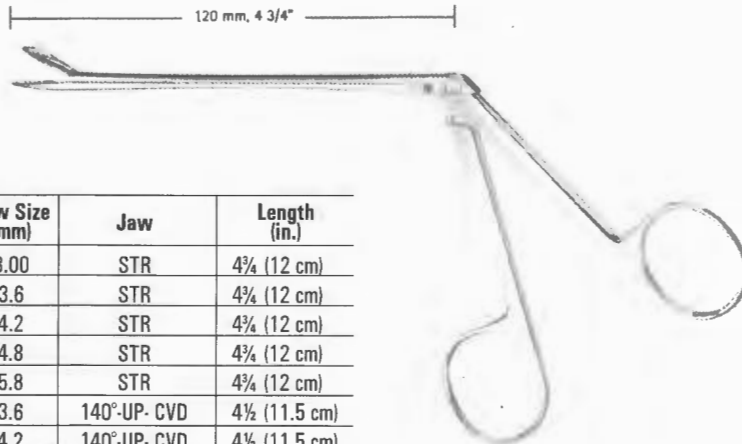

-10S-058 to TRI-10S-065  
Weil-Blakesley Rongeur

Art No.	Jaw Size (mm)	Jaw	Length (in.)
-10S-058	3.00	STR	4¼ (12 cm)
-10S-059	3.6	STR	4¼ (12 cm)
-10S-060	4.2	STR	4¼ (12 cm)
-10S-061	4.8	STR	4¼ (12 cm)
-10S-062	5.8	STR	4¼ (12 cm)
-10S-063	3.6	140°-UP- CVD	4½ (11.5 cm)
-10S-064	4.2	140°-UP- CVD	4½ (11.5 cm)
-10S-065	4.8	140°-UP- CVD	4½ (11.5 cm)



10S

# NEURO SURGERY INSTRUMENTS

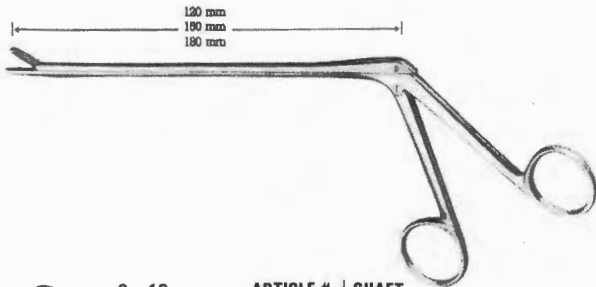

2 x 10 mm	ARTICLE #	SHAFT
	-10S-084	120 mm
	-10S-085	150 mm
	-10S-086	180 mm

3 x 10 mm	ARTICLE #	SHAFT
	-10S-087	120 mm
	-10S-088	150 mm
	-10S-089	180 mm

4 x 10 mm	ARTICLE #	SHAFT
	-10S-090	120 mm
	-10S-091	150 mm
	-10S-092	180 mm

ARTICLE #	SHAFT	2 x 10 mm / 45°
-10S-093	120 mm	
-10S-094	150 mm	
-10S-095	180 mm	

ARTICLE #	SHAFT	3 x 10 mm / 45°
-10S-096	120 mm	
-10S-097	150 mm	
-10S-098	180 mm	

ARTICLE #	SHAFT	4 x 10 mm / 45°
-10S-099	120 mm	
-10S-100	150 mm	
-10S-101	180 mm	

2 x 10 mm / 45°	ARTICLE #	SHAFT
	-10S-102	120 mm
	-10S-103	150 mm
	-10S-104	180 mm

3 x 10 mm / 45°	ARTICLE #	SHAFT
	-10S-105	120 mm
	-10S-106	150 mm
	-10S-107	180 mm

4 x 10 mm / 45°	ARTICLE #	SHAFT
	-10S-108	120 mm
	-10S-109	150 mm
	-10S-110	180 mm

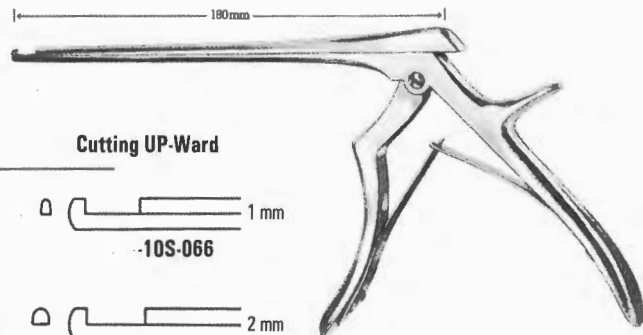

Ferris-Smith-Kerrison

### Cutting UP-Ward

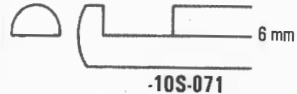
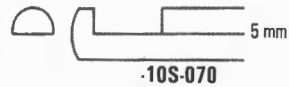
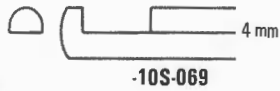
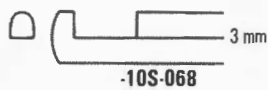
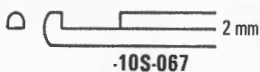
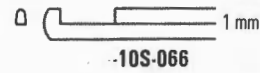

### Cutting 40° Angle

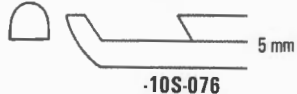
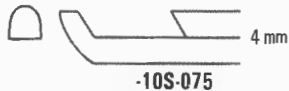
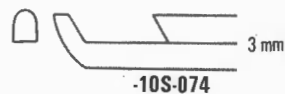
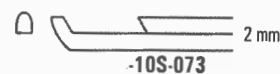

### Cutting Down-Ward

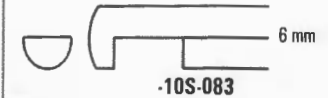
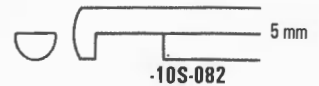
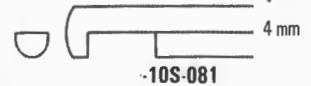
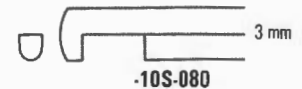
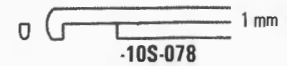

# BONE SURGERY INSTRUMENTS

11S



-11S-001  
Bone Hand Drills  
5½" (14 cm)



-11S-002  
Bone Hand Drills  
5½" (14 cm)

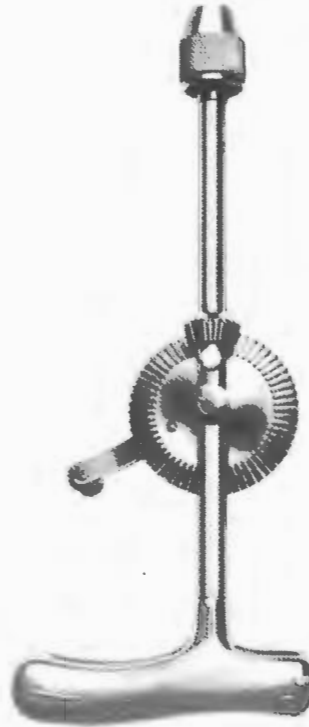

-11S-003  
Moore Hand Drills



-11S-004  
9 cm  
Ø 3,2mm

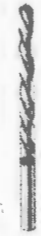

-11S-005  
7 cm  
Ø 3,2mm

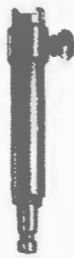

-11S-006  
Hudson Bone Hand Drills  
10" (27 cm)



-11S-007  
9 mm Ø



-11S-008  
14 mm Ø



-11S-009  
16 mm Ø



-11S-010  
22 mm Ø



-11S-011  
Cushing  
14 mm Ø



-11S-012  
2 mm Ø



-11S-013  
McKenzie  
13 mm Ø



-11S-014  
Errico  
16 mm Ø

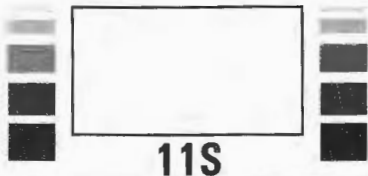

# BONE SURGERY INSTRUMENTS

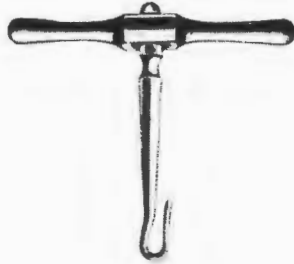

**-11S-015**  
Gigli Saw Handle

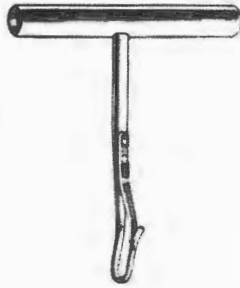

**-11S-016**  
Gigli Strully Saw Handle

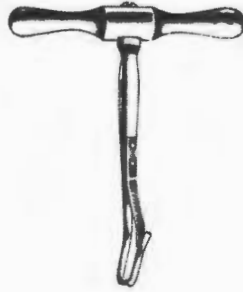

**-11S-017**  
Gigli Strully Saw Handle

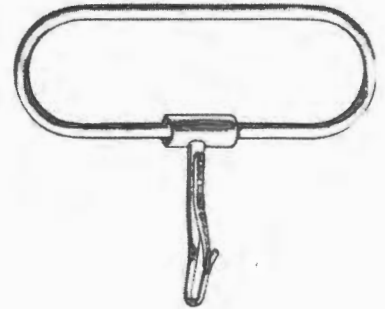

**-11S-018**  
Gigli Strully Saw Handle

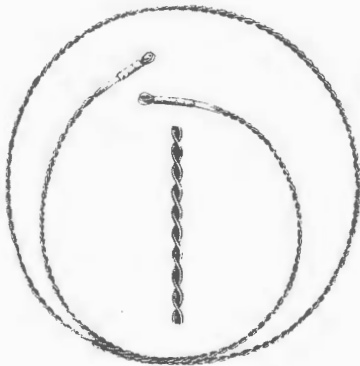

Gigli Saw Wire

ARTICLE #	SIZE
-11S-019 A	12" (30 cm)
-11S-019 B	20" (51 cm)
-11S-019 C	30" (76 cm)



Saw Blade  
**-11S-020**  
15mm



**-11S-021**  
Charriere Resection Saw  
14" (35 cm)



**-11S-022**  
Langenbeck Saw  
9" (23 cm)



**-11S-023**  
Charriere Saw  
10½" (27 cm)



**-11S-024**  
Satterlee Saw  
13¼" (31 cm)

# BONE SURGERY INSTRUMENTS

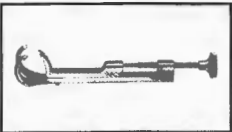

**11S**



**Schede Bone Curettes**  
6½" (16 cm)

- Fig. 000  
-11S-025
- Fig. 00  
-11S-026
- Fig. 0  
-11S-027
- Fig. 1  
-11S-028
- Fig. 2  
-11S-029
- Fig. 3  
-11S-030
- Fig. 4  
-11S-031



**Volkmann Bone Curettes**  
6½" (16 cm)

- Fig. 0000  
-11S-032
- Fig. 000  
-11S-033
- Fig. 00  
-11S-034
- Fig. 0  
-11S-035
- Fig. 1  
-11S-036
- Fig. 2  
-11S-037
- Fig. 3  
-11S-038
- Fig. 4  
-11S-039
- Fig. 5  
-11S-040
- Fig. 6  
-11S-041



**Bruns Bone Curettes**  
6½" (16 cm)

- Fig. 0000  
-11S-042
- Fig. 000  
-11S-043
- Fig. 00  
-11S-044
- Fig. 0  
-11S-045
- Fig. 1  
-11S-046
- Fig. 2  
-11S-047
- Fig. 3  
-11S-048
- Fig. 4  
-11S-049
- Fig. 5  
-11S-050
- Fig. 6  
-11S-051



**Spratt Bone Curettes**  
6½" (16 cm)

- Fig. 0000  
-11S-052
- Fig. 000  
-11S-053
- Fig. 00  
-11S-054
- Fig. 0  
-11S-055
- Fig. 1  
-11S-056
- Fig. 2  
-11S-057
- Fig. 3  
-11S-058
- Fig. 4  
-11S-059
- Fig. 5  
-11S-060

# BONE SURGERY INSTRUMENTS

11S

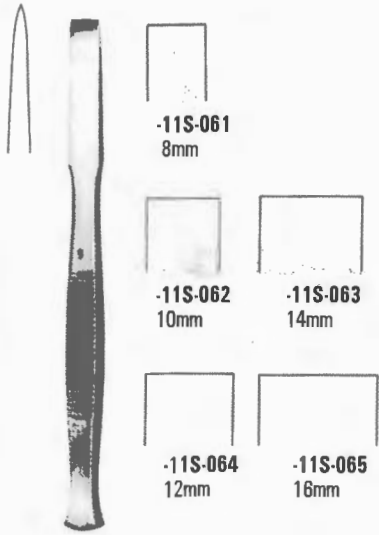

Bone Chisels  
5 1/4" (13,5cm)

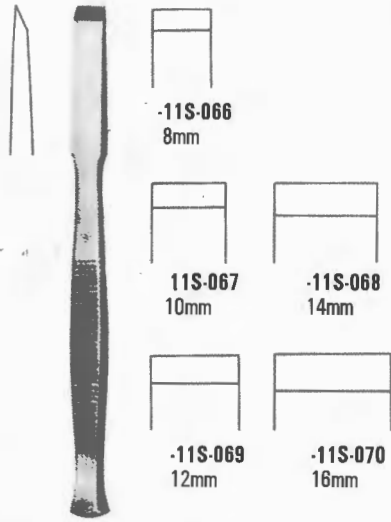

Bone Chisels  
5 1/4" (13,5cm)

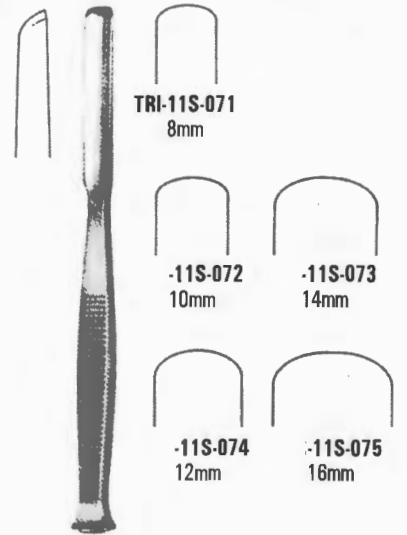

Bone Gouge  
5 1/4" (13,5cm)

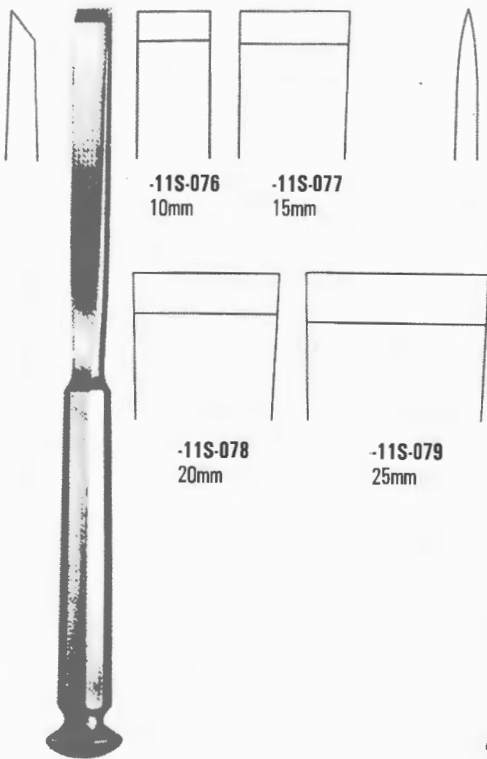

Stille Bone Chisels  
8" (20 cm)

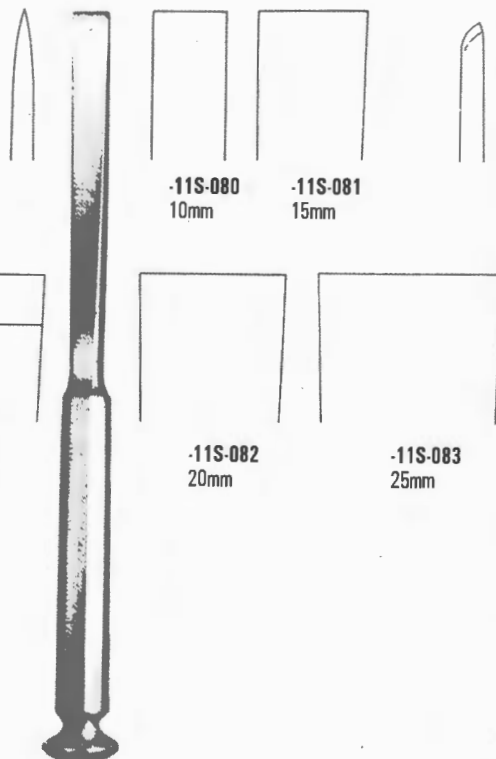

Stille Bone Chisels  
8" (20 cm)

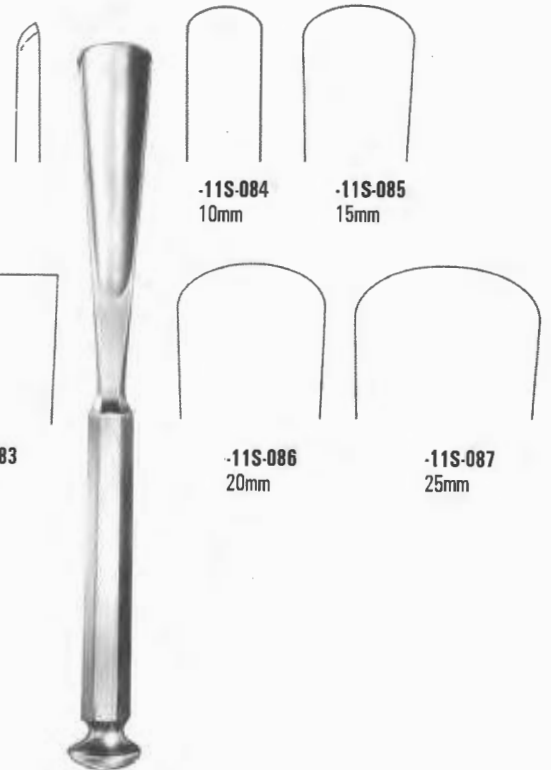

Stille Bone Gouge  
8" (20 cm)



# BONE SURGERY INSTRUMENTS

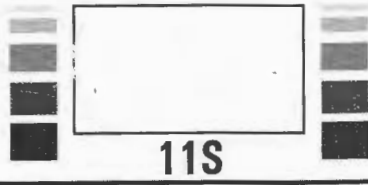

**11S**



**Williger Hammer**  
9½" (24 cm)

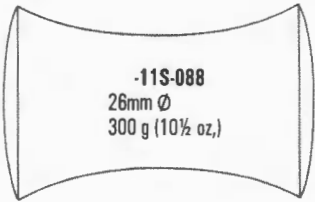

**-11S-088**  
26mm Ø  
300 g (10½ oz.)

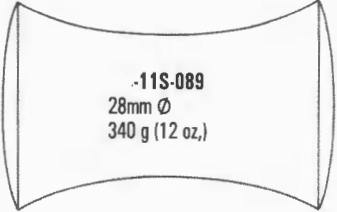

**-11S-089**  
28mm Ø  
340 g (12 oz.)

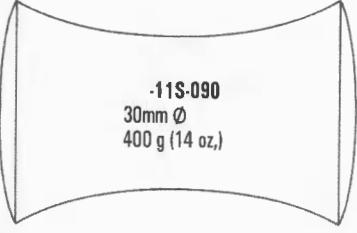

**-11S-090**  
30mm Ø  
400 g (14 oz.)



**-11S-091**  
**Gerog Mallet Hammer**  
Weight

Head Weight  
227 G



**Doyen Hammer**  
8¼" (21 cm)

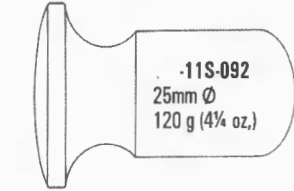

**-11S-092**  
25mm Ø  
120 g (4¼ oz.)

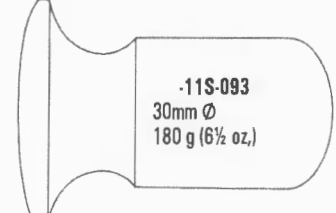

**-11S-093**  
30mm Ø  
180 g (6½ oz.)

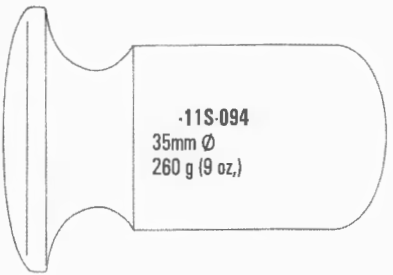

**-11S-094**  
35mm Ø  
260 g (9 oz.)



**Collin Hammer**  
8" (20 cm)

**TRI-11S-095**  
220 g (7¾ oz.)

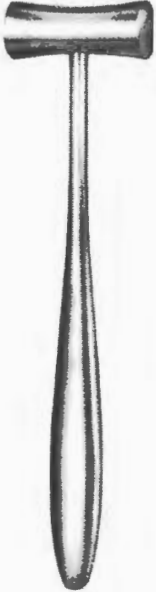

**Lucae Hammer**  
7½" (19 cm)

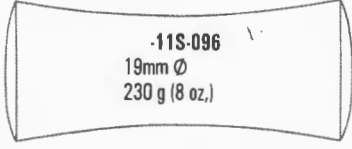

**-11S-096**  
19mm Ø  
230 g (8 oz.)

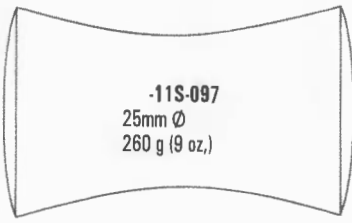

**-11S-097**  
25mm Ø  
260 g (9 oz.)

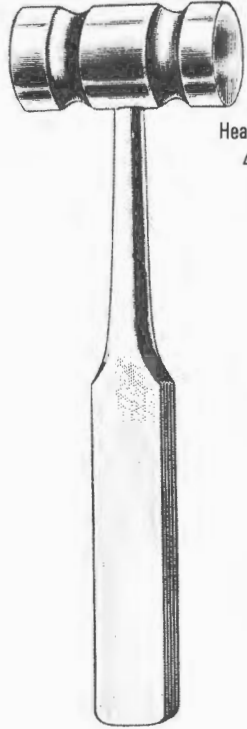

**-11S-098**  
**Miltex Mallet**  
11" (27.9cm)

Head Weight  
450 G

# BONE SURGERY INSTRUMENTS

11S

Straight

Curved

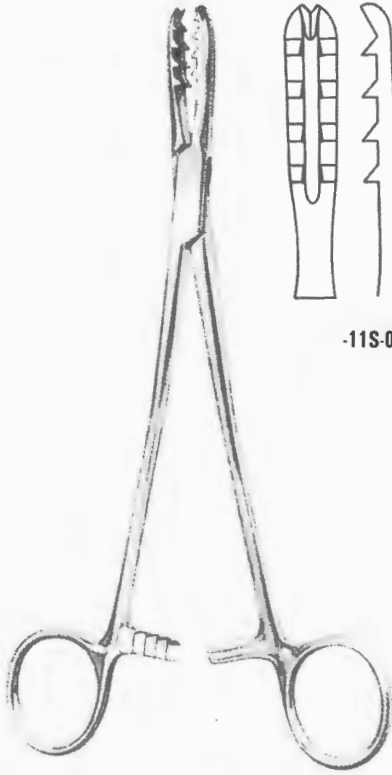

Bircher-Ganske Forceps  
8" (20 cm)

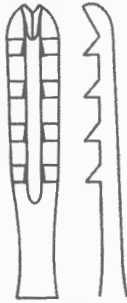

-11S-099



-11S-100

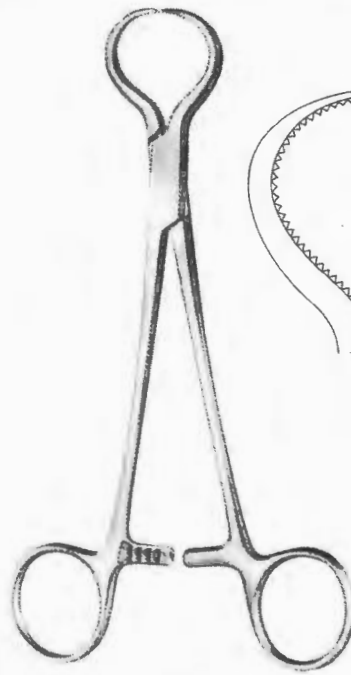

-11S-101  
Lewin  
7" (17,5 cm)



-11S-102  
Bone Holding Forceps  
5 1/4" (13,5cm)

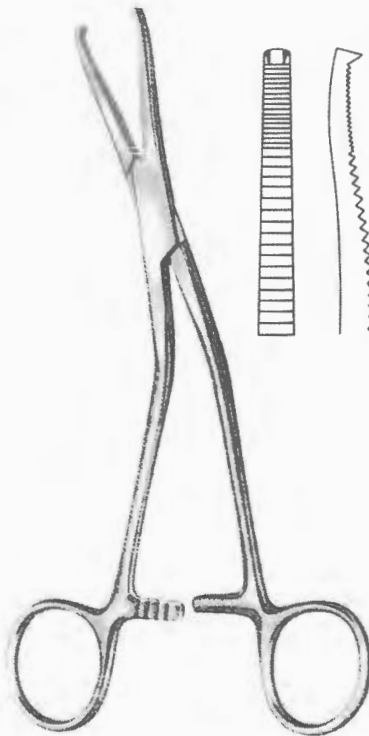

-11S-103  
Dingmann Bone Forceps  
7 1/2" (19 cm)

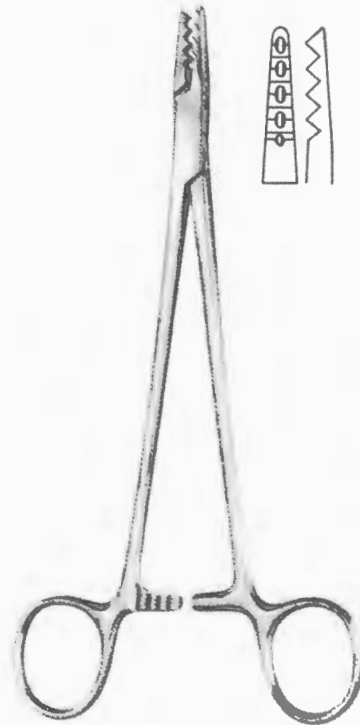
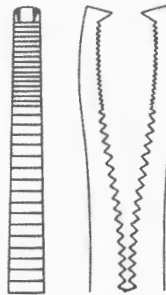

-11S-104  
Martin Bone Forceps  
7 1/2" (19 cm)



# BONE SURGERY INSTRUMENTS

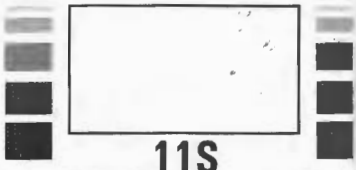

**-11S-105**  
Bone Holding Forceps  
5½" (14 cm)

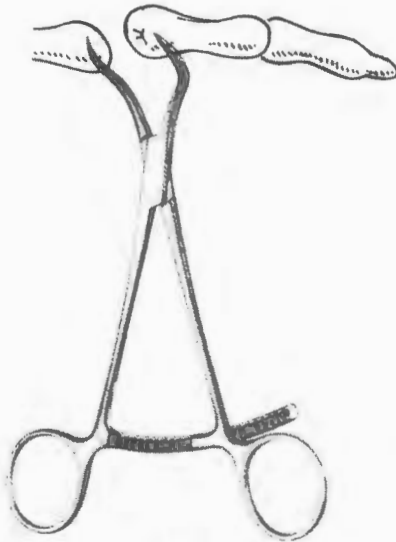

**-11S-106**  
Bone Holding Forceps  
5¼" (13,5cm)



**-11S-107**  
Langenbeck  
Bone Holding Forceps  
8¼" (21 cm)

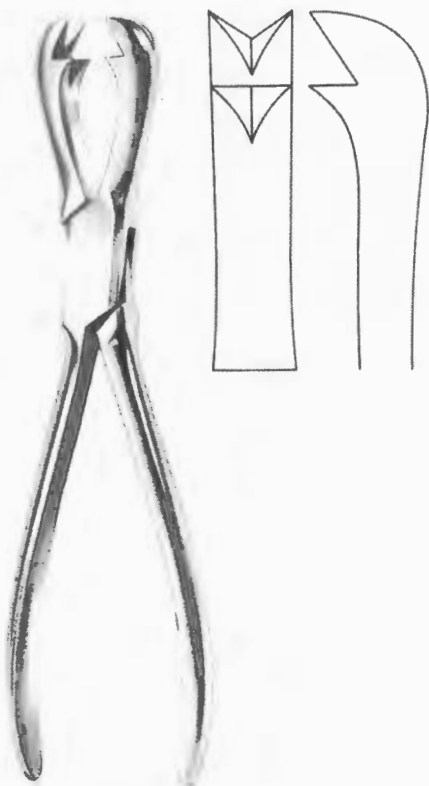

**-11S-108**  
Fergusson Bone Holding Forceps  
8¼" (21 cm)



**-11S-109**  
Frosch Bone Holding Forceps  
7" (18 cm)

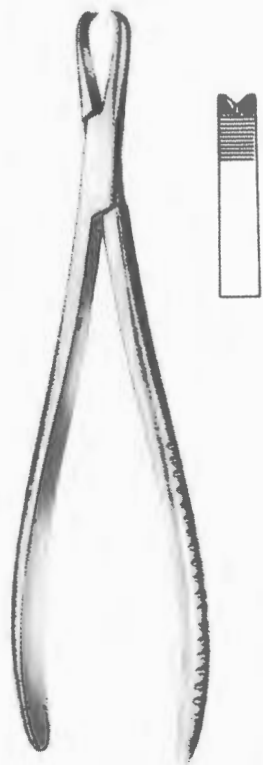

**-11S-110**  
Bone Holding Forceps  
8" (20 cm)

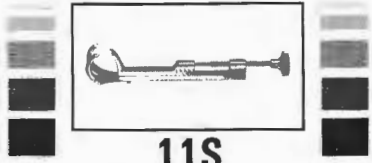

# BONE SURGERY INSTRUMENTS

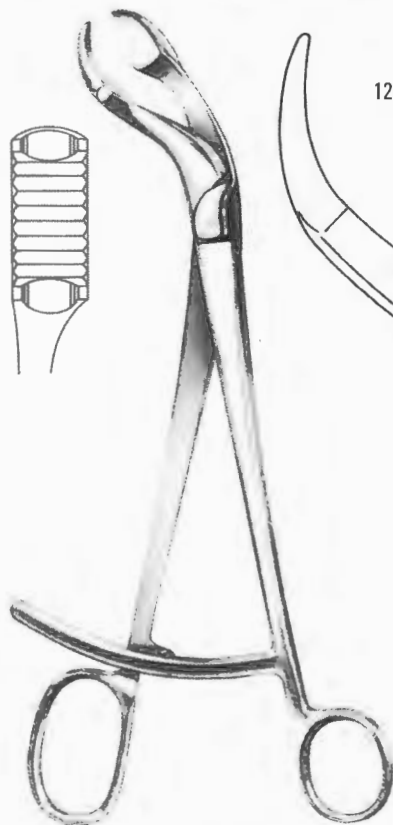

Verbrugge Bone Holding Forceps

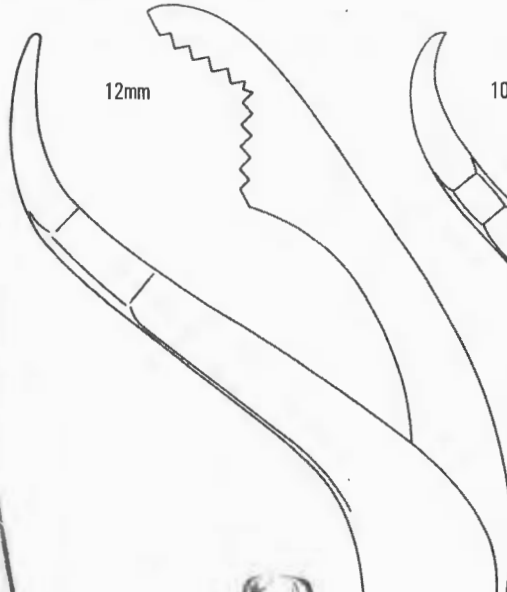

12mm

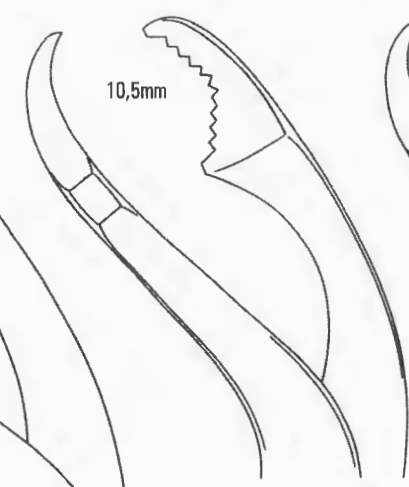

10,5mm

-11S-112  
10½" (26 cm)

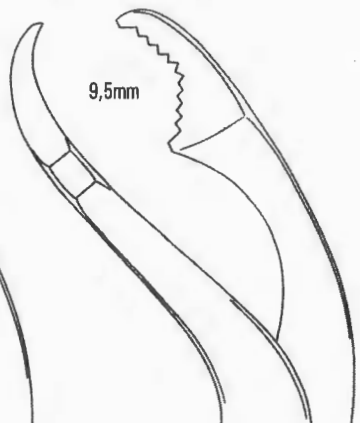

9,5mm

-11S-113  
10" (25 cm)



-11S-111  
11" (27 cm)



-11S-116  
LANE Bone Holding Forceps  
13" (33 cm)

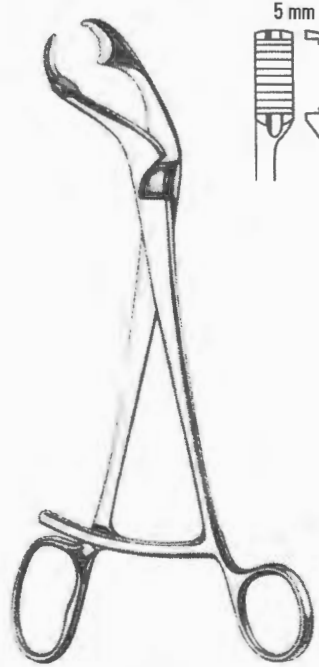

-11S-114  
Verbrugge Bone Holding Forceps  
6¾" (17,5cm)



5 mm

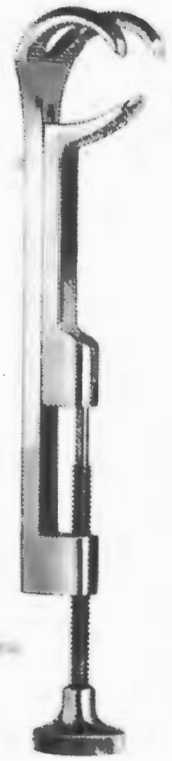

-11S-117  
Lowmann Bone Holding Forceps  
7" (18 cm)

# BONE SURGERY INSTRUMENTS

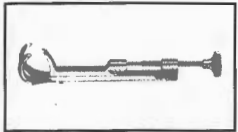

11S

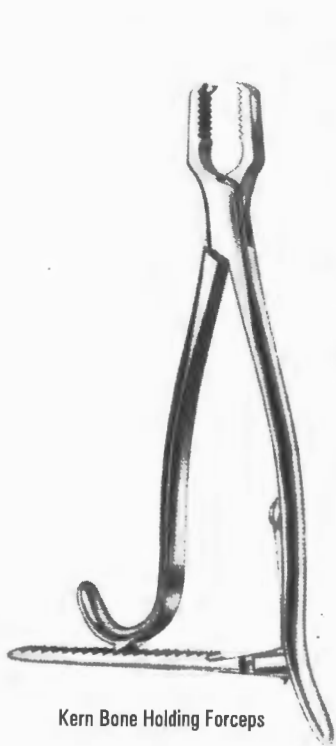

-11S-118  
6 3/4" (17 cm)

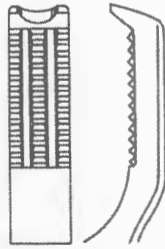

-11S-119  
8 1/4" (21 cm)



-11S-120  
Semb Bone Holding Forceps  
7 1/2" (19 cm)

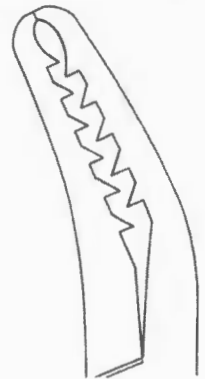

ARTICLE #	SIZE
-11S-121	9" (23 cm)
-11S-122	10 1/4" (26 cm)

Farabeuf Bone Holding Forceps

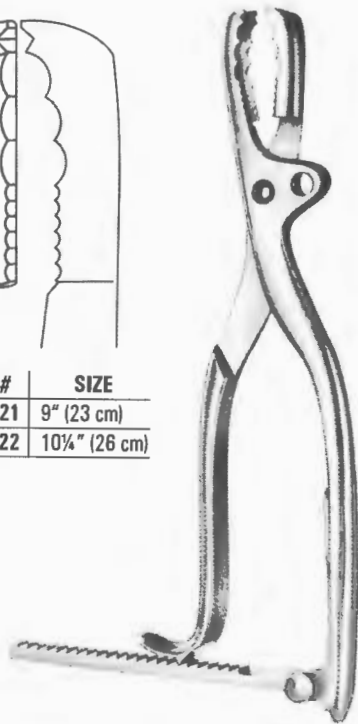
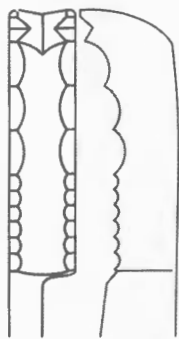

-11S-123  
Farabeuf-Lambotte  
Bone Holding Forceps  
10 1/4" (26 cm)

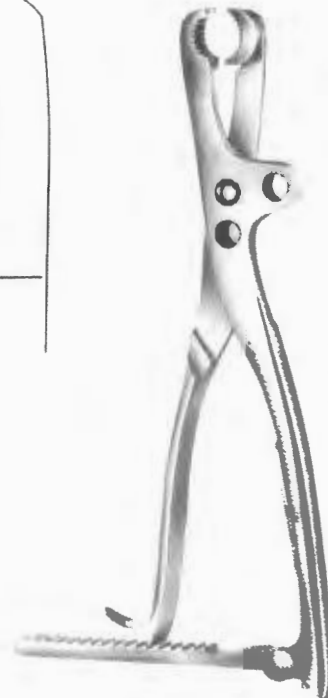
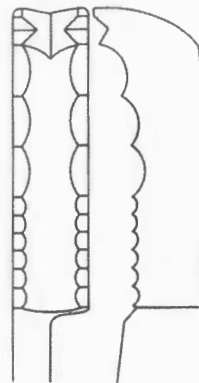

Lambotte Bone Holding Forceps

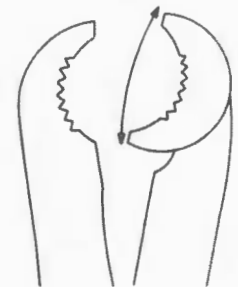

ARTICLE #	SIZE
-11S-124	8" (22 cm)
-11S-125	10 1/2" (27 cm)
-11S-126	12" (30 cm)

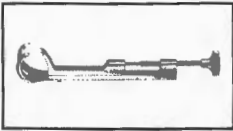

11S

# BONE SURGERY INSTRUMENTS



**-11S-127**  
Hennig Spreader  
11" (28cm)

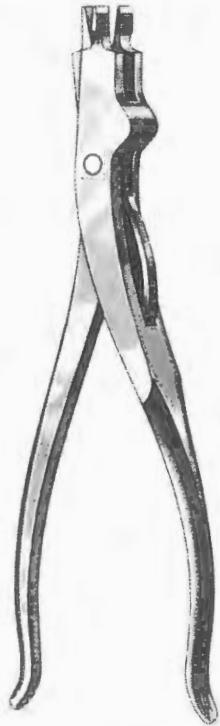

**-11S-128**  
3 Prong Cast Spreader  
9" (23 cm)

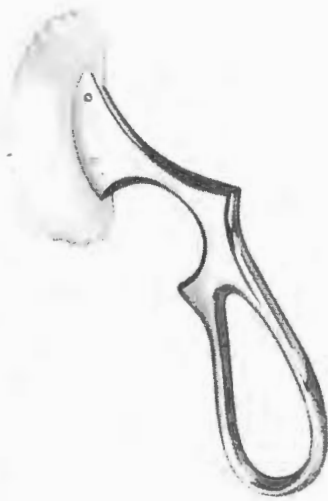

**-11S-129**  
Eangle Saw

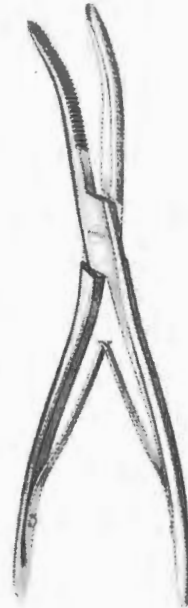

Wolfe Buechier Cast Breaker



**-11S-130**  
7" (18 cm)



**-11S-131**  
10" (24 cm)



Stille- Cast Shears

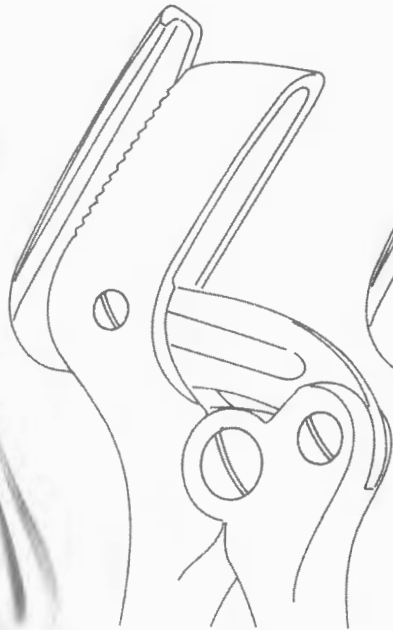

**-11S-132**  
8" (23 cm)

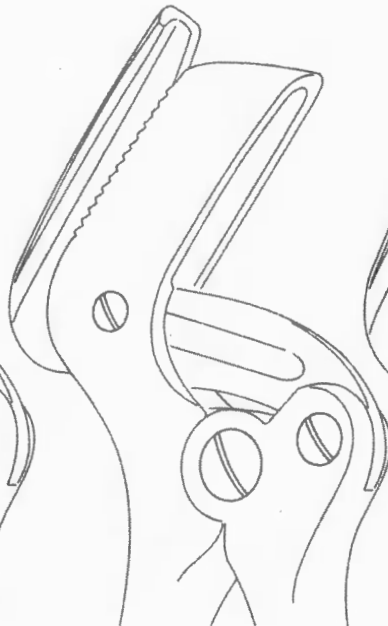

**-11S-133**  
11" (26 cm)

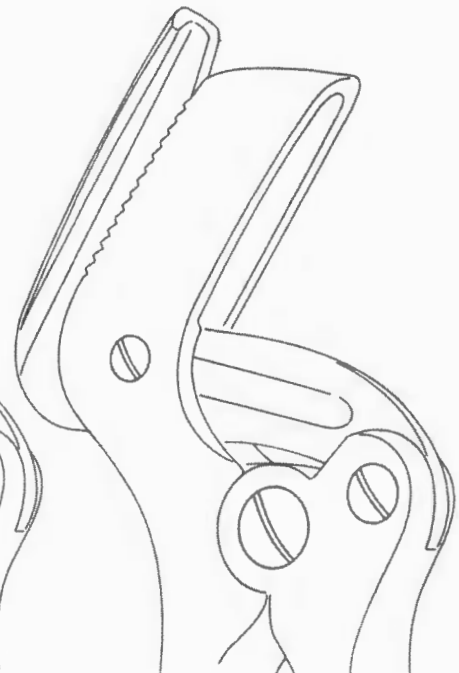

**-11S-134**  
15" (37 cm)

# BONE SURGERY INSTRUMENTS

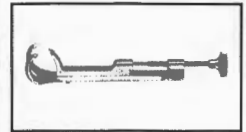

11S

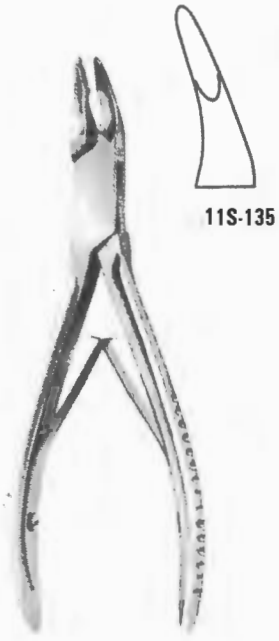

11S-135



-11S-136



-11S-137



-11S-138



-11S-139



-11S-140



-11S-141

Blumenthal Bone Rongeur  
6" (15 cm)

Luer Bone Rongeur  
7" (15 cm)

Hartmann Bone Rongeur  
7" (18.5cm)



-11S-142



-11S-143

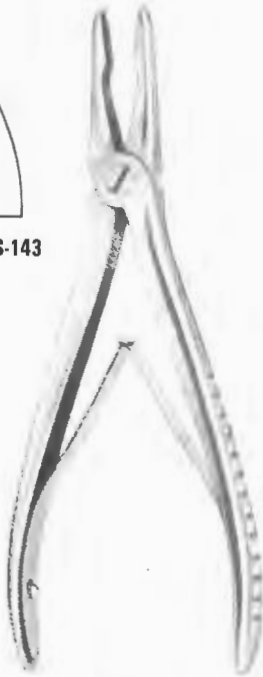

-11S-144



-11S-145



-11S-146

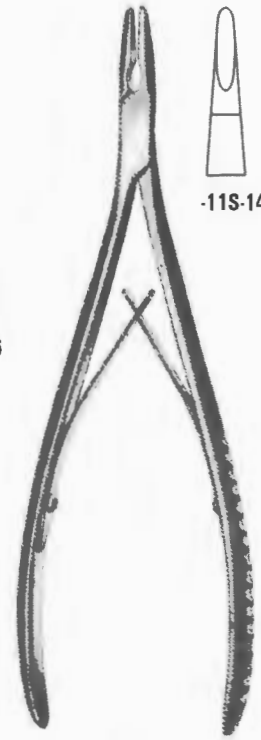

-11S-147

Luer Bone Rongeur  
7" (18 cm)

Jansen Bone Rongeur Forceps  
7" (18 cm)

Lempert Bone Rongeur Forceps  
7 1/2" (19 cm)



11S

# BONE SURGERY INSTRUMENTS

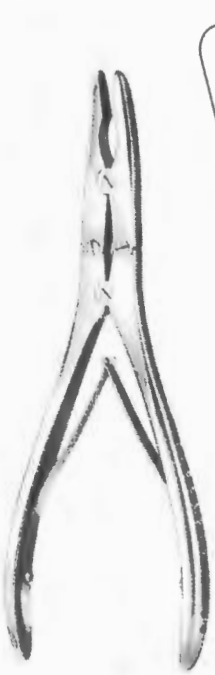

**-11S-148**  
Ruskin Bone Rongeur Forceps  
7" (18 cm)



**-11S-149**  
Ruskin Bone Rongeur Forceps  
9" (23 cm)

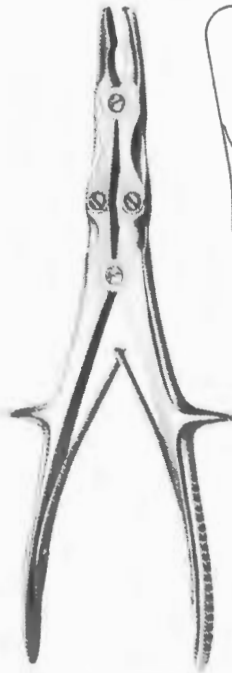

**-11S-150**  
Stille-Ruskin  
Bone Rongeur Forceps  
9" (23 cm)

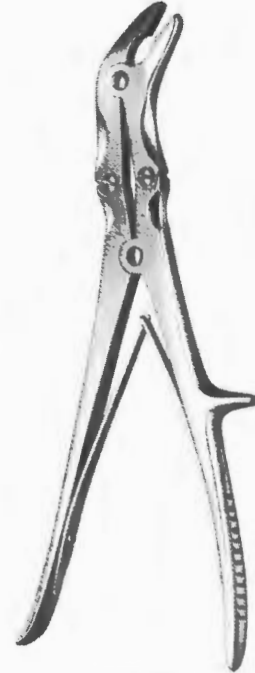

**-11S-151**  
Stille Bone Rongeur Forceps  
9" (23 cm)



**-11S-155**

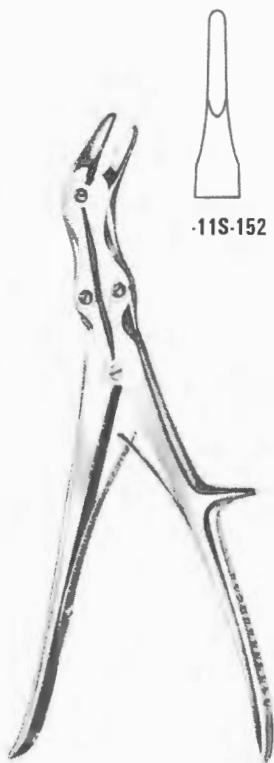

**-11S-152**



**-11S-153**



**-11S-154**

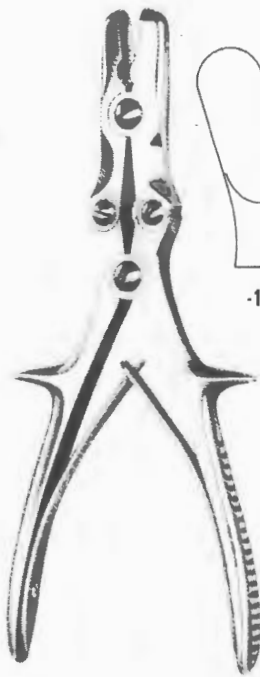

**-11S-156**

**Echlin Bone Rongeur Forceps**  
9" (23 cm)

**Stille-Luer Bone Rongeur Forceps**  
8 1/2" (22 cm)

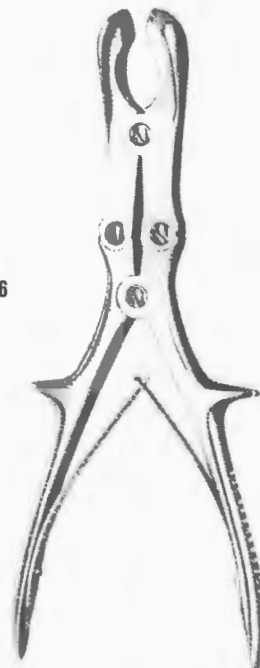

**-11S-157**  
Semb Bone Rongeur Forceps  
9" (23 cm)

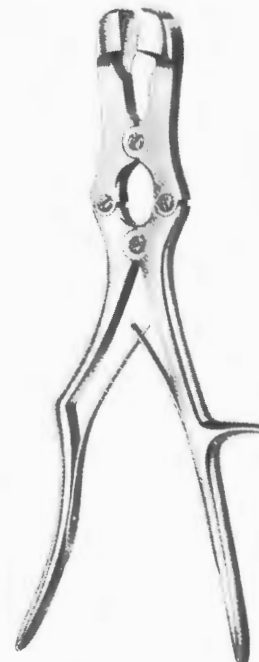

**Sauerbruch  
Bone Rongeur Forceps**  
12" (30 cm)

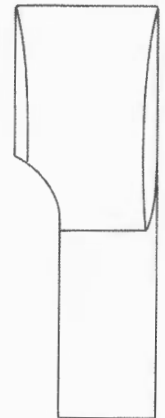

**-11S-158**

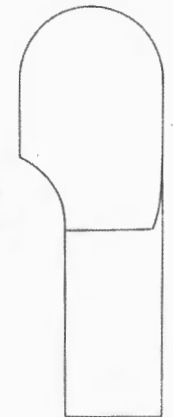

**-11S-159**



# BONE SURGERY INSTRUMENTS

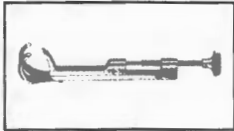

11S



Liston Bone Cutting Forceps  
Straight



-11S-160  
5½" (14 cm)



-11S-161  
6¾" (17 cm)



-11S-162  
7½" (19 cm)



-11S-163  
8¾" (22 cm)



Liston Bone Cutting Forceps  
Curved



-11S-164  
5½" (14 cm)



-11S-165  
6¾" (17 cm)



-11S-166  
7½" (19 cm)



-11S-167  
8¾" (22 cm)

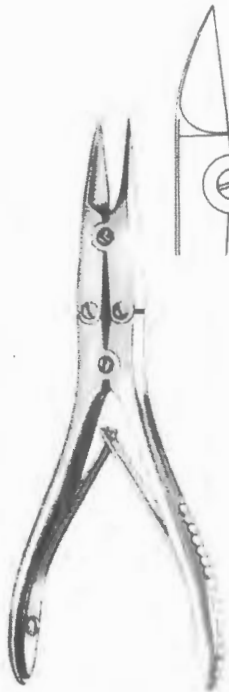

-11S-168  
Rusking Bone Cutting Forceps  
6" (15 cm)

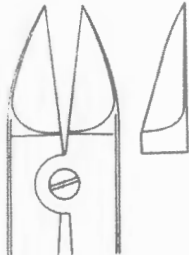

-11S-169  
Markwalder Bone Cutting Forceps  
8" (20 cm)

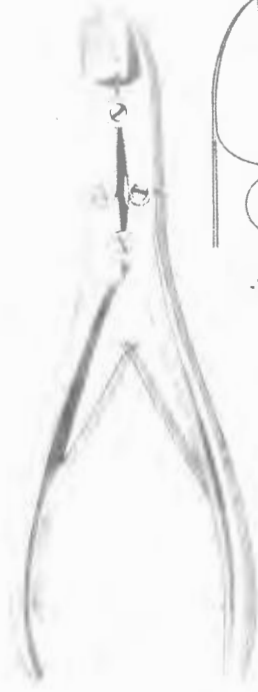

Ruskin-Liston  
Bone Cutting Forceps  
7½" (18.5 cm)

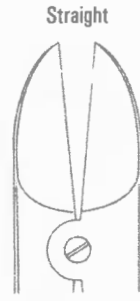

-11S-170



-11S-171

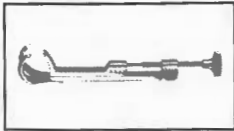

11S

# BONE SURGERY INSTRUMENTS

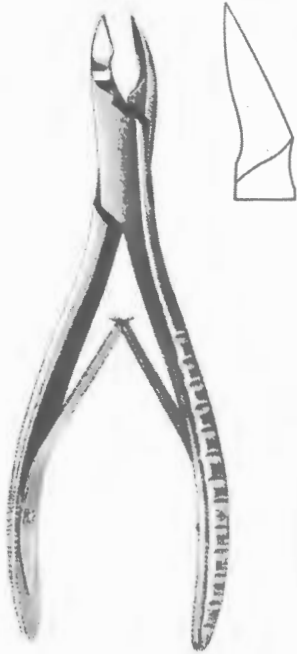

-11S-172  
Cleveland  
Bone Cutting Forceps  
7" (17 cm)



-11S-173  
Cleveland  
Bone Cutting Forceps  
6" (15 cm)

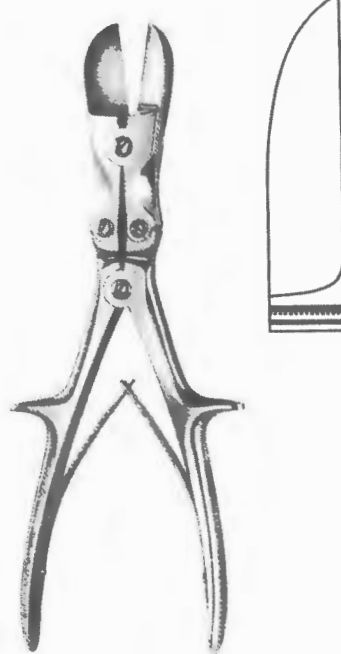

-11S-174  
Stille-Liston  
Bone Cutting Forceps, Straight  
10 1/2" (27 cm)

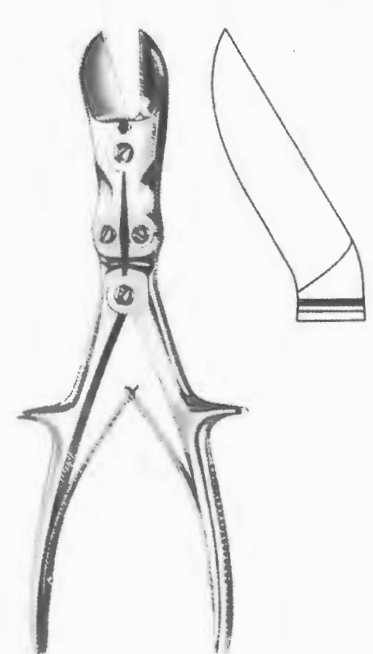

-11S-175  
Stille-Liston  
Bone Cutting Forceps, Curved  
10 1/2" (27 cm)

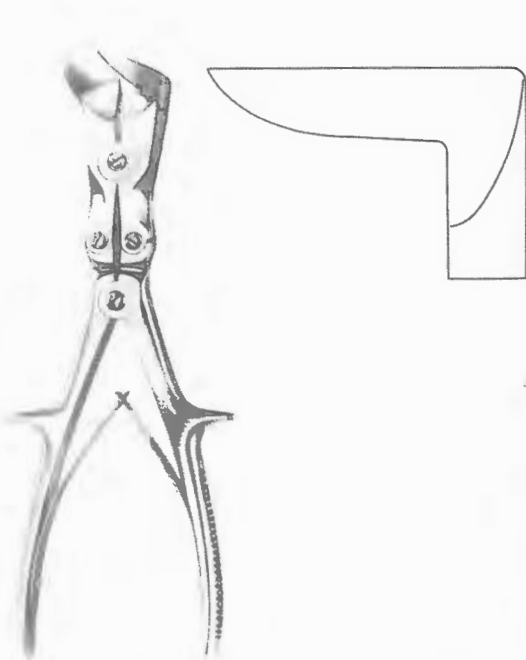

-11S-177  
Stille-Liston  
Bone Cutting Forceps  
10 1/2", Curved

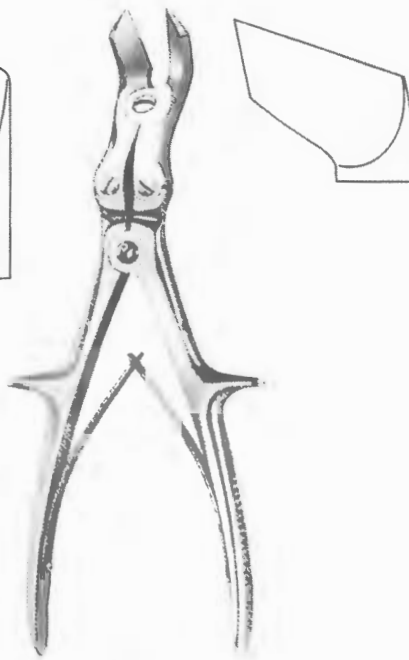

-11S-178  
Liston-Key  
Bone Cutting Forceps  
10 1/2" (27 cm)

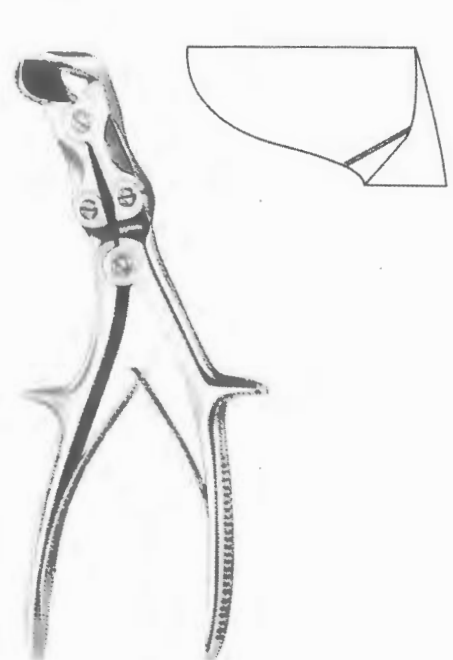

-11S-179  
Semb  
Bone Cutting Forceps  
9" (24 cm)

# BONE SURGERY INSTRUMENTS

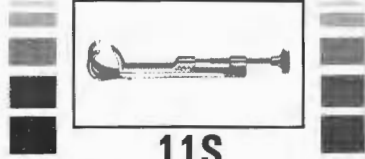

-11S-180  
Flat Nose Plier  
6½" (17 cm)



11S-181  
Grip Plier  
7" (18 cm)

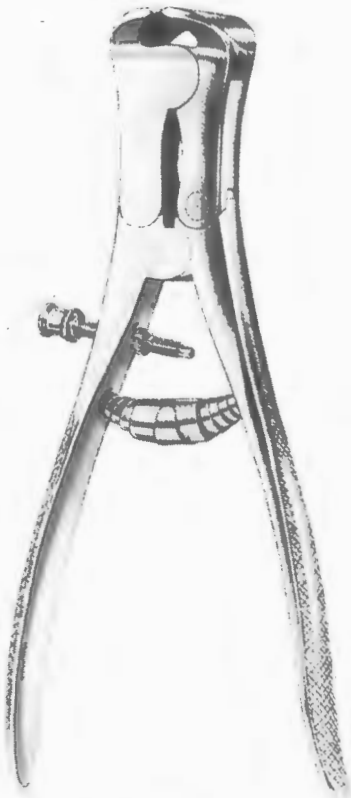

-11S-182  
Wire Cutting Plier  
9" (23 cm)



-11S-183  
Bolt Cutter  
12" (30 cm)



-11S-184  
Pin Cutter  
18½" (47 cm)

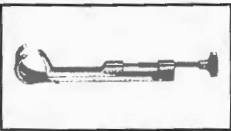

11S

# BONE SURGERY INSTRUMENTS



-11S-185  
Wire Cutting Pliers  
6" (16 cm)

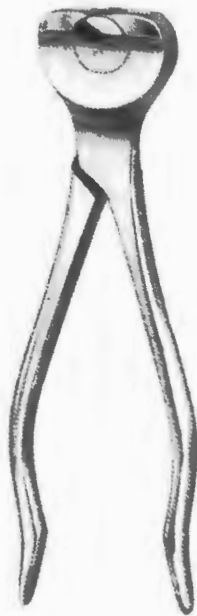

-11S-186  
Diamant Wire Cutting Pliers  
6" (16 cm)

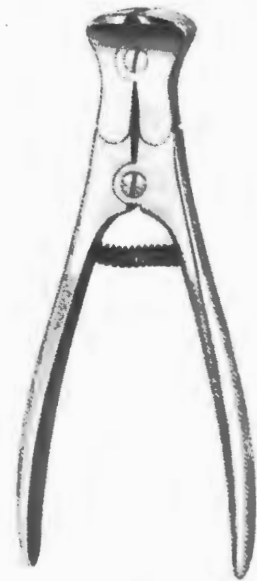

-11S-187  
Diamant Wire Cutting Pliers  
6" (15 cm)

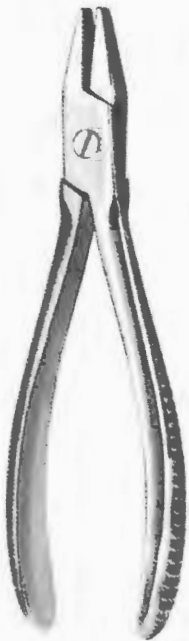

-11S-188  
Flat Nose Pliers  
7" (17 cm)

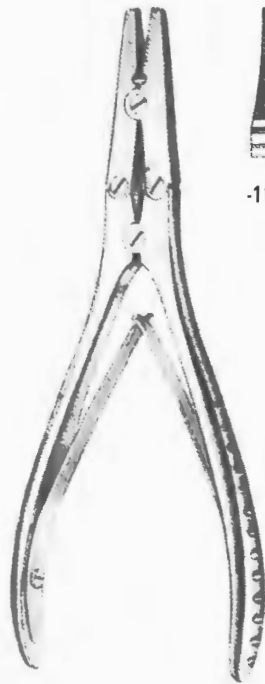

Flat Nose Pliers  
7" (18 cm)



-11S-189



-11S-190



-11S-191



Flat Nose Pliers  
7" (18 cm)



-11S-192

# GYNACOLOGICAL & OBSTETRICAL INSTRUMENTS

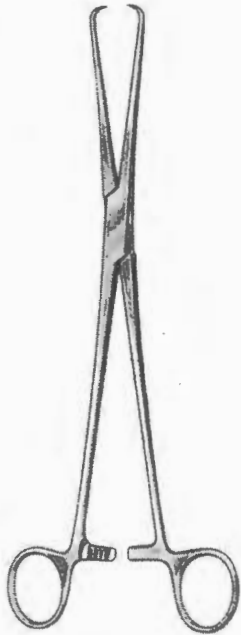
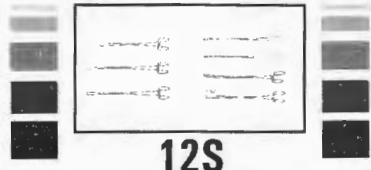

**-12S-001**  
Pozzi Tenaculum Forceps  
10" (25 cm)

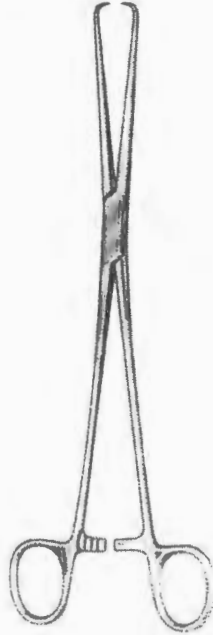

**-12S-002**  
Schroeder Tenaculum Forceps  
10" (25 cm)

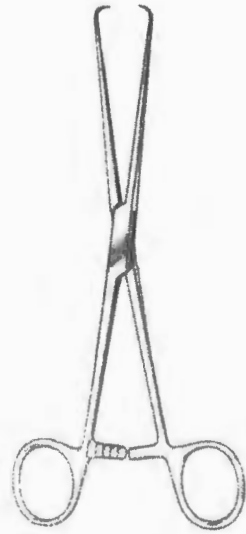

**-12S-003**  
Barrett Tenaculum Forceps  
7" (18 cm)

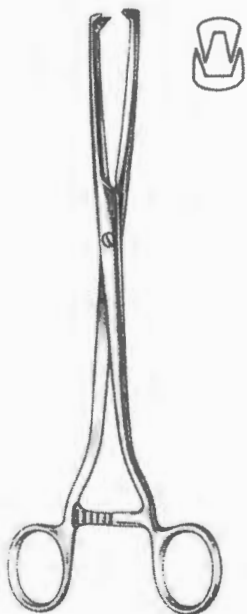

Meseux Tenaculum Forceps, Straight

ARTICLE #	SIZE	WIDE AT TIP
-12S-004	9½" (24cm)	6 mm
-12S-005	9½" (24cm)	8 mm
-12S-006	9½" (24cm)	10 mm

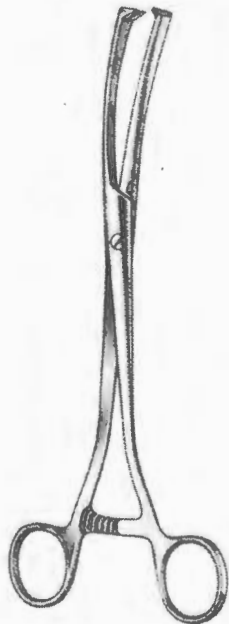

Meseux Curved Tenaculum Forceps

ARTICLE #	SIZE	WIDE AT TIP
-12S-007	9½" (24cm)	6 mm
-12S-008	9½" (24cm)	8 mm
-12S-009	9½" (24cm)	10 mm

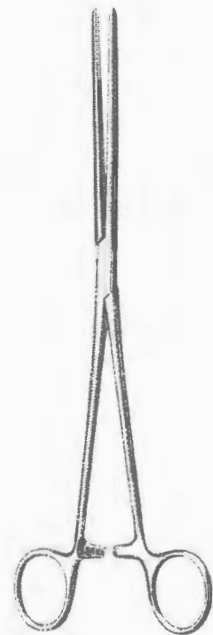

**-12S-010**  
Bozeman Uterine Dressing Forceps  
10½" (26,5 cm)

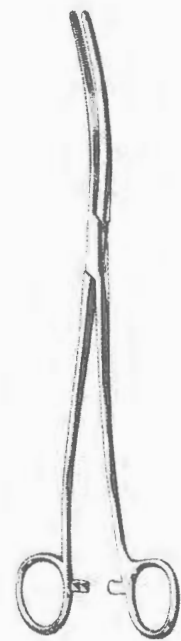

**-12S-011**  
Bozeman Uterine Dressing Forceps  
10½" (26,5 cm)



12S

# GYNACOLOGICAL & OBSTETRICAL INSTRUMENTS

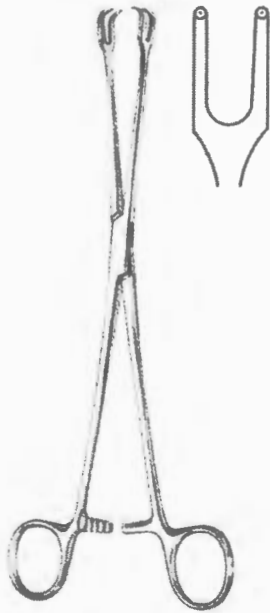

**-12S-012**  
Schroeder 2x2 Tenaculum Forceps  
9½" (24 cm)



**-12S-013**  
Schroeder 2x2 Curved  
Tenaculum Forceps  
9¾" (25 cm)

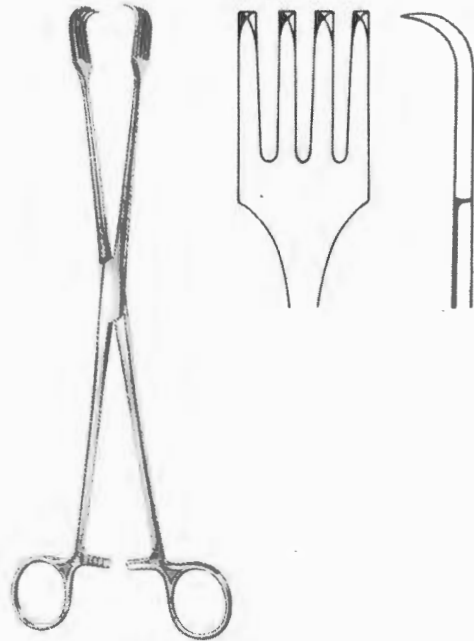

**-12S-014**  
Pratt Tenaculum Forceps  
10" (26 cm)

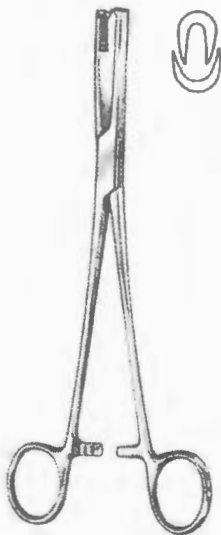

**-12S-015**  
Jacobs Tenaculum Forceps  
8¾" (21 cm)



**-12S-016**  
Jacobs Tenaculum Forceps  
8¾" (21 cm)

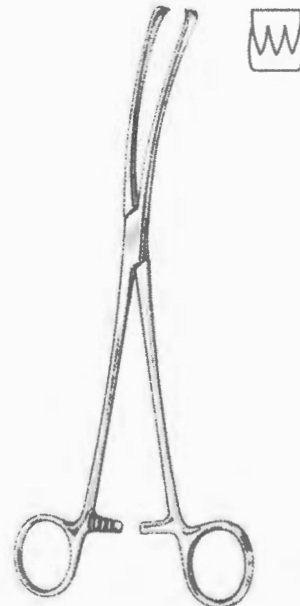

**-12S-017**  
Teale Tenaculum Forceps  
9" (23 cm)

# GYNACOLOGICAL & OBSTETRICAL INSTRUMENTS



12S

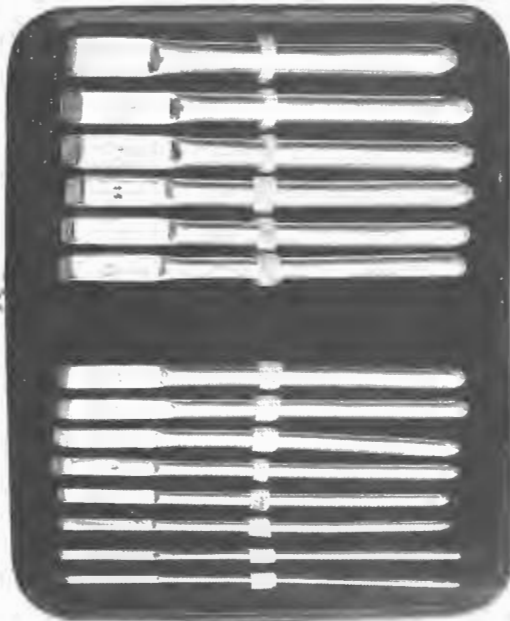

Hegar Dilator, Single End

-12S-018A	Set of 14 Pcs	14 to 17 mm
-12S-018B	Set of 26 Pcs	1 to 26 mm

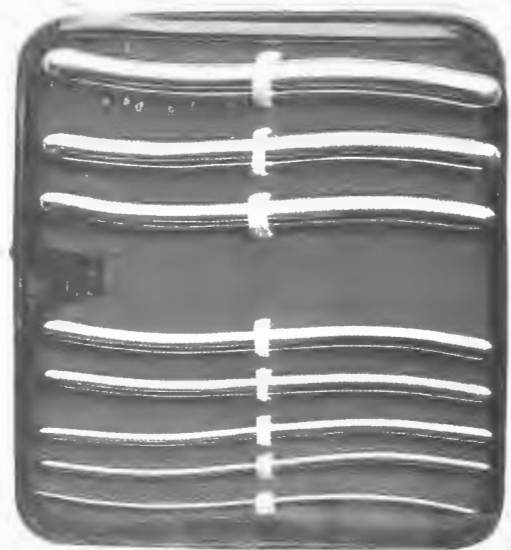

Hegar Dilator, Double End

-12S-018C	Set of 8 Pcs	3/4 to 17/18 mm
-12S-018D	Set of 13 Pcs	1/2 to 25/26 mm

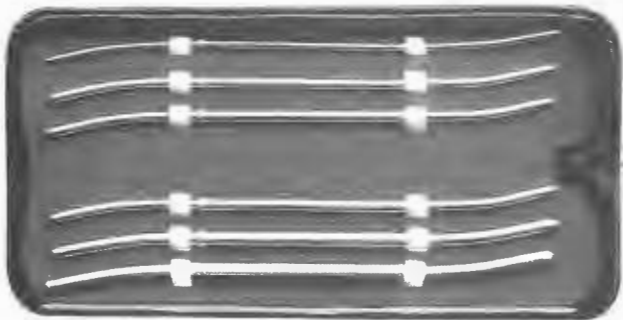

-12S-018E

Hank Uterine Dilator  
Set of 6 Pcs 9/10 to 19/20 FR

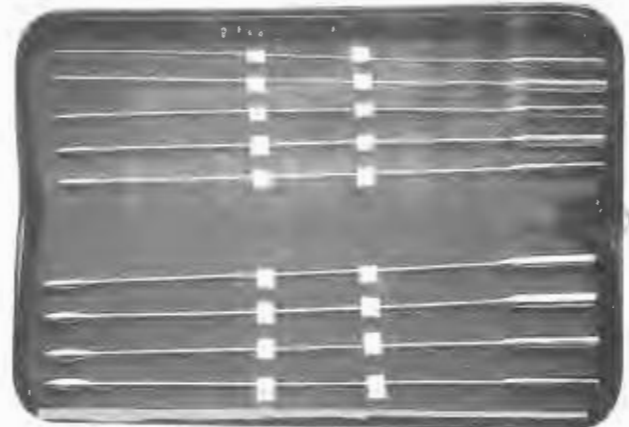

-12S-018F

De-Bakey Vascular Dilator  
Set of 9 Pcs, 2, 2.5, 3, 3.5, 4, 4.5, 5, 7, 9 mm

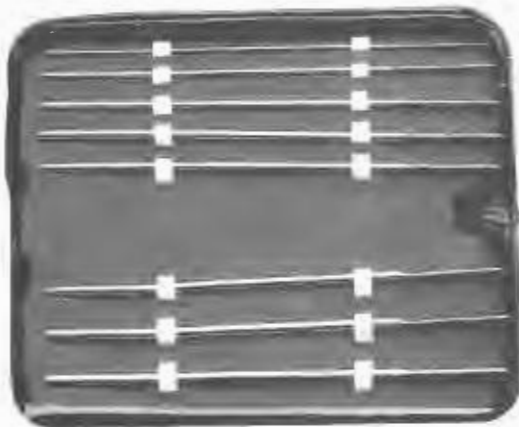

-12S-018G

Dittel Sound Straight  
Set of 8 Pcs, 8,10,12,14,16,18,20,22 FR

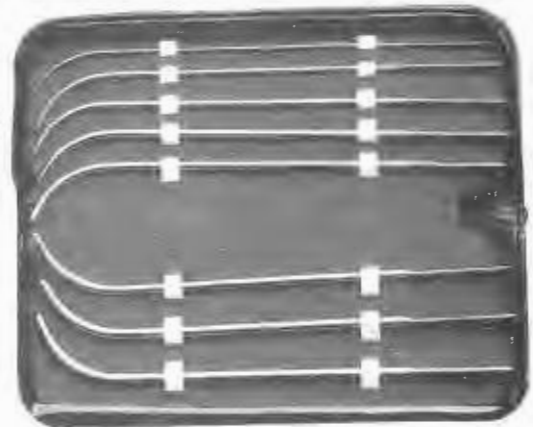

-12S-018H

Van Buren Sound  
Set of 8 Pcs, 8,10,12,14,16,18,20,22 FR

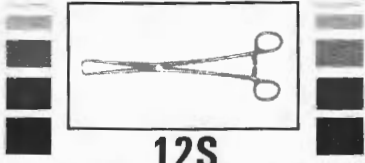

# GYNACOLOGICAL & OBSTETRICAL INSTRUMENTS

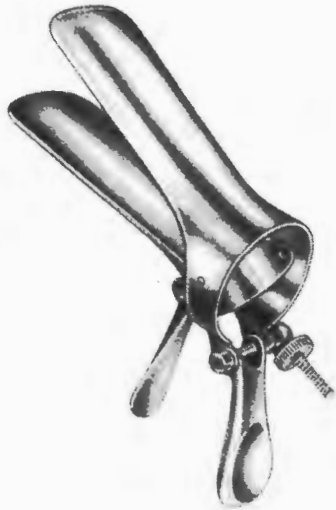

Cusco Vaginal Specula

ARTICLE #	SIZE
-12S-020	75 x 32mm
-12S-021	85 x 35mm
-12S-022	100 x 35mm
-12S-023	75 x 17mm

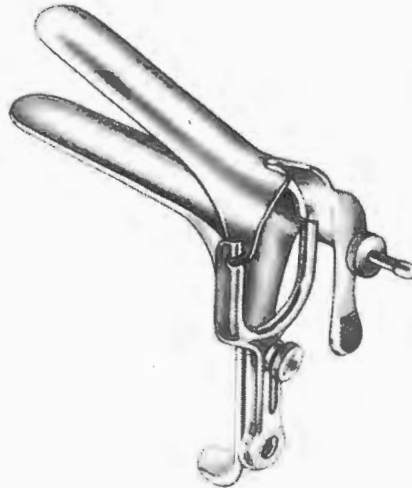

Pederson Vaginal Specula

ARTICLE #	SIZE
-12S-024	75 x 13mm
-12S-025	100 x 22mm
-12S-026	120 x 25mm

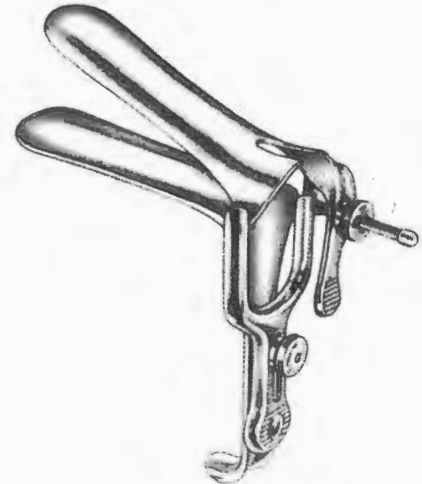

Grave Vaginal Specula

ARTICLE #	SIZE
-12S-027	75 x 20mm
-12S-028	95 x 35mm
-12S-029	115 x 35mm



Collin Vaginal Specula

ARTICLE #	SIZE
-12S-030	85 x 30mm
-12S-031	100 x 35mm
-12S-032	110 x 40mm



Sims Vaginal Specula

ARTICLE #	SIZE
-12S-033	60 x 25/30mm
-12S-034	70 x 30/35mm
-12S-035	80 x 35/40mm



Auvard Weighted Vaginal Specula

ARTICLE #	
-12S-036	2 lbs
-12S-037	2,5 lbs
-12S-038	3 lbs



-12S-039

Weighted Vaginal Specula 2,5 lbs



# GYNACOLOGICAL & OBSTETRICAL INSTRUMENTS

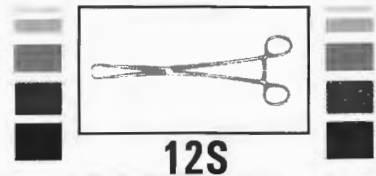

Kristeller Vaginal Specula

-12S-040	#000	70 x 27mm
-12S-041	#00	80 x 30mm
-12S-042	#0	90 x 36mm
-12S-043	#1	110 x 27mm
-12S-044	#2	110 x 30mm
-12S-045	#3	110 x 36mm



Kristeller Vaginal Specula

-12S-046	#000	75 x 23mm
-12S-047	#00	85 x 26mm
-12S-048	#0	100 x 32mm
-12S-049	#1	115 x 23mm
-12S-050	#2	115 x 26mm
-12S-051	#3	115 x 32mm



Kristeller Vaginal Specula Set

-12S-052	#000
-12S-053	#00
-12S-054	#0
-12S-055	#1
-12S-056	#2
-12S-057	#3



Doyen Vaginal Specula

-12S-058	55 x 35mm
-12S-059	85 x 35mm
-12S-060	115 x 35mm



Doyen Vaginal Specula

-12S-061	55 x 45mm
-12S-062	85 x 45mm
-12S-063	115 x 45mm



Doyen Vaginal Specula

-12S-064	55 x 60mm
-12S-065	85 x 60mm
-12S-066	115 x 60mm

# GYNAECOLOGICAL & OBSTETRICAL INSTRUMENTS



**12S**

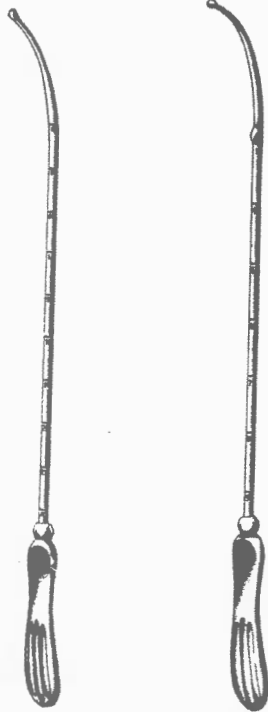

**-12S-067**  
Sims Uterine Sound  
13" (32 cm)

**-12S-068**  
Martin Uterine Sound  
13" (32 cm)



Sims Uterine Curettes  
12½" (31 cm)



Fig. 00  
-12S-069



Fig. 0  
-12S-070



Fig. 1  
-12S-071



Fig. 2  
-12S-072



Fig. 3  
-12S-073



Fig. 4  
-12S-074



Fig. 5  
-12S-075



Fig. 6  
-12S-076



Thomas Uterine Curettes  
12½" (31 cm)



Fig. 1  
-12S-077



Fig. 2  
-12S-078



Fig. 3  
-12S-079



Fig. 4  
-12S-080



Fig. 5  
-12S-081



Fig. 6  
-12S-082



**-12S-083**  
Kogan Endocervical Speculum  
9½" (24 cm)

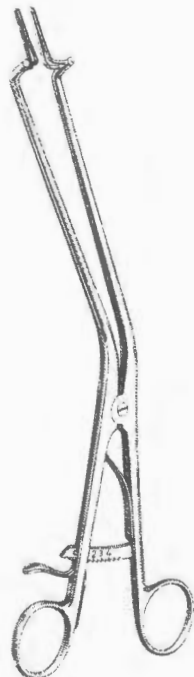

**-12S-084**  
Kogan Endocervical Speculum  
11" (28 cm)



**-12S-085**  
Leep Lateral Vaginal Retractor  
8¾" (21 cm)

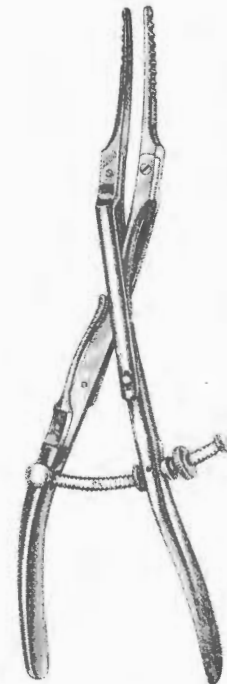

**-12S-086**  
Goodell Uterine Dilator  
10½" (26,5 cm)

# GYNACOLOGICAL & OBSTETRICAL INSTRUMENTS

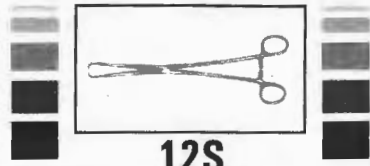

**-12S-087**  
Gaylor Uterine Biopsy Forceps  
8½" (21,5 cm)

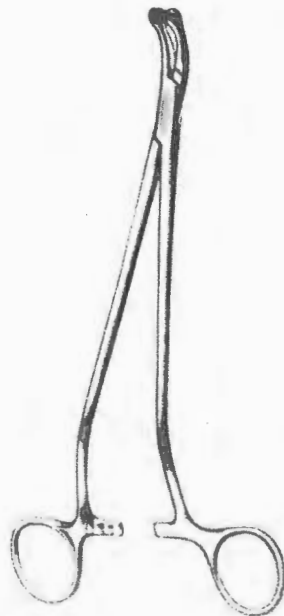

Thomas-Gaylor Uterine Biopsy Forceps

ARTICLE #	SIZE
-12S-088	8½" (21,5 cm)
-12S-089	9½" (24 cm)

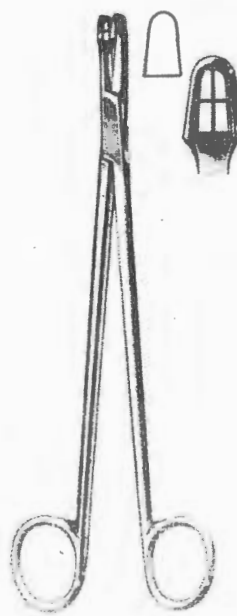

**-12S-090**  
Schubert Uterine Biopsy Forceps  
8½" (21,5 cm)

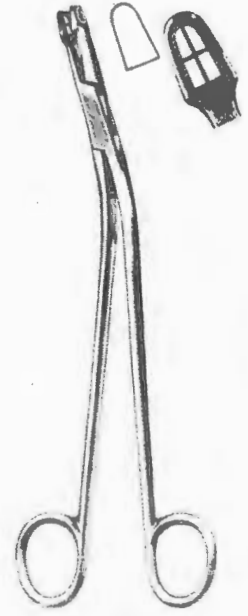

**-12S-091**  
Schubert Uterine Biopsy Forceps  
8½" (21,5 cm)

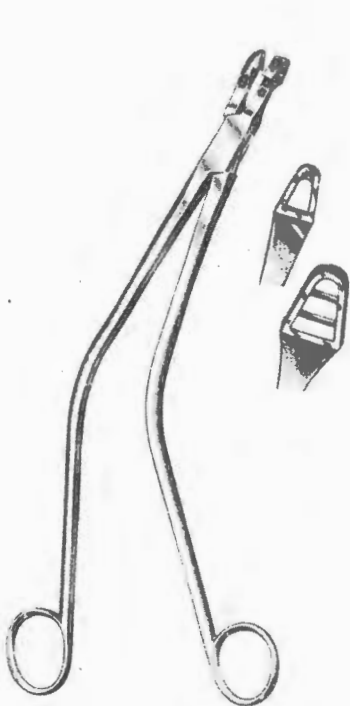

**-12S-092**  
Schubert Uterine Biopsy Forceps  
11" (28 cm)

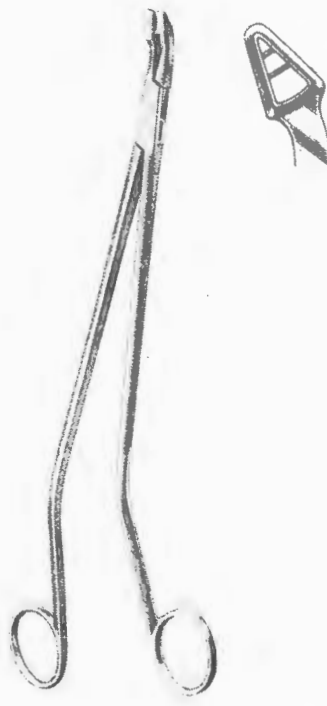

**-12S-093**  
Schubert Uterine Biopsy Forceps  
11" (28 cm)

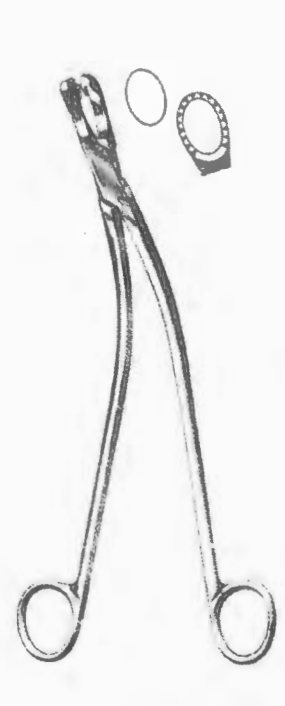

**-12S-094**  
Gellborn Uterine Biopsy Forceps  
9½" (24 cm)

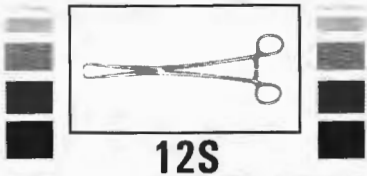

# GYNAECOLOGICAL & OBSTETRICAL INSTRUMENTS

SHAFT

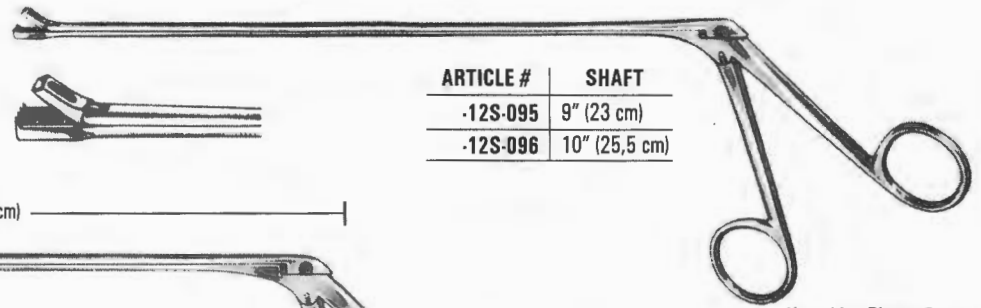

ARTICLE #	SHAFT
-12S-095	9" (23 cm)
-12S-096	10" (25,5 cm)

Kevorkian Biopsy Forceps

9 1/2" (24 cm)



Schumacher Biopsy Forceps  
9 1/2" (24 cm)



-12S-097  
Fig. 1  
5 mm



-12S-098  
Fig. 2  
7 mm

SHAFT

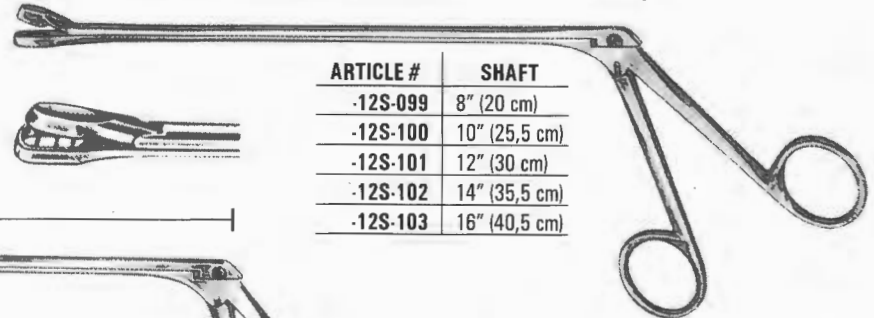

ARTICLE #	SHAFT
-12S-099	8" (20 cm)
-12S-100	10" (25,5 cm)
-12S-101	12" (30 cm)
-12S-102	14" (35,5 cm)
-12S-103	16" (40,5 cm)

Doyen Biopsy Forceps

9" (23 cm)

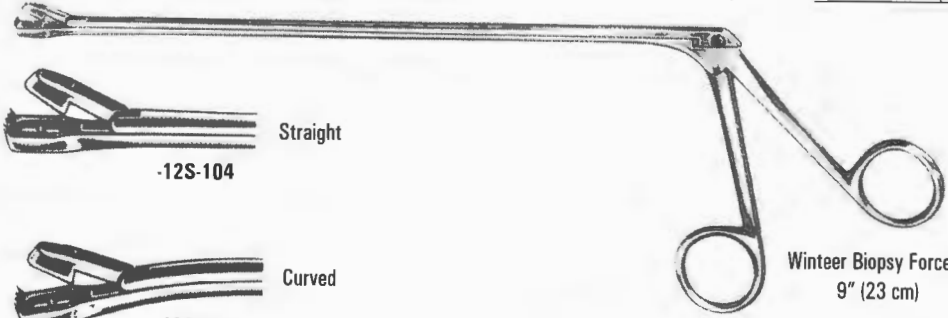

Winter Biopsy Forceps  
9" (23 cm)

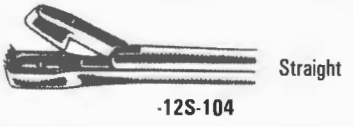

SHAFT

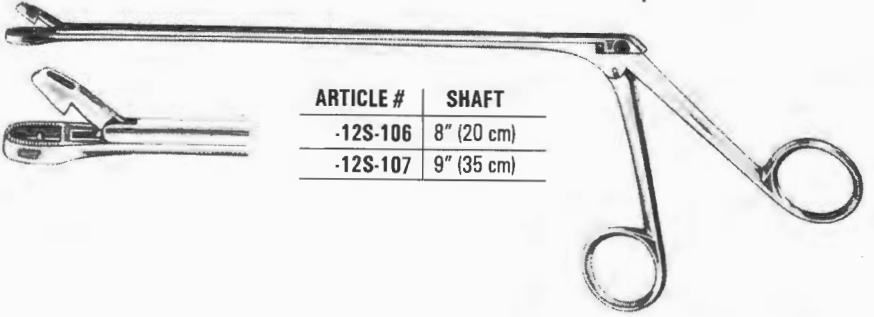

ARTICLE #	SHAFT
-12S-106	8" (20 cm)
-12S-107	9" (35 cm)

Eppendorf Biopsy Forceps

# GYNAECOLOGICAL & OBSTETRICAL INSTRUMENTS

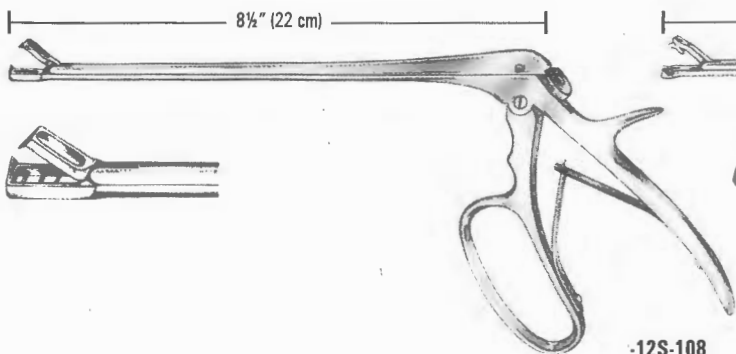
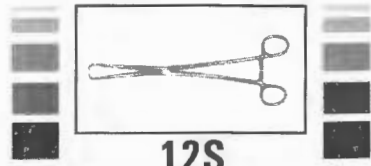

**-12S-108**  
Tischler-Kevorkian Biopsy Forceps

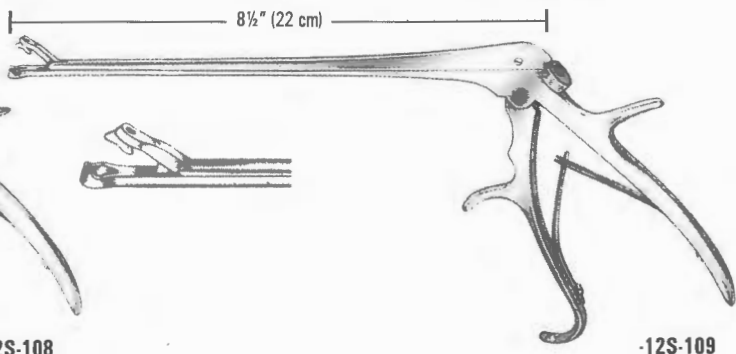

**-12S-109**  
Burke Biopsy Forceps

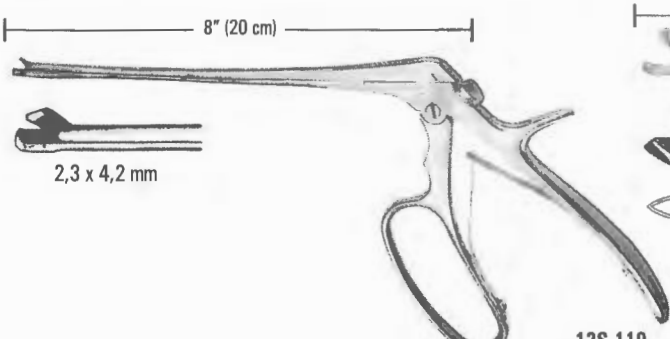

**-12S-110**  
Baby-Tischler Biopsy Forceps

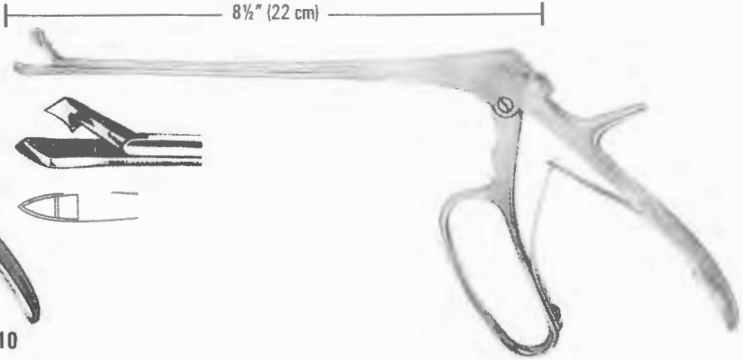

**-12S-111**  
Tischler Biopsy Forceps

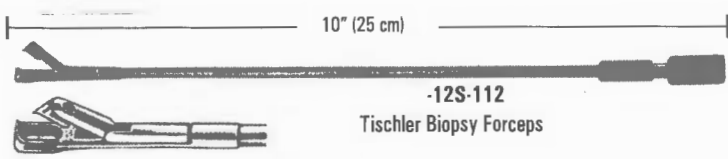

**-12S-112**  
Tischler Biopsy Forceps

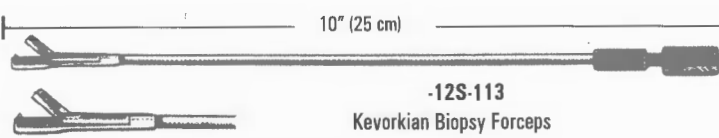

**-12S-113**  
Kevorkian Biopsy Forceps

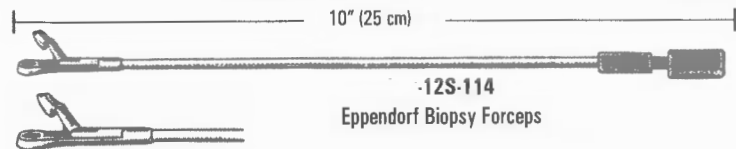

**-12S-114**  
Eppendorf Biopsy Forceps

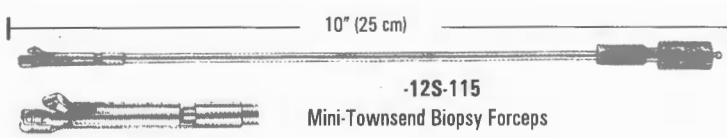

**-12S-115**  
Mini-Townsend Biopsy Forceps

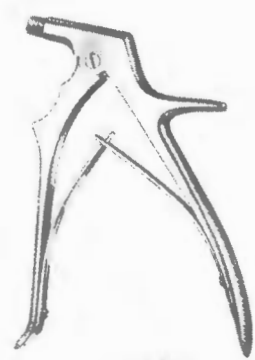

**-12S-116**  
Handle



12S

# GYNACOLOGICAL & OBSTETRICAL INSTRUMENTS

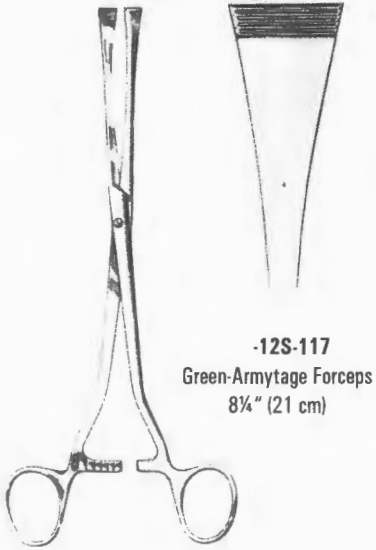

**-12S-117**  
Green-Armytage Forceps  
8 1/4" (21 cm)



**-12S-118**  
Sellheim Forceps  
11" (28 cm)

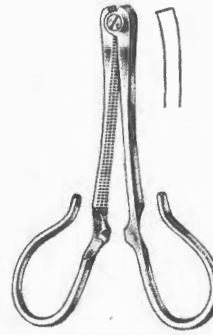

**-12S-119**  
Kane Clamps  
3 1/2" (8,5cm)



**-12S-120**  
Collin Clamps  
3 1/2" (9 cm)

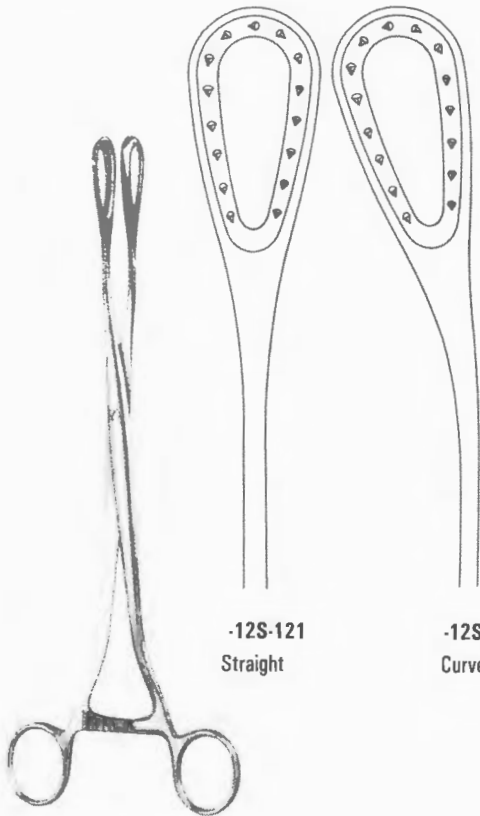

**Saenger Forceps**  
10 1/2" (27 cm)

**-12S-121**  
Straight

**-12S-122**  
Curved

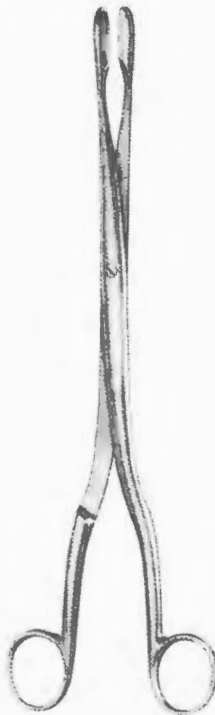

**Winter Forceps**  
11" (28 cm)



**-12S-123**  
Straight



**-12S-124**  
Curved



**-12S-125**  
Straight



**-12S-126**  
Curved

# GYNACOLOGICAL & OBSTETRICAL INSTRUMENTS



12S

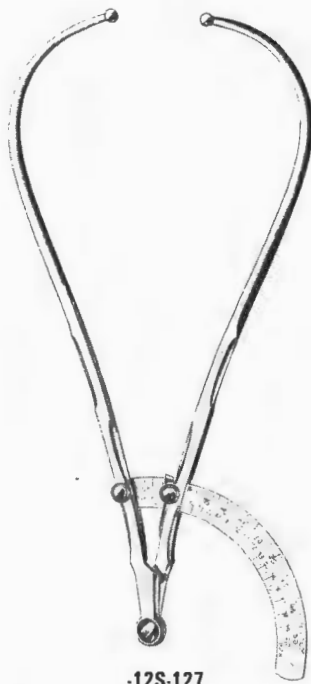

-12S-127  
Martin Pelvineter  
13½" (34 cm)

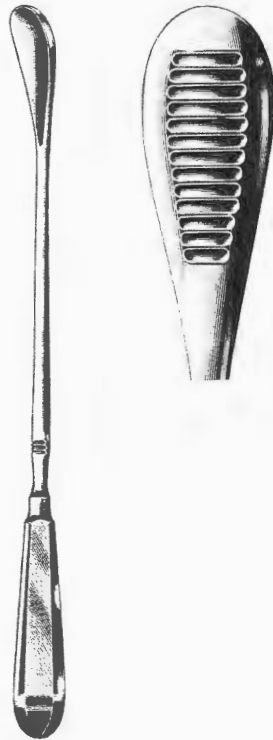

Cuzzi Spoon  
12" (30 cm)



-12S-128



-12S-129



-12S-130

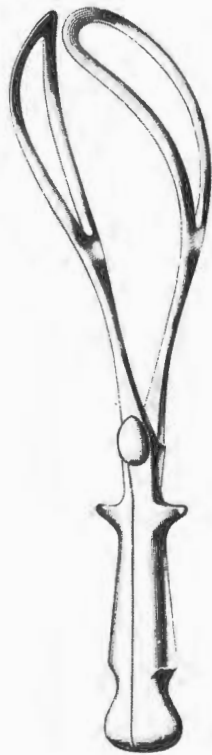

Naegele Obstetrical Forceps  
-12S-131 | 14" (36 cm)  
-12S-132 | 16" (40 cm)



-12S-133  
Simpson Obstetrical Forceps  
12" (30 cm)

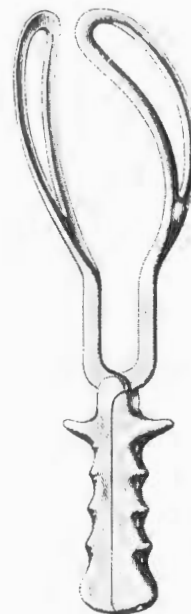

-12S-134  
Simpson-Braun Obstetrical Forceps  
14" (36 cm)

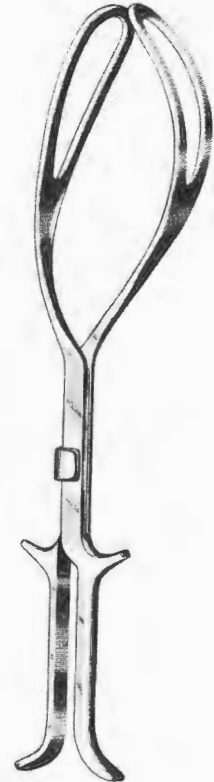

-12S-135  
Kielland Obstetrical Forceps  
16" (41 cm)

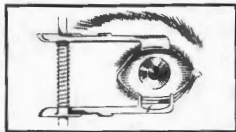

13S

# EYE INSTRUMENTS

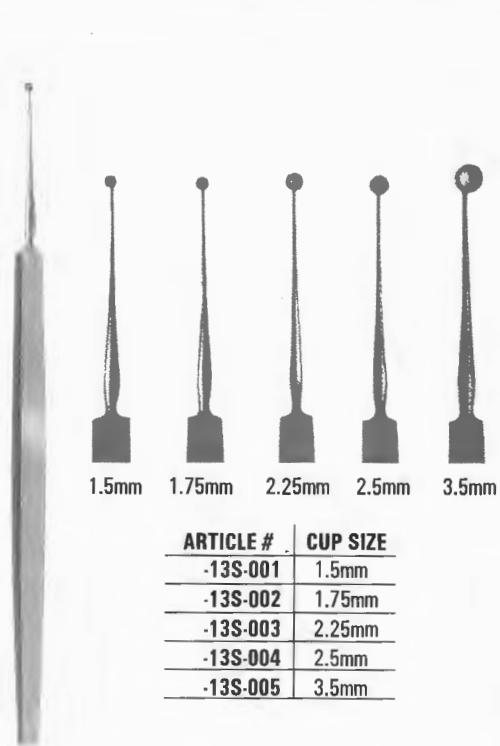

1.5mm 1.75mm 2.25mm 2.5mm 3.5mm

ARTICLE #	CUP SIZE
-13S-001	1.5mm
-13S-002	1.75mm
-13S-003	2.25mm
-13S-004	2.5mm
-13S-005	3.5mm

Meyerhoefer Curette



Desmarres Lid Retractor



-13S-007

-13S-009



-13S-006

-13S-008



-13S-010

Graefe Muscle Hook

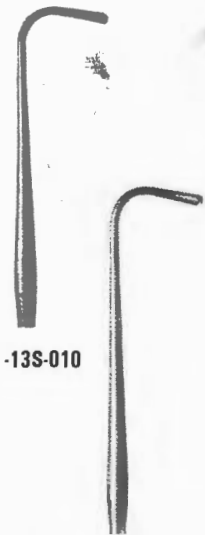

-13S-011



-13S-012

Jameson Muscle Hook small



-13S-013

Jameson Muscle Hook large



3 mm

-13S-014

Kansas Lens Loop



-13S-015

Wheeler Spatula 13cm



-13S-016

Castroviejo Spatula 0.5mm



# EYE INSTRUMENTS

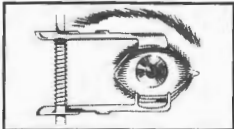

13S



**-13S-017**  
Barraquer Eye Speculum  
small



**-13S-018**  
Barraquer Eye Speculum  
large

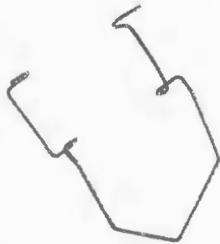

**-13S-019**  
Kratz-Barraquer Eye Speculum  
large

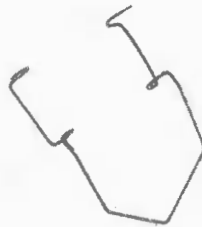

**-13S-020**  
Kratz-Barraquer Eye Speculum  
small



**-13S-021**  
Barraquer  
small



**-13S-022**  
Barraquer  
large



**-13S-023**  
Lieberman  
Eye Speculum, K-wire



**-13S-024**  
Lieberman  
Eye Speculum, V-wire



**-13S-025**  
Lieberman  
Eye Speculum, Pediatric  
Thin Solid Blade



**-13S-026**  
Lieberman  
Eye Speculum, Pediatric  
Thin Solid Blade



**-13S-026**  
Castroviejo Caliper



**-13S-027**  
Curved



**-13S-028**  
Angled



**-13S-029**  
Straight



**-13S-030**  
Stevenson Lacrimal  
Sac Retractor Solid Blade



**-13S-031**  
Stevenson Lacrimal  
Sac Retractor 3x3 Blunt Prong



**-13S-032**  
Jaeger Lid Plate  
Stainless Steel

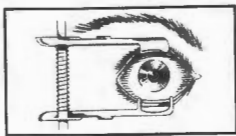

13S

# EYE INSTRUMENTS

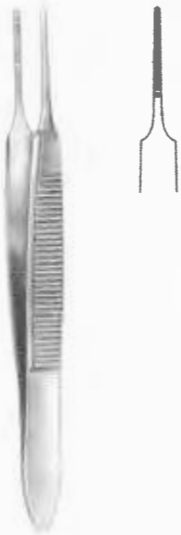

-13S-033  
Graefe Iris Forceps  
2 3/4" (7 cm)



-13S-034  
Graefe Iris Forceps  
2 3/4" (7 cm)



-13S-035  
Graefe 1:2 Iris Forceps  
2 3/4" (7 cm)



-13S-036  
Graefe 1:2 Iris Forceps  
2 3/4" (7 cm)



Graefe Iris Forceps  
4 1/2" (11 cm)



-13S-037

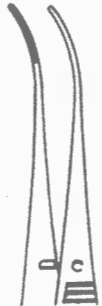

-13S-038



-13S-039



-13S-040



-13S-041



-13S-042



(Colibri) Iris Forceps  
2 3/4" (7 cm)



10x  
-13S-043



Troutman  
(Corneal) Iris Forceps  
3" (7.5cm)



10x  
-13S-044



Troutman  
(Colibri) Iris Forceps  
2 3/4" (7 cm)



10x  
-13S-045

# EYE INSTRUMENTS

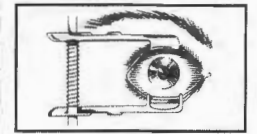

13S



-13S-046

Bishop-Hartman Forceps  
3 1/2" (8.5cm)



-13S-047

Bishop-Hartman Forceps  
3 1/2" (8.5cm)



-13S-048

Bishop-Hartman Forceps  
3 1/2" (8.5cm)



-13S-049

Bishop-Hartman Forceps  
3 1/2" (8.5cm)



10x



10x

-13S-050

Kirby Forceps  
3 1/2" (9 cm)



-13S-051

Erhardt Chalazion Forceps  
3 1/2" (9 cm)



-13S-052

Ayer Chalazion Forceps  
3 1/2" (9 cm)



-13S-053

Ayer Chalazion Forceps  
3 1/2" (9 cm)

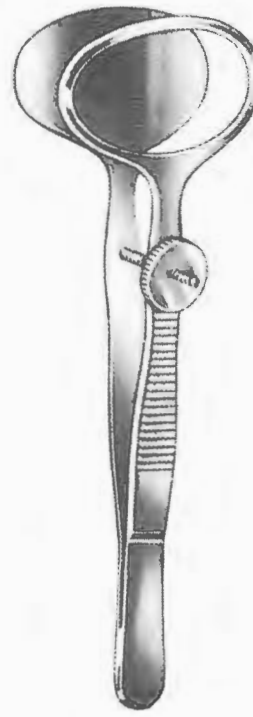

-13S-054 - -13S-056

Desmarres Chalazion Forceps  
3 1/2" (9 cm)



-13S-054

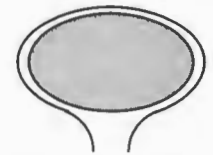

-13S-055



-13S-056

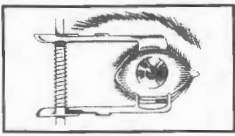

13S

# EYE INSTRUMENTS



-13S-057  
Graefe Fixation Forceps  
4" (10 cm)



Castroviejo 1:2  
Fixation Forceps  
4" (10 cm)

ARTICLE #	1x2 T Width
-13S-058	0.12mm
-13S-059	0.30mm
-13S-060	0.50mm
-13S-061	1.00mm
-13S-062	1.50mm

Castroviejo 1:2  
Fixation Forceps  
3½" (9 cm)



Straight



-13S-063

Curved



-13S-064



-13S-065  
Elsching 1:2 Fixation Forceps  
4½" (11 cm)



-13S-066  
Paufigue 1:2 Suture Forceps  
4" (10 cm)

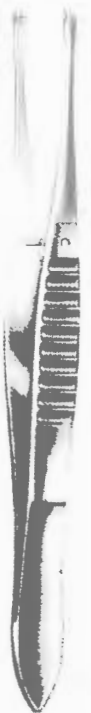

-13S-067  
Elsching 2:3 Fixation Forceps  
4½" (11 cm)



-13S-068  
Elsching 3:4 Fixation Forceps  
4½" (11 cm)



1:2  
-13S-069



2:3  
-13S-070

Lester Fixation Forceps  
3½" (9 cm)



-13S-071  
Moorfield Fixation Forceps  
4" (10 cm)

# EYE INSTRUMENTS

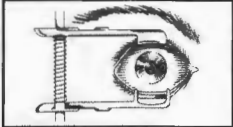

13S

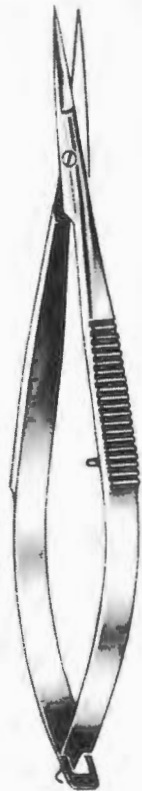

-13S-072

-13S-073

-13S-074

**-13S-072 - -13S-074**  
Noyes Iris Scissors  
4¾" (12 cm)

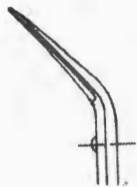
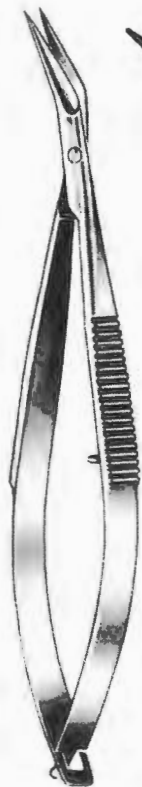

**-13S-075**  
Noyes Iris Scissors  
4¾" (12 cm)



**Wecker Scissors**  
4½" (11 cm)



-13S-076



-13S-077



-13S-078



**-13S-079**  
Barraquer Scissors  
2½" (5.5cm)



-13S-080



-13S-081



-13S-082



-13S-083

**Castroviejo Scissors**  
3½" (9 cm)

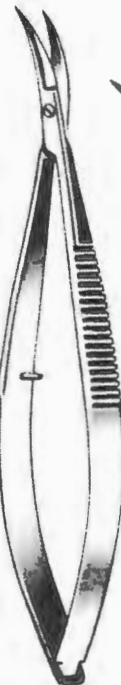

**-13S-084**  
Castroviejo Scissors  
4" (10 cm)

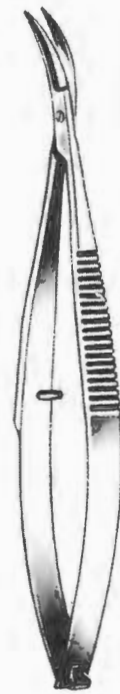

**-13S-085**  
Castroviejo Scissors  
4" (10 cm)

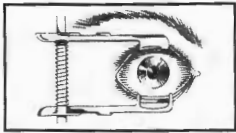

13S

# EYE INSTRUMENTS

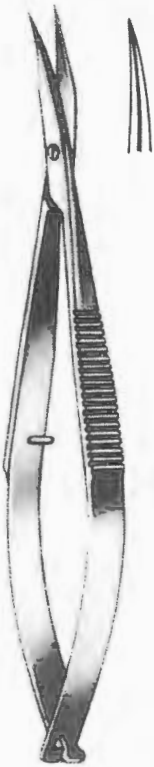

**-13S-086**  
Westcott Tenotomy Scissors  
4½" (11 cm)

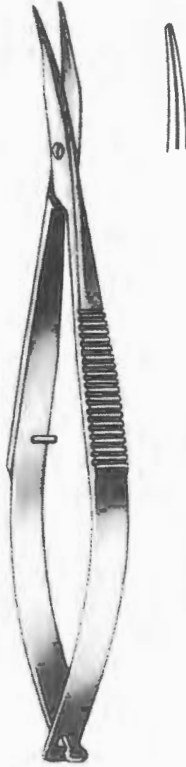

**-13S-087**  
Westcott Tenotomy Scissors  
4½" (11 cm)



**-13S-088**  
Castroviejo Corneal Scissors  
4" (10 cm)

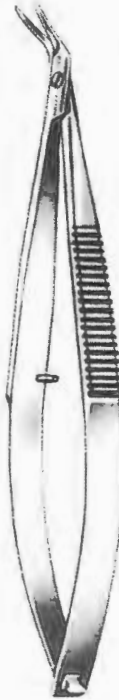

**-13S-089**  
Castroviejo Corneal Scissors  
4" (10 cm)

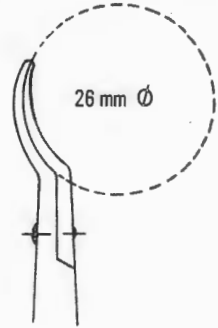

**-13S-090**  
Castroviejo Corneal Scissors  
4½" (11 cm)

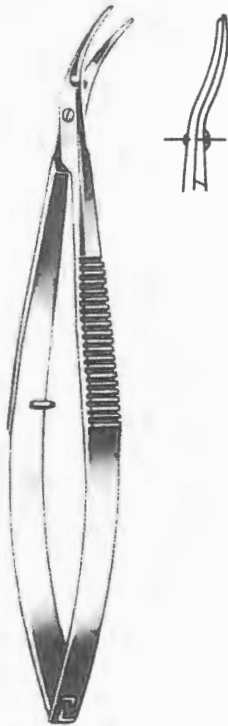

**-13S-091**  
Castroviejo Corneal Scissors  
4½" (11 cm)

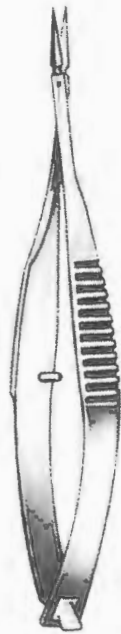

**-13S-092**  
Vannas Scissors  
Straight, 3½" (8.5cm)

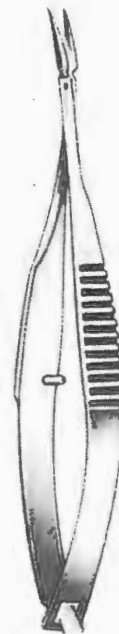

**-13S-093**  
Vannas Scissors  
Curved, 3½" (8.5cm)

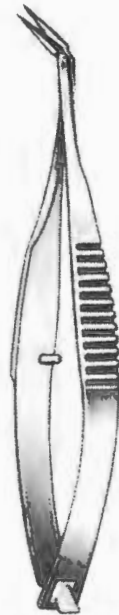

**-13S-094**  
Vannas Scissors  
Angled, 3½" (8.5cm)

# EYE INSTRUMENTS

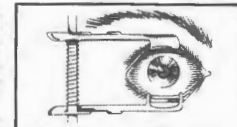

13S

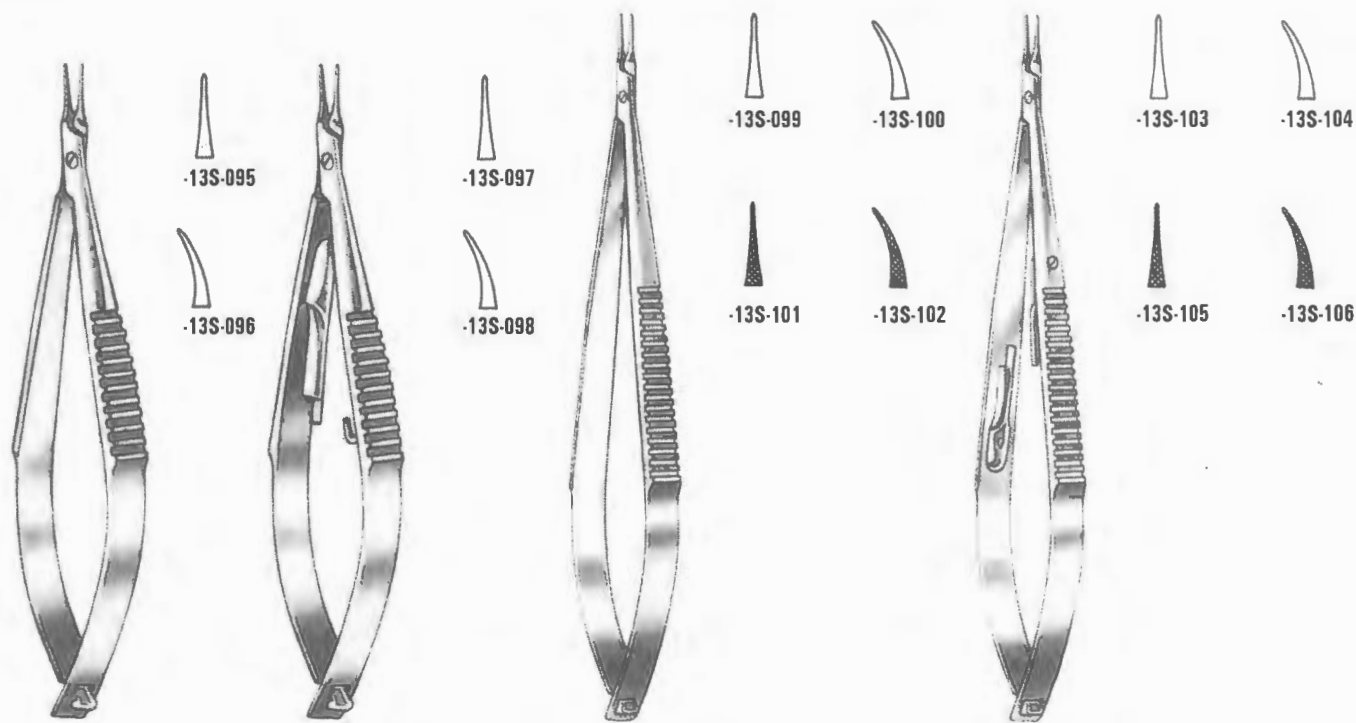

Castroviejo Needle Holders  
3 1/2" (9 cm)

Castroviejo Needle Holders  
3 1/2" (9 cm)

Castroviejo Needle Holders  
5 1/2" (14 cm)

Castroviejo Needle Holders  
5 1/2" (14 cm)

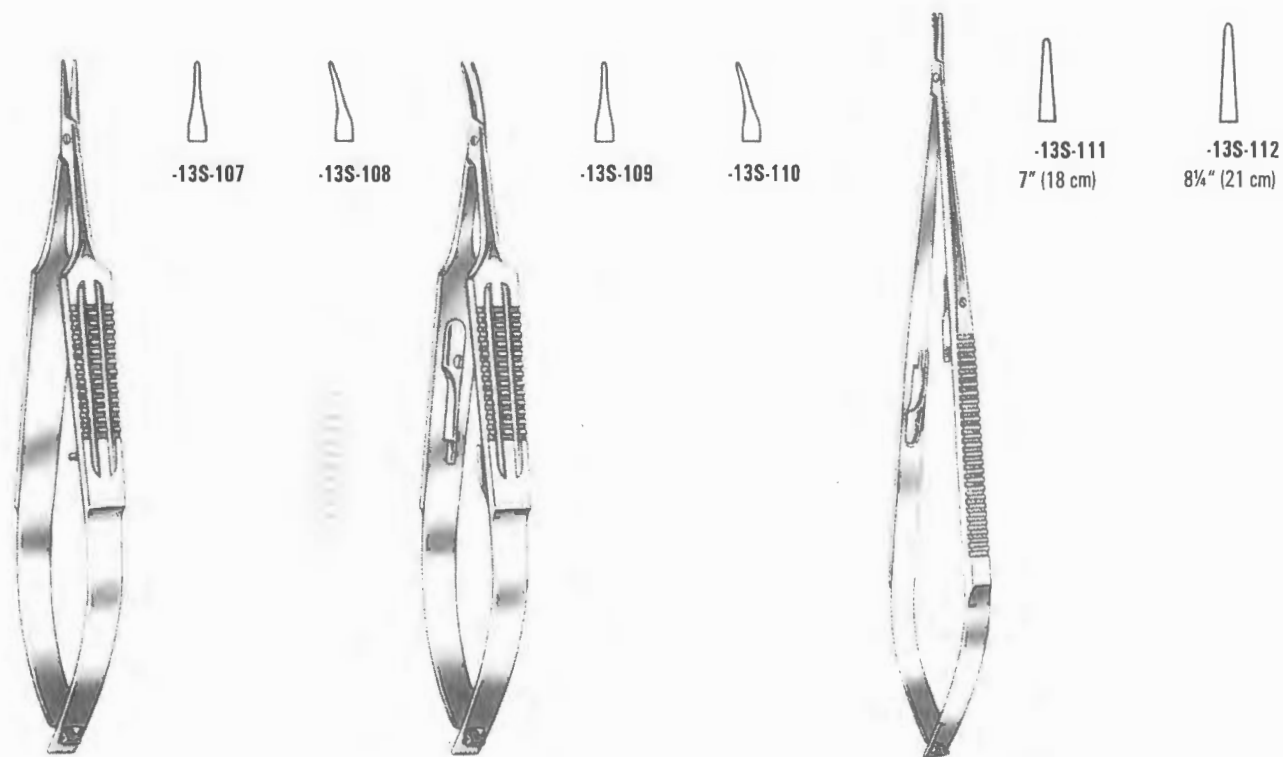

Castroviejo Needle Holders  
5 1/2" (14 cm)

Castroviejo Needle Holders  
5 1/2" (14 cm)

Jacobson Needle Holders

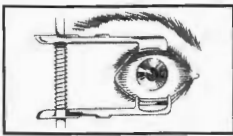

13S

# EYE INSTRUMENTS

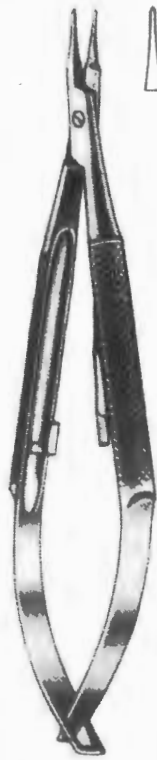

**-13S-113**  
Barraquer-Troutman  
Needle Holder  
4" (10 cm)

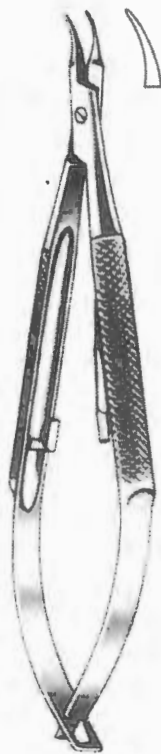

**-13S-114**  
Barraquer-Troutman  
Needle Holder  
4" (10 cm)

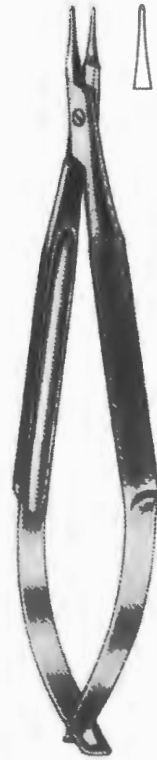

**-13S-115**  
Barraquer-Troutman  
Needle Holder  
4" (10 cm)



**-13S-116**  
Barraquer-Troutman  
Needle Holder  
4" (10 cm)



**-13S-117**  
Barraquer Needle Holder  
4 1/4" (11 cm)

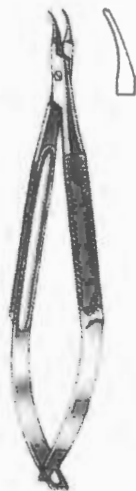

**-13S-118**  
Barraquer Needle Holder  
5" (13 cm)

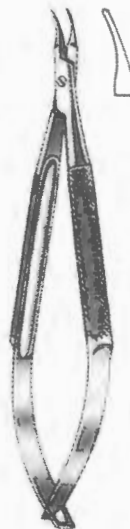

**-13S-119**  
Barraquer Needle Holder  
5 1/2" (14 cm)

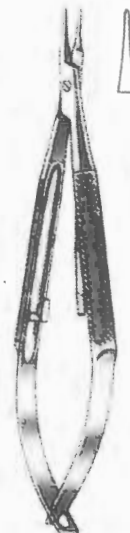

**-13S-120**  
Barraquer Needle Holder  
5 1/2" (14 cm)

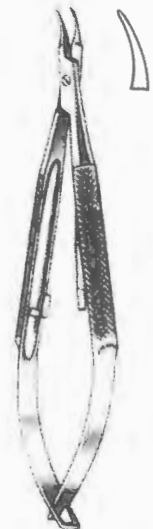

**-13S-121**  
Barraquer Needle Holder  
5 1/2" (14 cm)



# EYE INSTRUMENTS

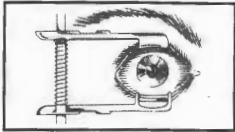

**13S**

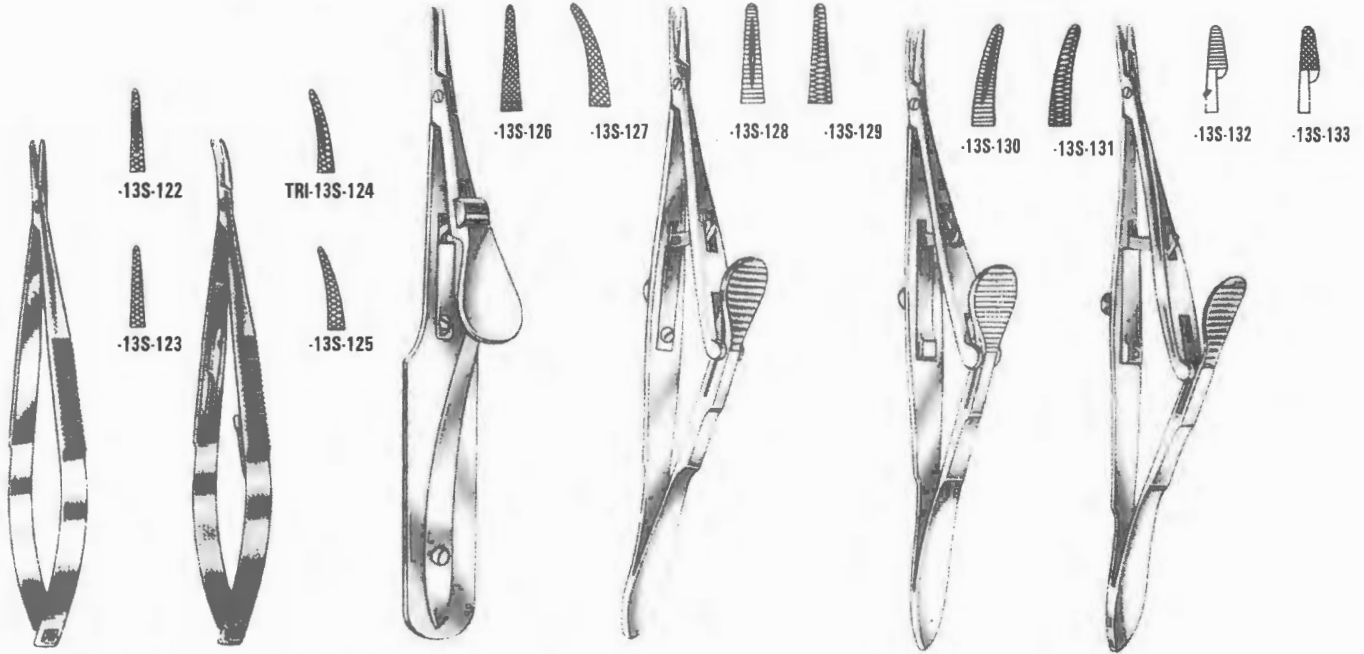

**Paton Needle Holder**  
4½" (11 cm)

**Paton Needle Holder**  
4½" (11 cm)

**Arruga Needle Holder**  
5½" (14 cm)

**Kalt Needle Holder**  
5½" (14 cm)

**Kalt-Arruga Needle Holder**  
5½" (14 cm)

**Castroviejo-Kalt Needle Holder**  
5¼" (13.5cm)



**Stevens Needle Holder**

**TRI-13S-136**  
**Potts-Smith**  
**Needle Holder**  
8¼" (22 cm)

**Castroviejo Blade Breaker**  
5¼" (13 cm)

**Castroviejo Blade Breaker**  
5¼" (13 cm)

**Castroviejo Blade Breaker**  
5¼" (13 cm)

**Castroviejo Blade Breaker**  
5¼" (13 cm)

ARTICLE #	SIZE
-13S-134	5" (13 cm)
-13S-135	6" (15 cm)



14S

# ATRAUMATIC INSTRUMENTS

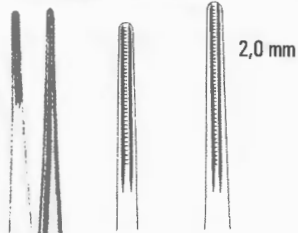

-14S-001 6 1/4" (16 cm)  
-14S-002 8" (20 cm)

-14S-003 9 1/4" (24 cm)  
-14S-004 12" (30 cm)

De-Bakey Trauma Dressing Forceps

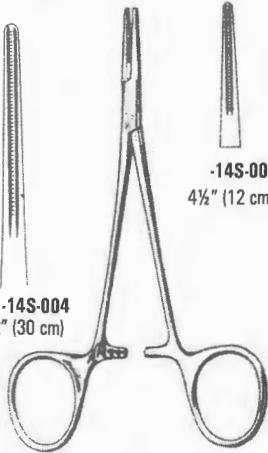

De-Bakey-Mosquito

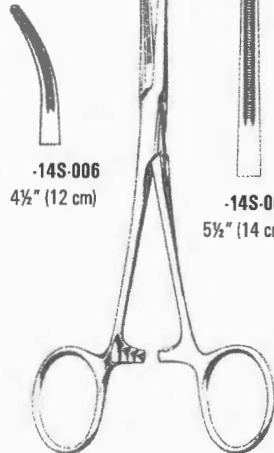

De-Bakey-Kelly

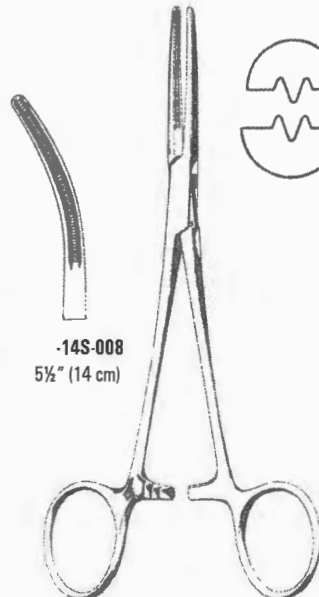

De-Bakey-Rankin

-14S-005 4 1/2" (12 cm)  
-14S-006 4 1/2" (12 cm)

-14S-007 5 1/2" (14 cm)  
-14S-008 5 1/2" (14 cm)

-14S-009 6 1/4" (16 cm)  
-14S-010 6 1/4" (16 cm)

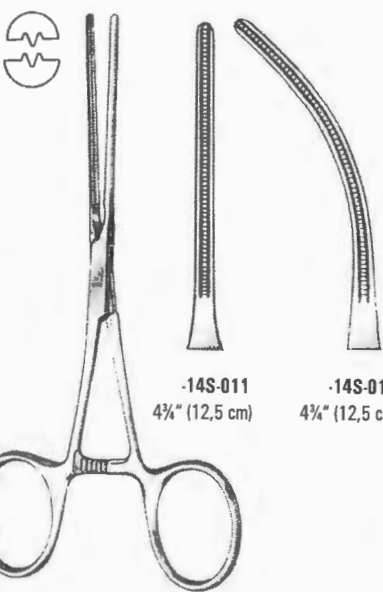

De-Bakey-Atraumatic Vascular Clamps

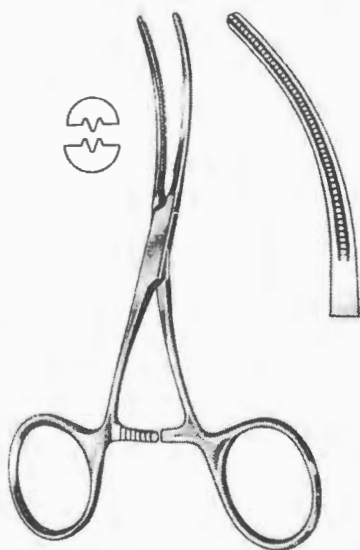

-14S-013  
De-Bakey-Atraumatic Vascular Clamps  
4 1/4" (12,5 cm)

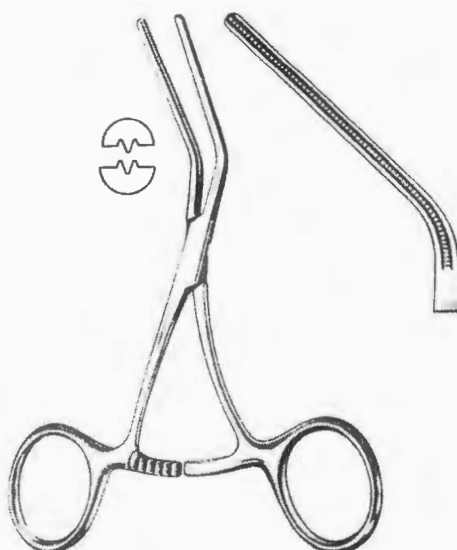

-14S-014  
De-Bakey-Atraumatic Vascular Clamps  
4 1/4" (12,5 cm)

# ATRAUMATIC INSTRUMENTS

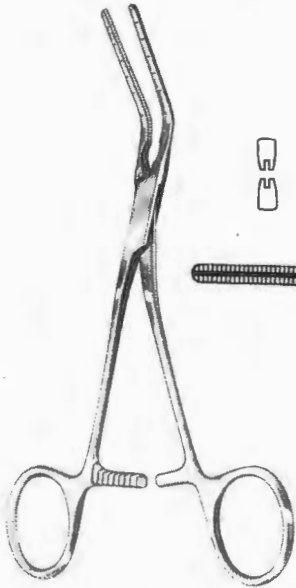

**Cooley**  
Atraumatic Vascular Clamps

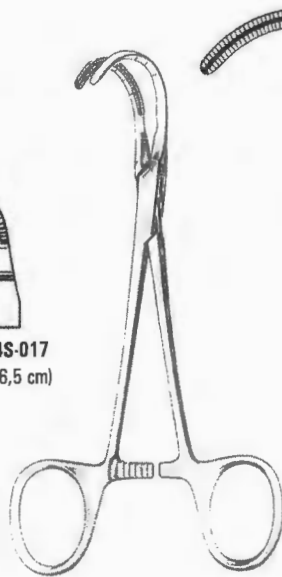
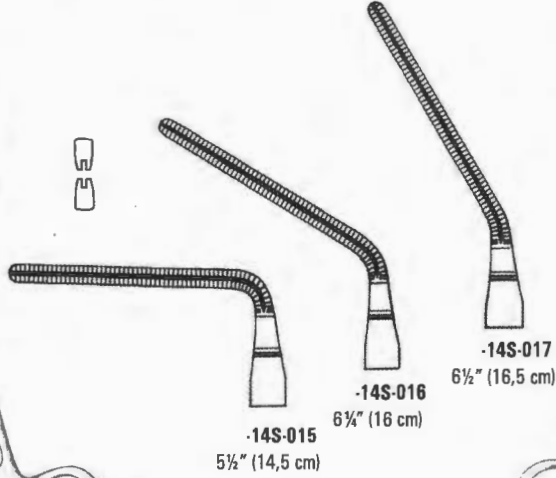

**Cooley-Beck**  
Atraumatic Vascular Clamps

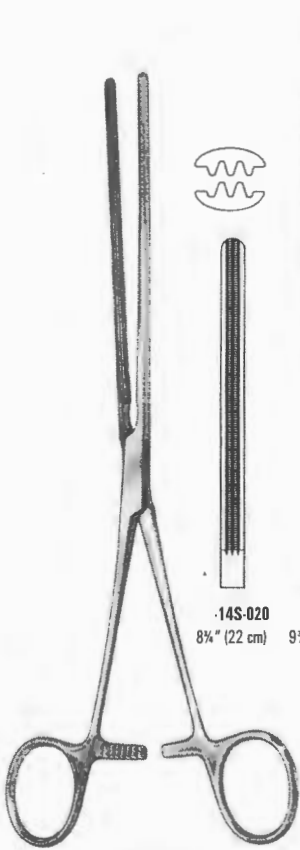
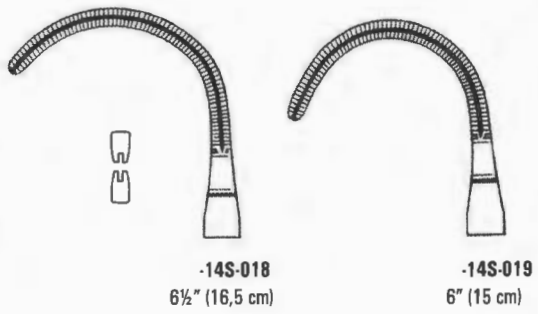

**De-Bakey**  
Atraumatic Intestinal Clamps

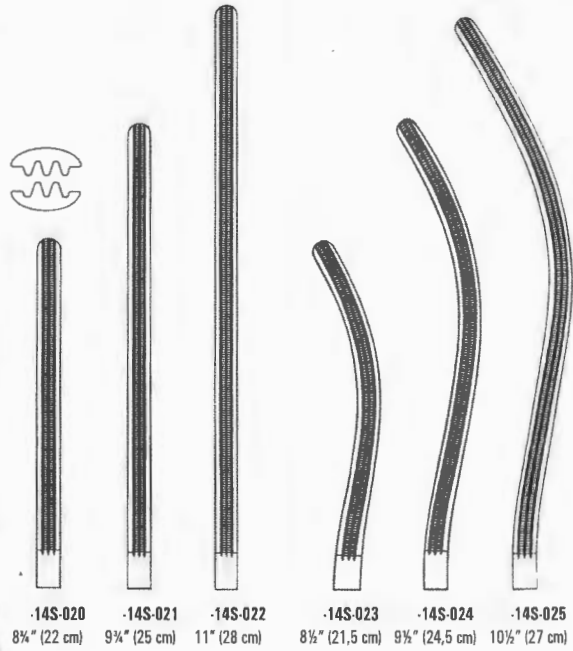

**Cooley**  
Atraumatic Vascular Clamps

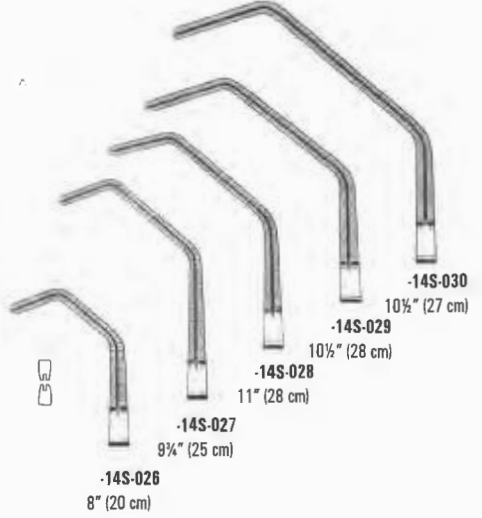

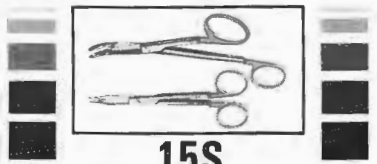

**TUNGSTEN CARBIDE INSTRUMENTS  
(T.C)**

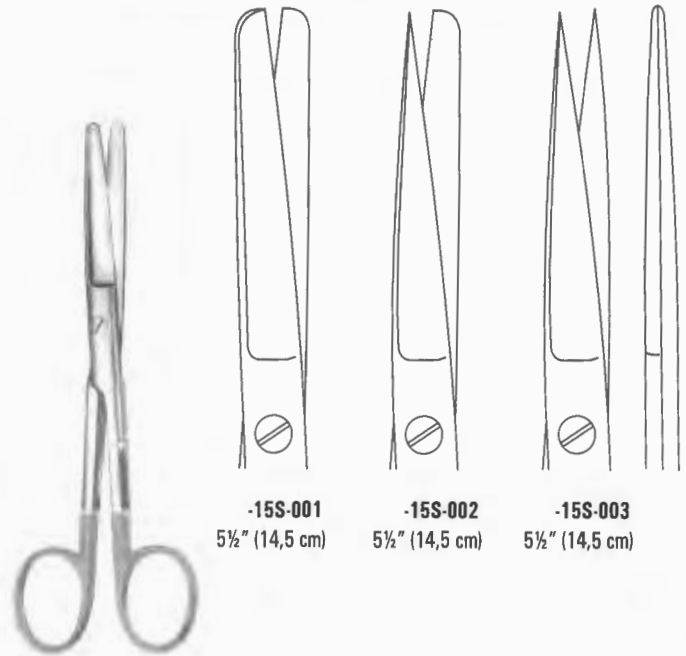

- 15S-001  
5½" (14,5 cm)
- 15S-002  
5½" (14,5 cm)
- 15S-003  
5½" (14,5 cm)

Dressing Scissors, Straight T.C



- 15S-004  
5½" (14,5 cm)
- 15S-005  
5½" (14,5 cm)
- 15S-006  
5½" (14,5 cm)

Dressing Scissors, Curved T.C

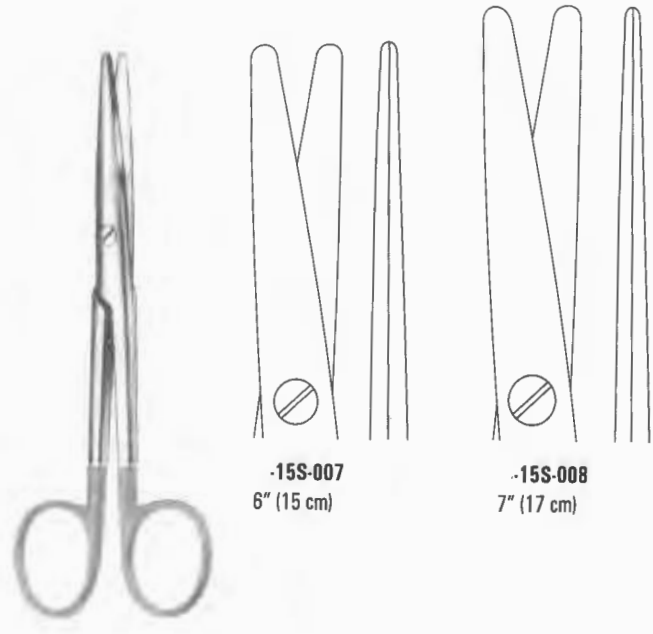

- 15S-007  
6" (15 cm)
- 15S-008  
7" (17 cm)

Mayo Stille Scissors, Straight T.C

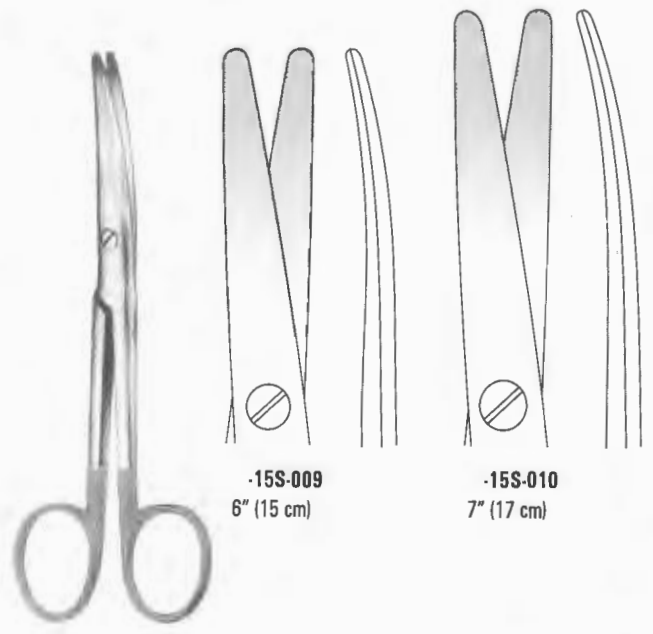

- 15S-009  
6" (15 cm)
- 15S-010  
7" (17 cm)

Mayo Stille Scissors, Curved T.C

**TUNGSTEN CARBIDE INSTRUMENTS  
(T.C)**

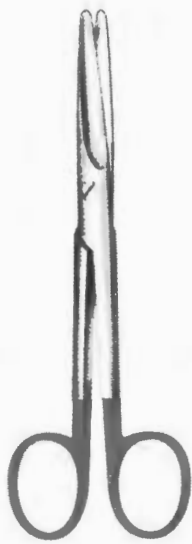
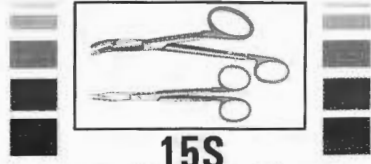

Mayo Scissors, Straight T.C



-15S-011  
5½" (14 cm)

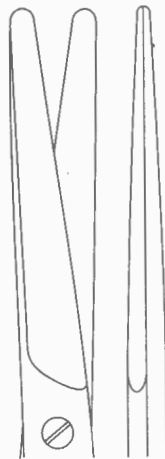

-15S-012  
7" (17 cm)

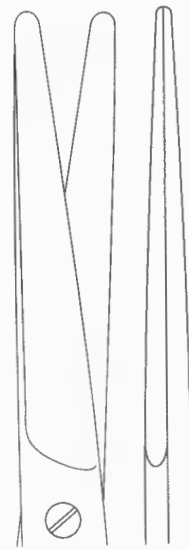

-15S-013  
9" (23 cm)

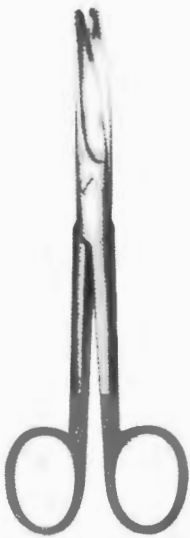

Mayo Scissors, Curved T.C



-15S-014  
5½" (14 cm)



-15S-015  
7" (17 cm)



-15S-016  
9" (23 cm)

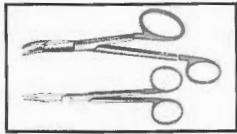

15S

# TUNGSTEN CARBIDE INSTRUMENTS (T.C)



Metzenbaum Scissors  
Straight T.C

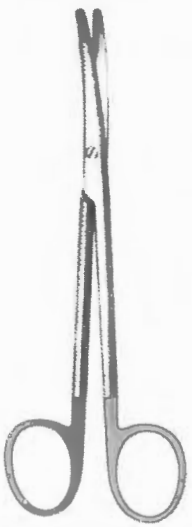
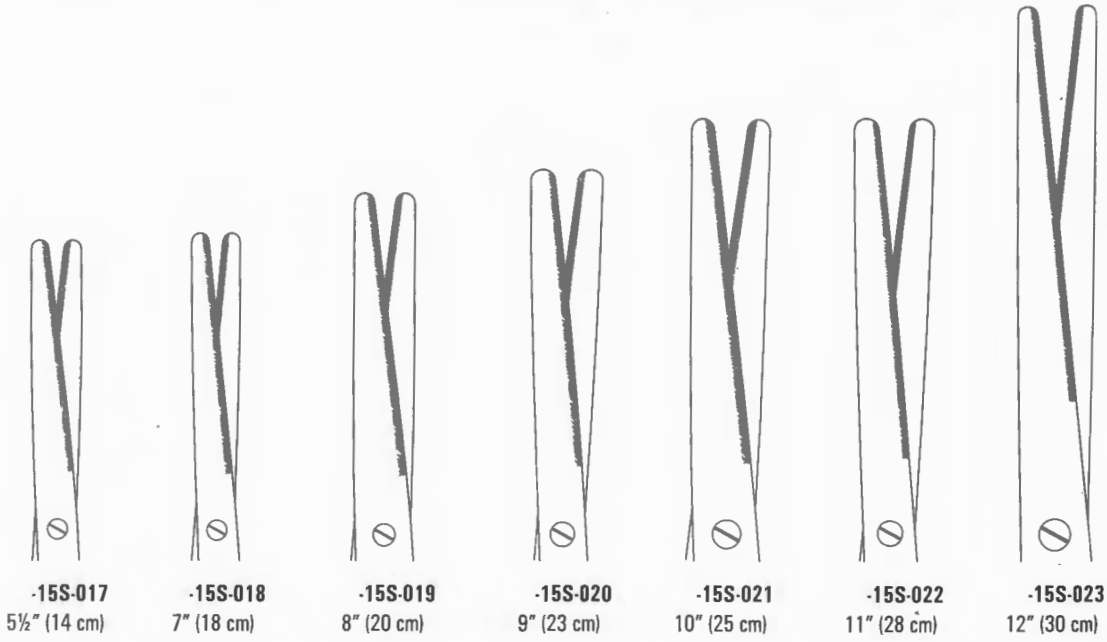

Metzenbaum Scissors  
Curved T.C

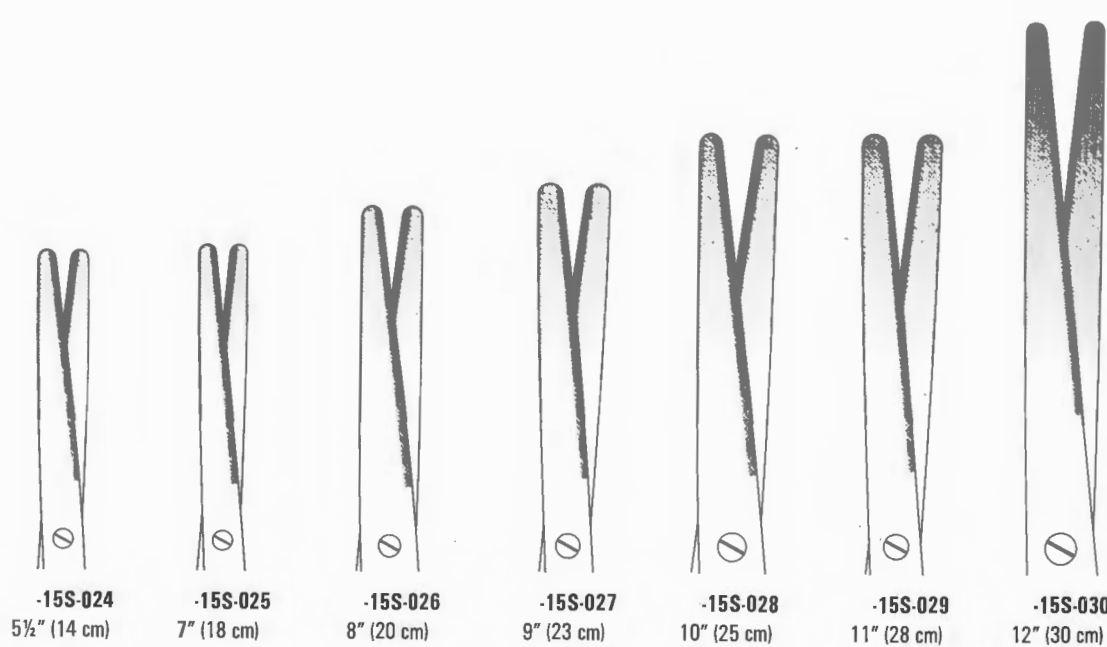

# TUNGSTEN CARBIDE INSTRUMENTS (T.C)

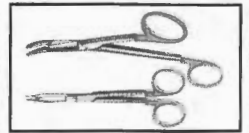

**15S**

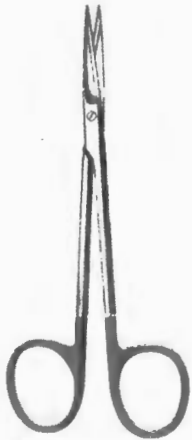

**Iris Scissors T.C**

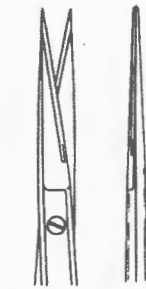

**-15S-031**  
4½" (11 cm)

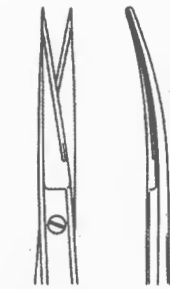

**-15S-032**  
4½" (11 cm)

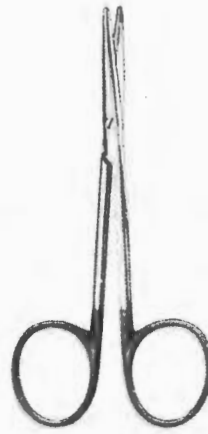

**Strabismus Scissors T.C**



**-15S-033**  
4½" (11 cm)

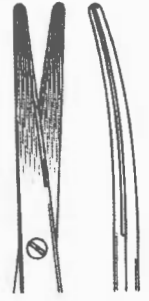

**-15S-034**  
4½" (11 cm)

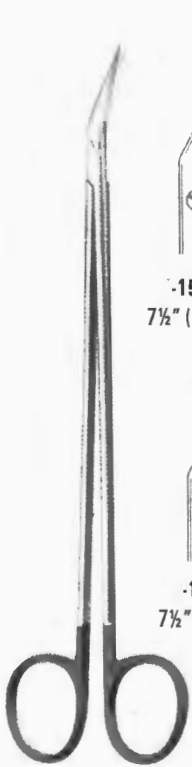

**Potts Smith Scissors T.C**



**-15S-035**  
7½" (19 cm)

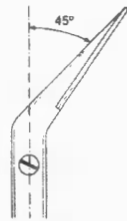

**-15S-036**  
7½" (19 cm)

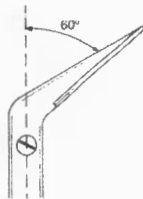

**-15S-037**  
7½" (19 cm)

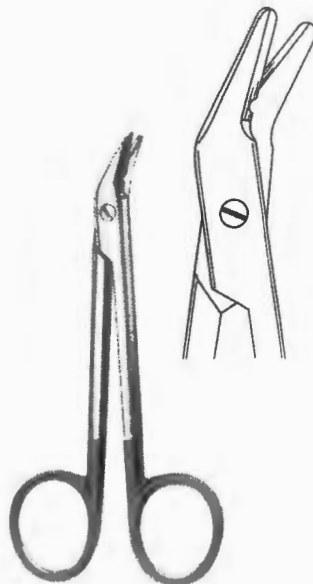

**-15S-038**  
**Wire Cutter Universal T.C**  
4¾" (12 cm)



**Tenotomy Scissors T.C**



**-15S-039**  
5" (13 cm)

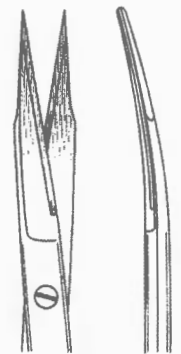

**-15S-040**  
5" (13 cm)

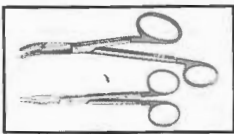

15S

# TUNGSTEN CARBIDE INSTRUMENTS (T.C)

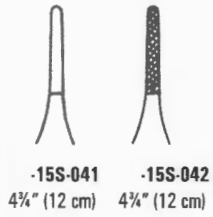

**-15S-041**  
4 3/4" (12 cm)

**-15S-042**  
4 3/4" (12 cm)

Adson Forceps T.C



ARTICLE #	LENGTH
-15S-043	4 3/4" (12 cm)
-15S-044	6" (15 cm)

Adson-Brown T.C

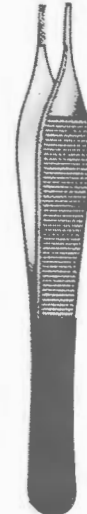

1 x 2

ARTICLE #	LENGTH	JAW
-15S-045	4 3/4" (12 cm)	1,7 mm
-15S-046	4 3/4" (12 cm)	1,0 mm
-15S-047	6" (15 cm)	1,7 mm
-15S-048	6" (15 cm)	1,0 mm

Micro-Adson T.C



Wangensteen Forceps T.C

ARTICLE #	LENGTH
-15S-049	6" (15 cm)
-15S-050	9" (23 cm)
-15S-051	9 3/4" (25 cm)



**-15S-052**  
McIndoe Forceps T.C  
6" (15 cm)



Bayonet Forceps T.C

ARTICLE #	LENGTH
-15S-053	5 1/2" (14 cm)
-15S-054	6 1/2" (16 cm)



# TUNGSTEN CARBIDE INSTRUMENTS (T.C)

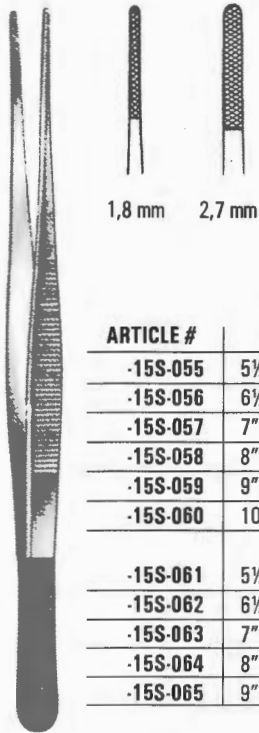
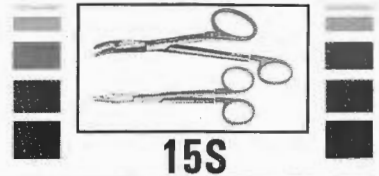

ARTICLE #	LENGTH	JAW
-15S-055	5½" (14,5 cm)	1,8 mm
-15S-056	6½" (16 cm)	1,8 mm
-15S-057	7" (18 cm)	1,8 mm
-15S-058	8" (20 cm)	1,8 mm
-15S-059	9" (23 cm)	1,8 mm
-15S-060	10" (25 cm)	1,8 mm
-15S-061	5½" (14,5 cm)	2,7 mm
-15S-062	6½" (16 cm)	2,7 mm
-15S-063	7" (18 cm)	2,7 mm
-15S-064	8" (20 cm)	2,7 mm
-15S-065	9" (23 cm)	2,7 mm

Dressing Forceps T.C



With Dissector:

ARTICLE #	LENGTH
-15S-066	7" (18 cm)
-15S-067	8¼" (21 cm)
-15S-068	9" (23 cm)
-15S-069	10" (25 cm)

Potts-Smith  
Dressing Forceps T.C

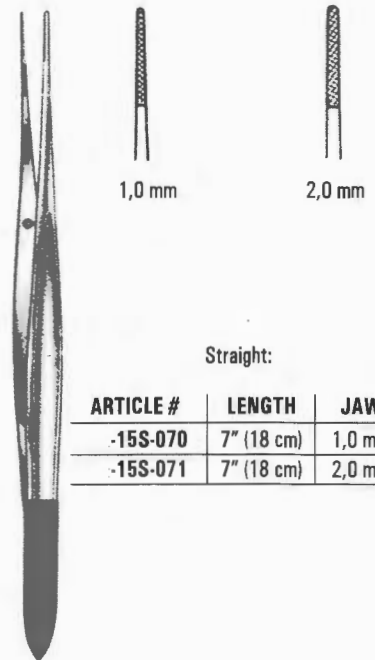

Straight:

ARTICLE #	LENGTH	JAW
-15S-070	7" (18 cm)	1,0 mm
-15S-071	7" (18 cm)	2,0 mm

Cushing Dressing Forceps T.C

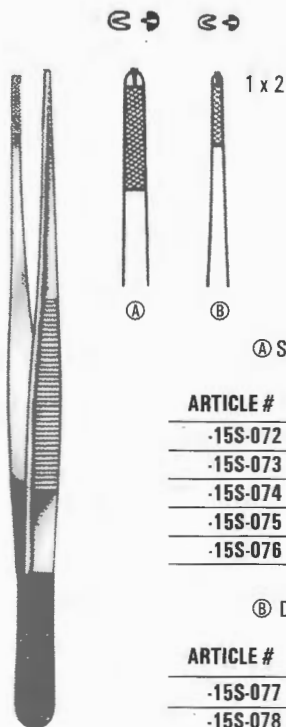

Ⓐ Standard:

ARTICLE #	LENGTH
-15S-072	5½" (14,5 cm)
-15S-073	6½" (16 cm)
-15S-074	7" (18 cm)
-15S-075	8" (20 cm)
-15S-076	10" (25 cm)

Ⓑ Delicate:

ARTICLE #	LENGTH
-15S-077	5½" (14,5 cm)
-15S-078	6½" (16 cm)
-15S-079	7" (18 cm)
-15S-080	8" (20 cm)
-15S-081	10" (25 cm)

Oehler  
Tissue Forceps T.C

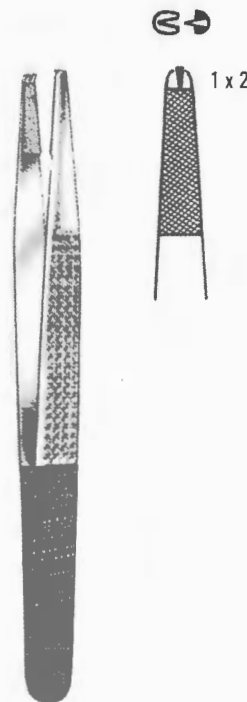

-15S-082  
Bonney Tissue Forceps T.C  
6¼" (17 cm)

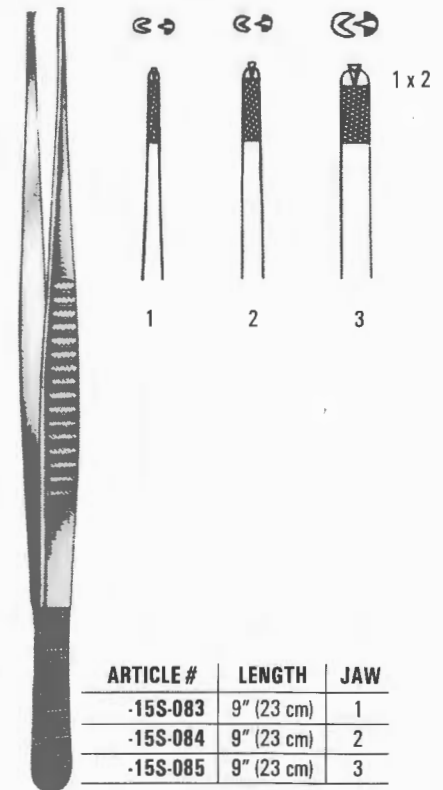

ARTICLE #	LENGTH	JAW
-15S-083	9" (23 cm)	1
-15S-084	9" (23 cm)	2
-15S-085	9" (23 cm)	3

Skinner Tissue Forceps T.C

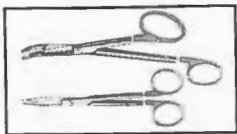

15S

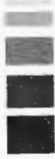

# TUNGSTEN CARBIDE INSTRUMENTS (T.C)



**-15S-086**  
Williams Tissue Forceps T.C  
8" (20 cm)

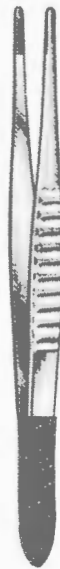

**-15S-087**  
Mod. USA, Dressing Forceps T.C  
8" (15 cm)



**-15S-088**  
Gillies Tissue Forceps T.C  
6" (15 cm)



**-15S-089**  
Gerald Dressing Forceps T.C  
7" (18 cm)

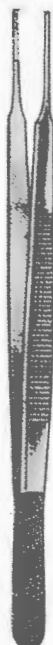

**-15S-090**  
Gerald Tissue Forceps T.C  
7" (18 cm)



**-15S-091**  
Evans Tissue Forceps T.C  
9 1/4" (25 cm)

# TUNGSTEN CARBIDE INSTRUMENTS (T.C)

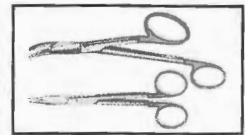

**15S**



**-15S-092**  
Derf Needle Holder T.C  
4 1/4" (12 cm)

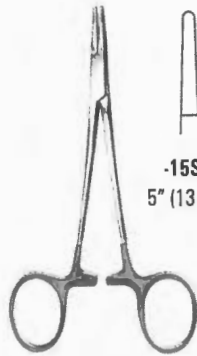

**-15S-093**  
5" (13 cm)  
Halsey Needle Holder T.C



**-15S-094**  
5" (13 cm)



**-15S-095**  
5" (13 cm)  
Webster Needle Holder T.C

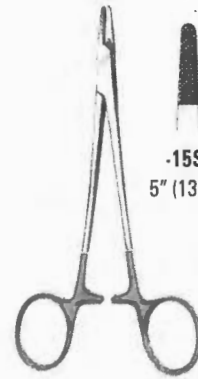

**-15S-096**  
5" (13 cm)  
**-15S-097**  
5 1/2" (14 cm)

Hegar-Baumgartner  
Needle Holder T.C

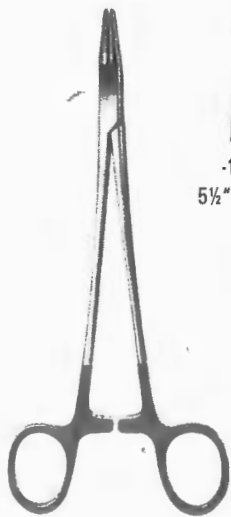

Mayo-Hegar Needle Holder T.C



**-15S-098**  
5 1/2" (14 cm)



**-15S-099**  
6 1/4" (16 cm)



**-15S-100**  
7" (18 cm)



**-15S-101**  
8" (20 cm)



**-15S-105**  
6" (15 cm)



**-15S-106**  
7" (18 cm)



**-15S-107**  
8" (20 cm)



**-15S-108**  
9" (23 cm)



**-15S-102**  
9 1/2" (24 cm)



**-15S-103**  
10" (26 cm)



**-15S-104**  
12" (30 cm)



Crile-Wood Needle Holder T.C



**-15S-109**  
10" (26 cm)



**-15S-110**  
12" (30 cm)

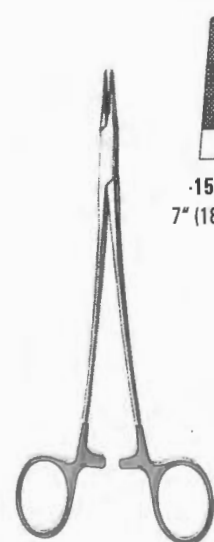

De-Bakey Needle Holder T.C



**-15S-111**  
7" (18 cm)



**-15S-112**  
8" (20 cm)



**-15S-113**  
9" (23 cm)



**-15S-114**  
10" (26 cm)



**-15S-115**  
12" (30 cm)

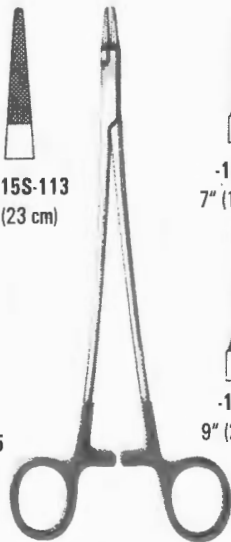

Intracardiac Needle Holder T.C



**-15S-116**  
7" (18 cm)



**-15S-117**  
8" (20 cm)



**-15S-118**  
9" (23 cm)



**-15S-119**  
10" (26 cm)

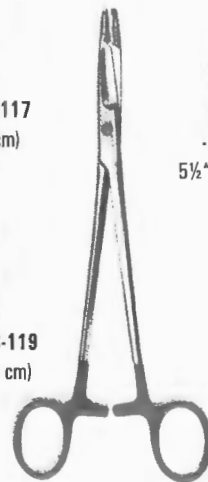

Olsen-Hegar Needle Holder T.C



**-15S-120**  
5 1/2" (14 cm)



**-15S-121**  
6 1/2" (16,5 cm)



**-15S-122**  
7" (18 cm)

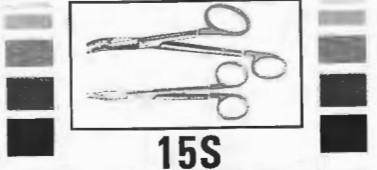

**TUNGSTEN CARBIDE INSTRUMENTS  
(T.C)**

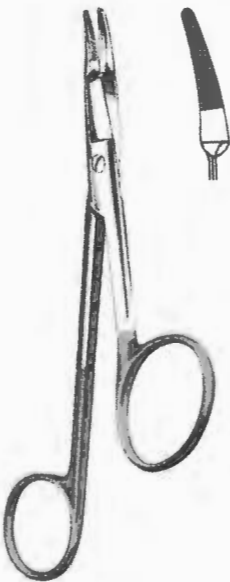

**-15S-123**  
Gillies Needle Holder T.C  
6½" (16 cm)

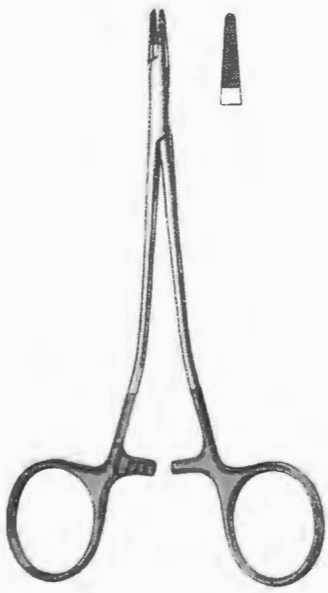

**-15S-124**  
Swedish Needle Holder T.C  
5½" (14,5 cm)

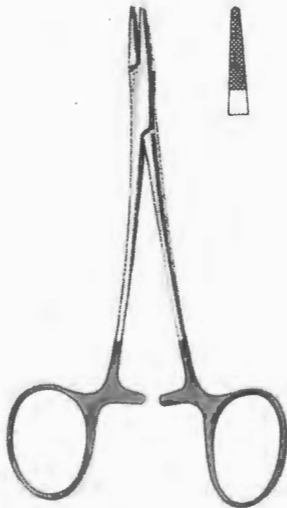

**-15S-125**  
Neivert Needle Holder T.C  
5" (13 cm)

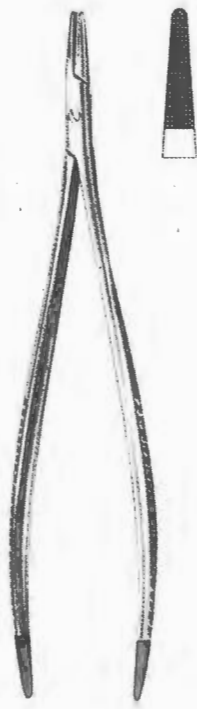

**-15S-126**  
Tonnies Needle Holder T.C  
7½" (19 cm)

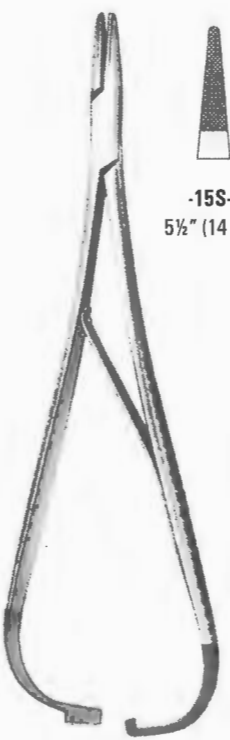

**-15S-127**  
5½" (14 cm)



**-15S-128**  
6¾" (17 cm)



**-15S-129**  
8" (20 cm)

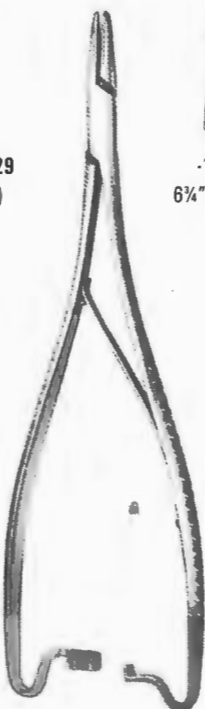

**-15S-130**  
6¾" (17 cm)



**-15S-131**  
8" (20 cm)



**-15S-132**  
9" (23 cm)

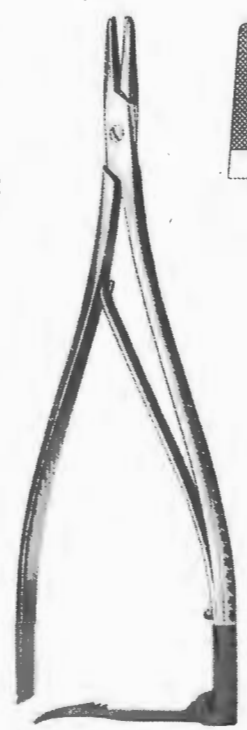

**-15S-133**  
Zweifel Needle Holder T.C  
8" (20 cm)











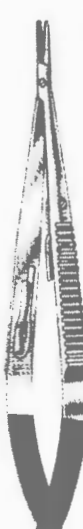



Mathieu Needle Holder T.C

Mathieu Needle Holder T.C

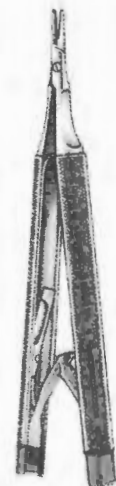
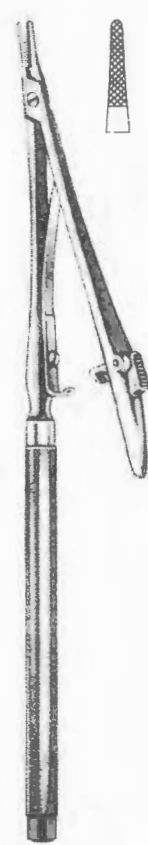
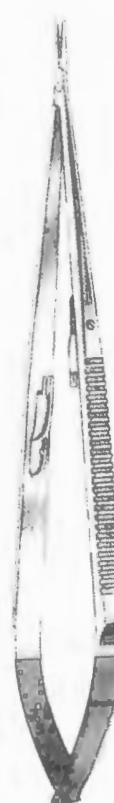
# TUNGSTEN CARBIDE INSTRUMENTS (T.C)

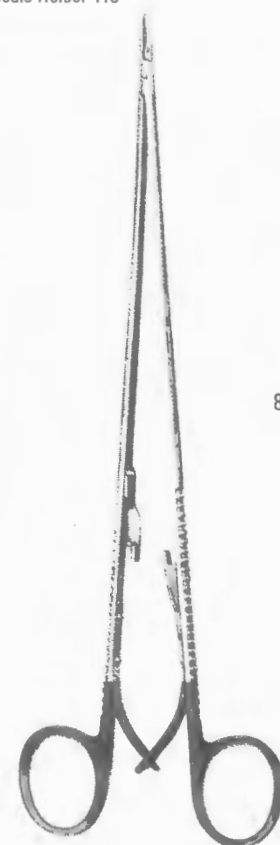

**15S**

 <b>-15S-134</b> 5½" (14 cm)	 <b>-15S-135</b> 5½" (14 cm)	 <b>-15S-136</b> 5½" (14 cm)	 <b>-15S-137</b> 5½" (14 cm)	 <b>-15S-138</b> 7" (18 cm)	 <b>-15S-139</b> 7" (18 cm)	 <b>-15S-140</b> 7" (18 cm)	 <b>-15S-141</b> 7" (18 cm)	 <b>-15S-142</b> Kalt Needle Holder T.C 5¼" (13,5 cm)
 <b>-15S-143</b> Castroviejo Blade Breaker 5¼" (13 cm)	 <b>-15S-144</b> Potts-Smith Blade Breaker 8¾" (22 cm)	 <b>-15S-145</b> 8¾" (21 cm)	 <b>-15S-146</b> 8¾" (21 cm)	 <b>-15S-147</b> 6¾" (16 cm)	 <b>-15S-148</b> 7" (18 cm)	 <b>-15S-149</b> 8" (20 cm)	 <b>-15S-150</b> 9" (23 cm)	 <b>-15S-151</b> 10¼" (26 cm)

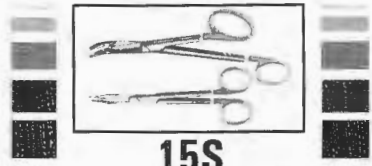

# TUNGSTEN CARBIDE INSTRUMENTS (T.C)

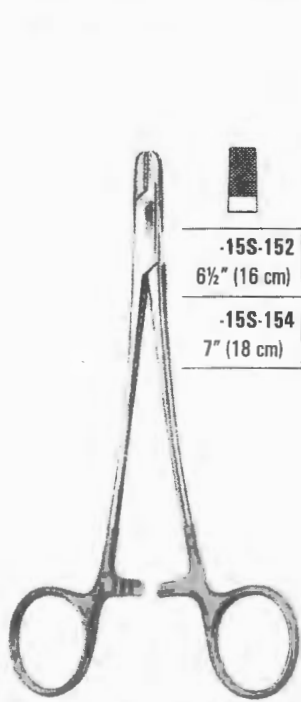

Wire Twisting Forceps

<b>-15S-152</b> 6½" (16 cm)	<b>-15S-153</b> 6½" (16 cm)
<b>-15S-154</b> 7" (18 cm)	<b>-15S-155</b> 7" (18 cm)

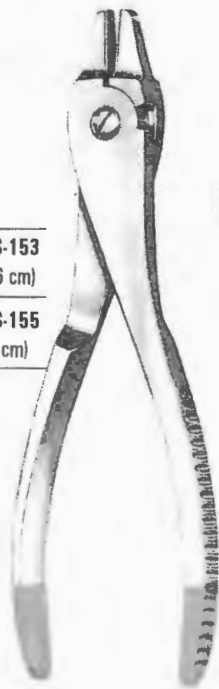

**-15S-156**  
Wire Holding Plier  
7" (18 cm)



Flat Nose Plier  
7" (18 cm)



**-15S-157**



**-15S-158**



**-15S-159**



**-15S-160**  
Wire Cutting Plier  
5½" (14 cm)

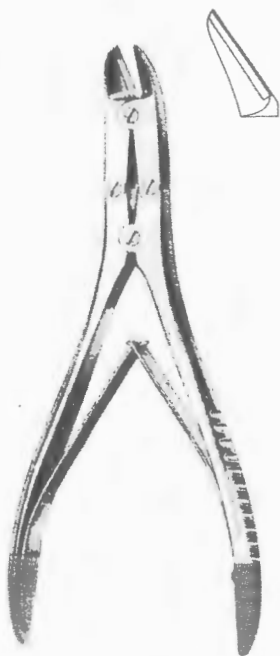

**-15S-161**  
Mini Wire Cutting Plier  
6½" (16 cm)



**-15S-162**  
Cotting Plier Front and Side Cutter  
7" (18 cm)



**-15S-163**  
Wire Cutting Plier  
9" (23 cm)

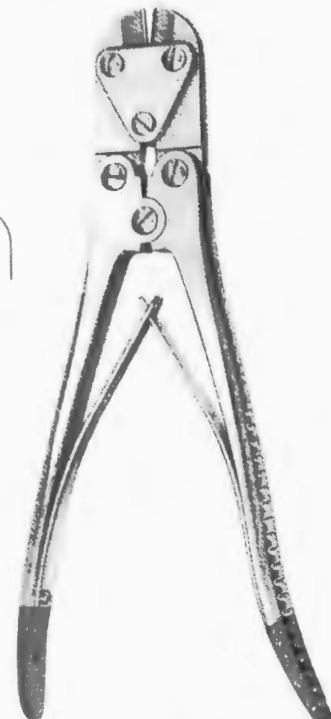

**-15S-164**  
Bone Plate Cutter  
9½" (24 cm)

# LASER SURGERY INSTRUMENTS



16S

Available in Black & Blue Laser Coating

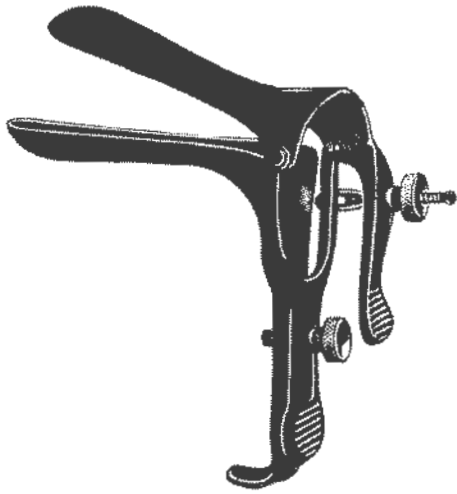

Laser Graves Vaginal Speculum

-16S-001	3" x ¾"	Small
-16S-002	4" x 1¼"	Medium
-16S-003	4½" x 1¾"	Large
-16S-004	3" x ½"	Extra Small
-16S-005	4¾" x 1½"	Extra Large

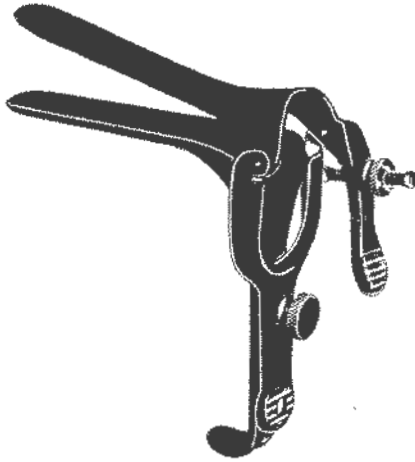

Laser Pederson Vaginal Speculum

-16S-006	3" x ½"	Small
-16S-007	4½" x 1"	Large
-16S-008	4" x ¾"	Slender
-16S-009	4" x ¾"	Medium
-16S-010	2¾" x ¾"	Extra Small

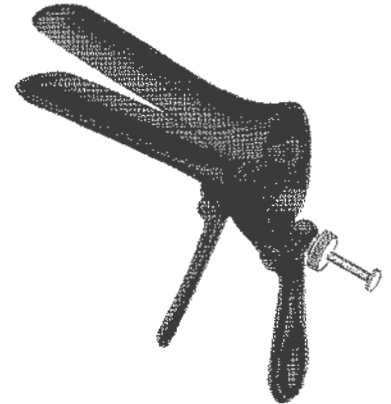

Laser Cusco Vaginal Speculum

-16S-011	3" x ¼"	Small
-16S-012	3½" x 1"	Medium
-16S-013	3¾" x ¾"	Large

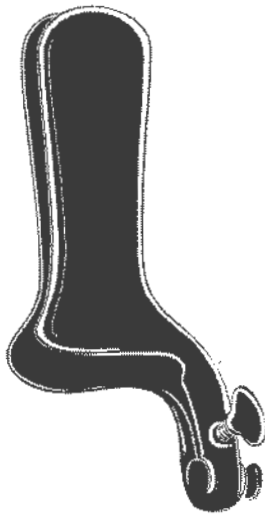

Laser Collin Vaginal Speculum

-16S-014	1½" x 3¼"	Small
-16S-015	1½" x 4"	Medium
-16S-016	1½" x 4½"	Large



Laser Auvard Vaginal Speculum

-16S-017	2½ lbs. Without loop	Medium
-16S-018	2½ lbs. With loop	Medium

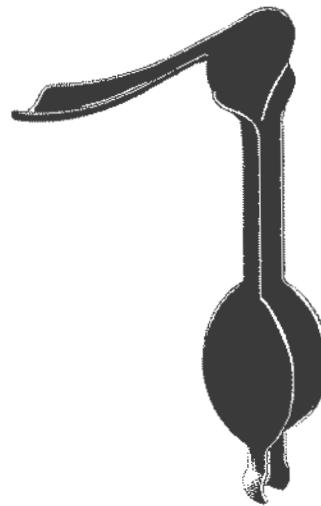

Laser Steiner-Auvard Vaginal Speculum

-16S-019	2½ lbs. Without loop	Medium
-16S-020	2½ lbs. With loop	Medium

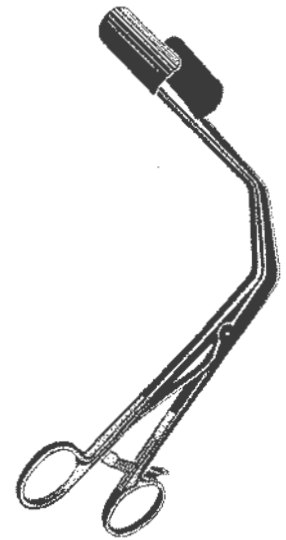

-16S-021  
Laser Lateral Vaginal Speculum  
8¾" (21 cm)



16S

# LASER SURGERY INSTRUMENTS

Available in Black & Blue Laser Coating



Laser Kogan Endospeculum

-16S-022	9½" (24 cm)
-16S-023	11" (28 cm)

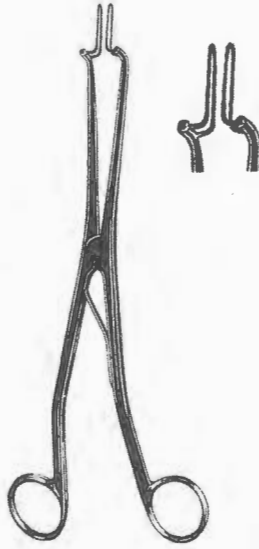

Laser Kogan Endospeculum

-16S-024	9½" (24 cm)
-16S-025	11" (28 cm)

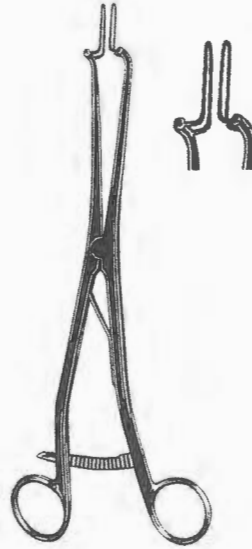

Laser Kogan Endospeculum

-16S-026	9½" (24 cm)
-16S-027	11" (28 cm)



-16S-028  
Laser Kogan Endospeculum  
9" (23 cm)



-16S-029  
Laser Campion Grasping Forceps  
Curved 9" (23cm)



-16S-030  
Laser Bozeman Forceps  
One Large Ring 10" (25 cm)



-16S-031  
Laser Bozeman Forceps  
S-Curve 10" (25 cm)



Laser Schroeder Tenaculum Forceps

-16S-032	9½" (24 cm)	(Braun)
-16S-033	10¼" (26 cm)	(Pozzi)

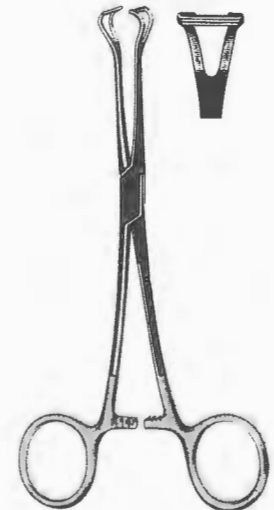

-16S-034  
Laser Babcock Forceps  
8" (20 cm)



# LASER SURGERY INSTRUMENTS



16S

Available in Black & Blue Laser Coating

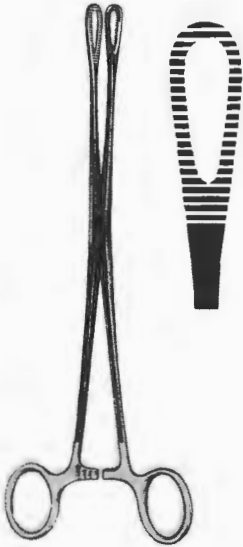

**-16S-035**  
Laser Schweizer Forceps Straight  
9½" (24 cm)

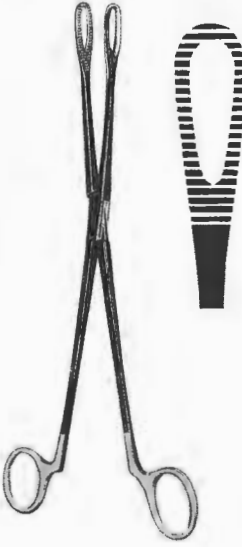

**-16S-036**  
Laser Clemestson Forceps  
9½" (24 cm)



**-16S-037**  
Laser Laufe Uterine Polyp Forceps Curved  
7¾" (19,5 cm)



**-16S-038**  
Laser Heaney Needle Holder  
8¾" (21 cm)



Laser Mayo-Hegar Needle Holder

<b>-16S-039</b>	7" (18 cm)
<b>-16S-040</b>	8" (20 cm)



**-16S-041**  
Laser Jackson Retractor  
3½" x 1½"

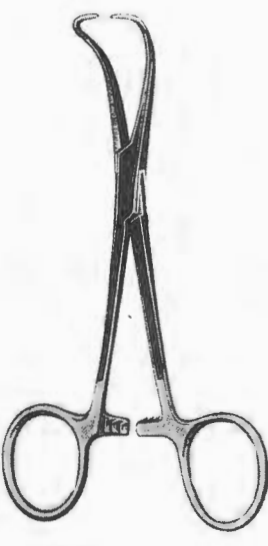

Laser Backhaus Towel Clamp

<b>-16S-043</b>	3½" (9 cm)
<b>-16S-044</b>	5¾" (13 cm)



16S

# LASER SURGERY INSTRUMENTS

Available in Black & Blue Laser Coating

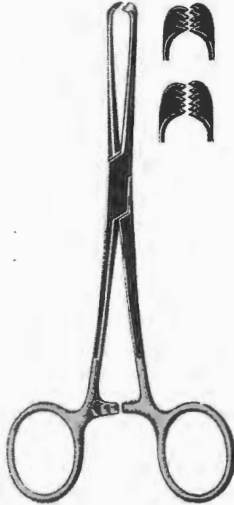

Laser Allis Tissue Forceps

-16S-045	5" (12,5 cm)	Baby Allis
-16S-046	7½" (19 cm)	Allis, 5 x 6
-16S-047	9½" (24 cm)	Allis, 5 x 6

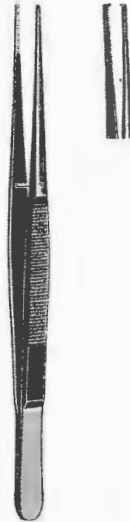

Potts-Smith Forceps

-16S-048	7" (18 cm)	Serrated
-16S-049	10" (25 cm)	Serrated



De-Bakey Atraumatic Tissue Forceps  
2,0 mm Jaws

-16S-050	7¼" (19,5 cm)
-16S-051	9½" (24 cm)



Laser Tuttle / Singley Forceps

-16S-052	7" (18 cm)	Tuttle
-16S-053	9" (23 cm)	Singley



-16S-054

Laser Adson Tissue Forceps  
Serrated, 4¼" (12 cm)

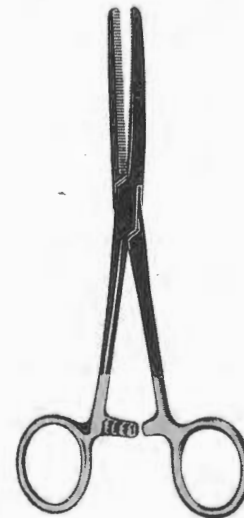

Laser Rochester-Pean Forceps

-16S-055	7¼" (18,5 cm)	Straight
-16S-056	7¼" (18,5 cm)	Curved

# HOLLOWARE

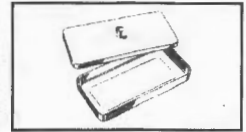

17S



Forceps Jar

ARTICLE #	SIZE
-17S-001	2" x 5"
-17S-002	4" x 8"



-17S-003

Ointment Jar  
Size: 08oz



-17S-004

Cotton Wool Dispenser



-17S-005

Cotton Wool Dispenser

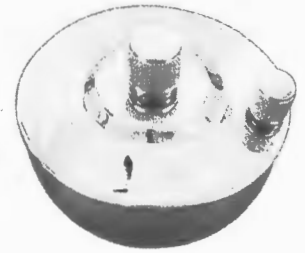

-17S-006

Alcohol Lamp

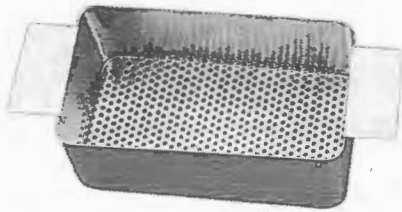

-17S-007

Sterilizing Tray  
8 1/2" x 4 1/2" x 3"

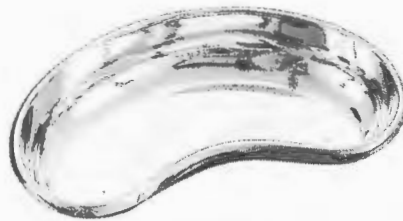

Kidney Tray

ARTICLE #	SIZE
-17S-008	150 mm
-17S-009	170 mm
-17S-010	200 mm
-17S-011	250 mm
-17S-012	280 mm
-17S-013	300 mm



Instrument Tray

ARTICLE #	SIZE
-17S-014	150 x 100 x 40 mm
-17S-015	200 x 150 x 40 mm
-17S-016	255 x 200 x 40 mm
-17S-017	300 x 150 x 40 mm
-17S-018	300 x 200 x 50 mm
-17S-019	300 x 255 x 50 mm
-17S-020	310 x 200 x 60 mm
-17S-021	330 x 250 x 50 mm
-17S-022	355 x 255 x 50 mm
-17S-023	355 x 300 x 50 mm
-17S-024	400 x 300 x 55 mm
-17S-025	460 x 300 x 55 mm
-17S-026	460 x 360 x 55 mm



Instrument Tray with Lid

ARTICLE #	SIZE
-17S-027	150 x 100 x 40 mm
-17S-028	200 x 150 x 40 mm
-17S-029	255 x 200 x 40 mm
-17S-030	300 x 150 x 40 mm
-17S-031	300 x 200 x 50 mm
-17S-032	300 x 255 x 50 mm
-17S-033	310 x 200 x 60 mm
-17S-034	330 x 250 x 50 mm
-17S-035	355 x 255 x 50 mm
-17S-036	355 x 300 x 50 mm
-17S-037	400 x 300 x 55 mm
-17S-038	460 x 300 x 55 mm
-17S-039	460 x 360 x 55 mm



Catheter Tray

ARTICLE #	SIZE
-17S-040	300 x 75 x 40 mm
-17S-041	350 x 90 x 50 mm
-17S-042	400 x 100 x 50 mm



Mayo Tray

ARTICLE #	SIZE
-17S-043	400 x 300 x 20 mm
-17S-044	450 x 320 x 20 mm
-17S-045	460 x 360 x 20mm

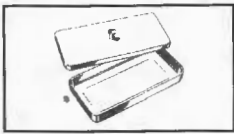

17S

# HOLLOWWARE

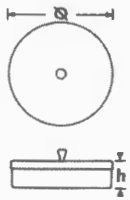

Cotton Wool Container

Lid with Knob

Ø x h	
75 x 60	-17S-046
75 x 75	-17S-047
100 x 60	-17S-048
100 x 100	-17S-049
125 x 80	-17S-050
125 x 125	-17S-051
150 x 150	-17S-052

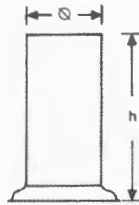

JAR



Ø x h	Jar without Lid	Lid Only	Lid Only with Triangle hole
30 x 90	-17S-053		
50 x 100	-17S-054	-17S-061	-17S-068
50 x 130	-17S-055	-17S-062	-17S-069
50 x 175	-17S-056	-17S-063	-17S-070
75 x 100	-17S-057	-17S-064	-17S-071
75 x 130	-17S-058	-17S-065	-17S-072
100 x 175	-17S-059	-17S-066	-17S-073
100 x 200	-17S-060	-17S-067	-17S-074

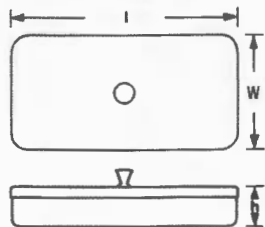
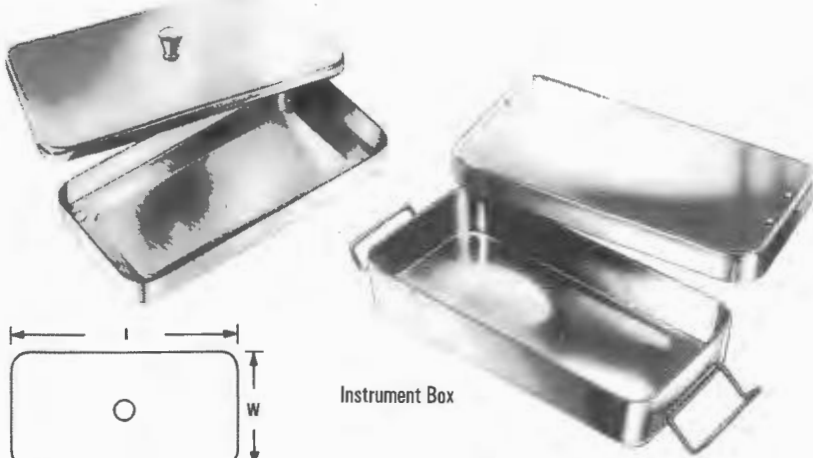

Instrument Box

Size in mm l x b x h	Lid with Knob	Lid without Knob
165 x 85 x 35	-17S-075	-17S-083
200 x 100 x 35	-17S-076	-17S-084
200 x 100 x 50	-17S-077	-17S-085
230 x 130 x 50	-17S-078	-17S-086
260 x 150 x 50	-17S-079	-17S-087
270 x 235 x 50	-17S-080	-17S-088
300 x 200 x 50	-17S-081	-17S-089
325 x 275 x 50	-17S-082	-17S-090



-17S-091  
Bucket Only  
Size:  
Dia: 335 mm  
Height: 240 mm  
Base: 215 mm

-17S-092  
Bucket Kick Stand  
(Stand Only)

# HOLLOWWARE



17S



Sterilizer Drum

ARTICLE #	SIZE
-17S-093	80 x 80 mm
-17S-094	120 x 120 mm
-17S-095	140 x 140 mm
-17S-096	160 x 120 mm
-17S-097	160 x 150 mm
-17S-098	190 x 150 mm
-17S-099	190 x 190 mm
-17S-100	240 x 160 mm
-17S-101	240 x 240 mm
-17S-102	290 x 160 mm
-17S-103	290 x 240 mm
-17S-104	340 x 160 mm
-17S-105	340 x 240 mm
-17S-106	390 x 190 mm
-17S-107	390 x 290 mm



Emises Basin

-17S-108	12" (4 LTR)
-17S-109	13" (6 LTR)
-17S-110	14" (8 LTR)



-17S-111  
Urinal - Male



-17S-112  
Urinal - Female



-17S-113  
Bedpan Slipper Type



-17S-114  
Bedpan American

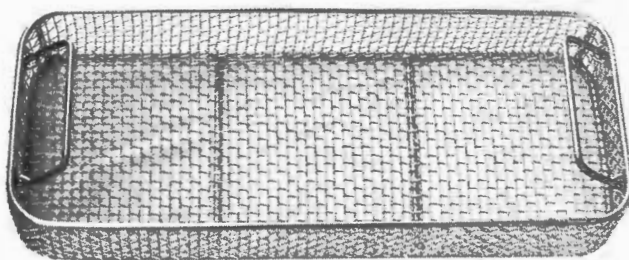

Wire Mesh Tray

ARTICLE #	SIZE
-17S-115	230 x 130 x 50 mm
-17S-116	240 x 130 x 50 mm
-17S-117	240 x 250 x 60 mm
-17S-118	480 x 250 x 50 mm
-17S-119	480 x 250 x 70 mm
-17S-120	500 x 300 x 50 mm
-17S-121	480 x 480 x 50 mm
-17S-122	300 x 300 x 60 mm
-17S-123	500 x 300 x 60 mm
-17S-124	600 x 300 x 60 mm



Sterilizing Container

ARTICLE #	SIZE
-17S-125	220 x 120 x 50 mm
-17S-126	230 x 130 x 50 mm
-17S-127	260 x 150 x 50 mm
-17S-128	300 x 200 x 50 mm

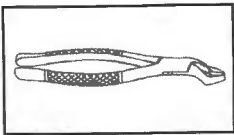

01D

# EXTRACTING FORCEPS

(American Pattern)

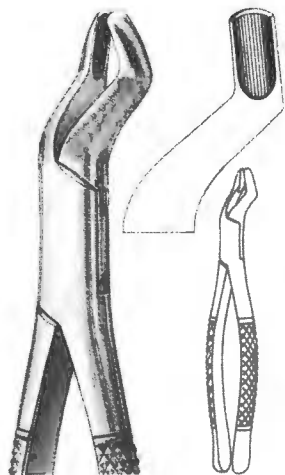

**-01D-001**  
Upper Molars, Universal  
# 10S

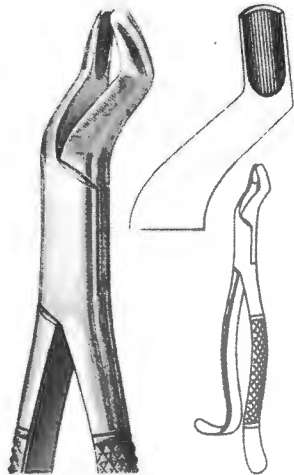

**-01D-002**  
Upper Molars, Hook Handle,  
Universal # 10H

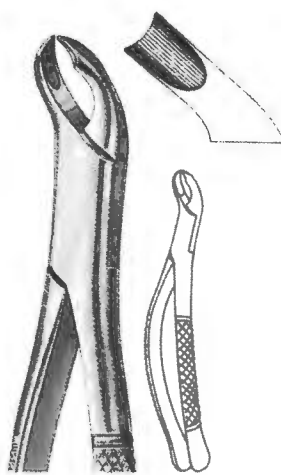

**-01D-003**  
Upper Molars, Left  
# 90

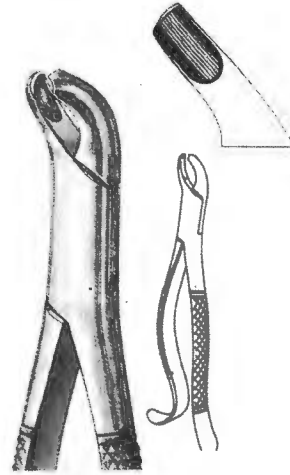

**-01D-004**  
1st & 2nd Upper Molar, Left  
# 18L

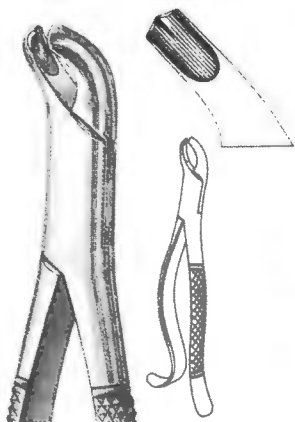

**-01D-005**  
1st & 2nd Upper Molar, Right  
# 18R

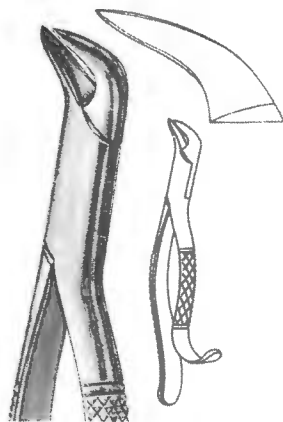

**-01D-006**  
1st & 2nd Lower Molars,  
Universal, Cow Horn # 16

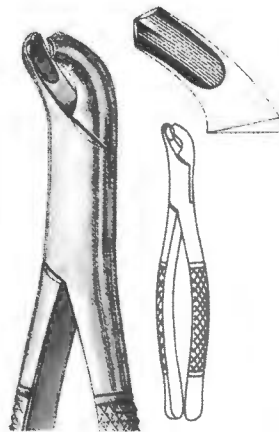

**-01D-007**  
1st & 2nd Lower Molars,  
Universal # 17

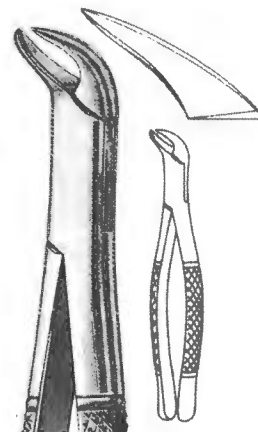

**-01D-008**  
1st & 2nd Lower Molars,  
Universal, Cow Horn # 23

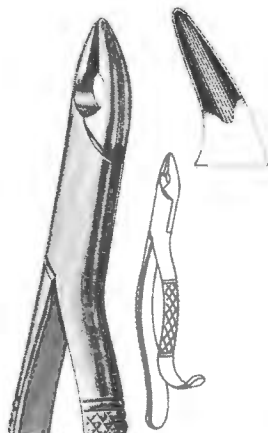

**-01D-009**  
Lower Molars, Cuspids  
& Bicuspids, Universal # 85

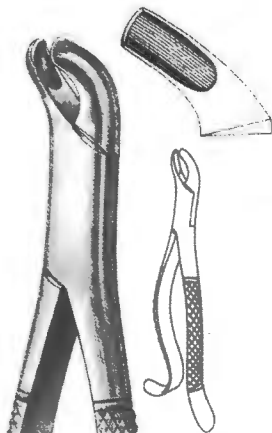

**-01D-010**  
Upper Molars, Universal  
# 24

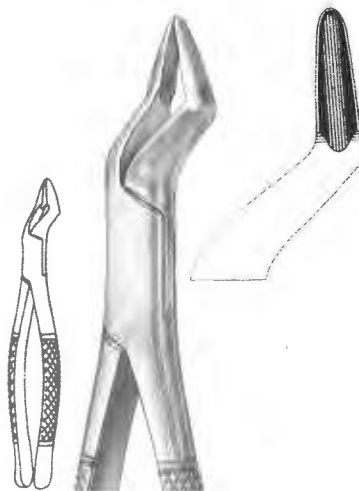

**-01D-011**  
Upper Cuspid, Bicuspids  
& Molars, Universal # 32

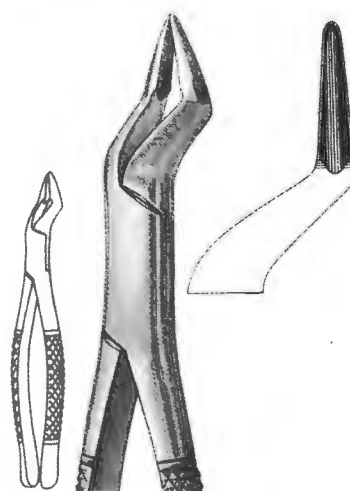

**-01D-012**  
Upper Cuspid, Bicuspids  
& Molars, Universal # 32A

# EXTRACTING FORCEPS

(American Pattern)

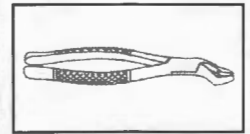

01D

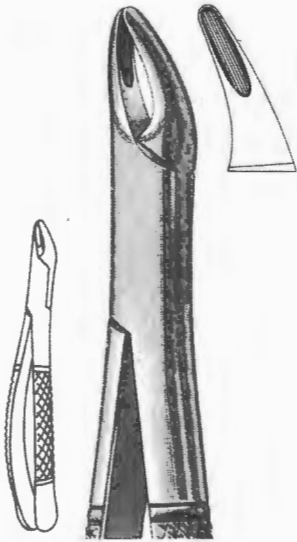

-01D-013

Upper Incisors, Cuspid, Bicuspid  
& Roots; Universal # 150

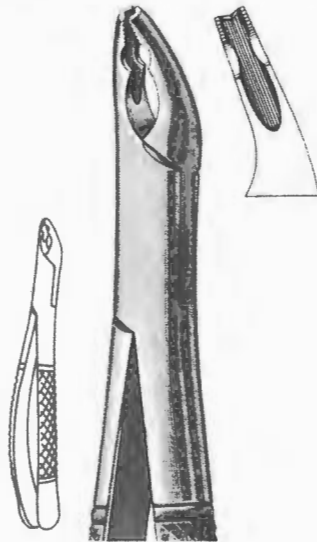

-01D-014

Upper Anteriors; Split Beaks; Serrated  
# 150AS

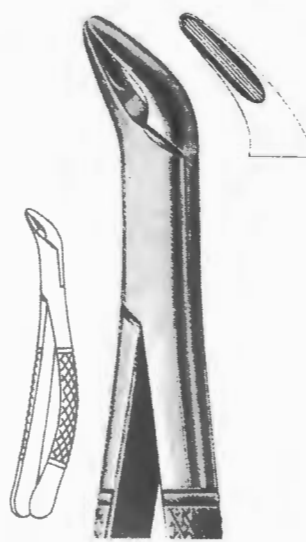

-01D-015

Lower Incisors, Cuspid,  
Bicuspid & Roots; Universal  
# 151

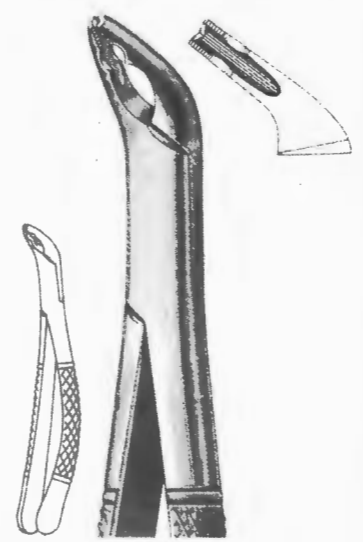

-01D-016

Lower Anteriors; Split Beaks; Serrated  
# 151 AS

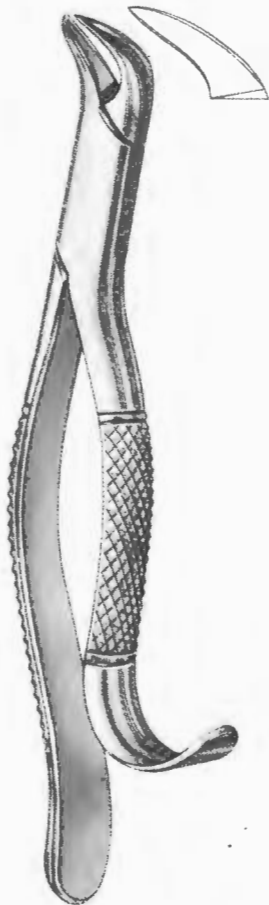

-01D-017

Pedo Lower Molars, Cow Horn  
# 16S

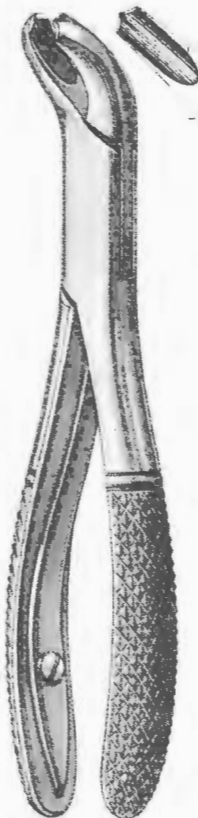

-01D-018

Pedo Lower Molars  
Universal, Spring Handle # 17S

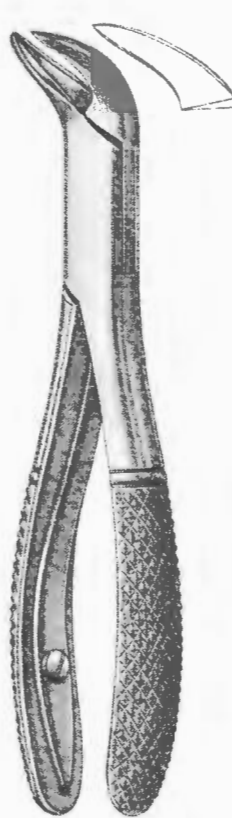

-01D-019

Pedo Lower Molars Universal,  
Cow Horn, Spring Handle # 23S

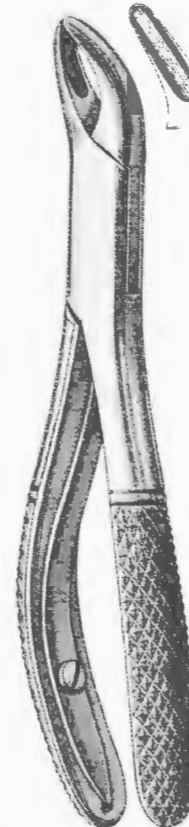

-01D-020

Pedo Upper Incisors, Bicuspid  
& Roots, Universal, Spring Handle  
# 150½S

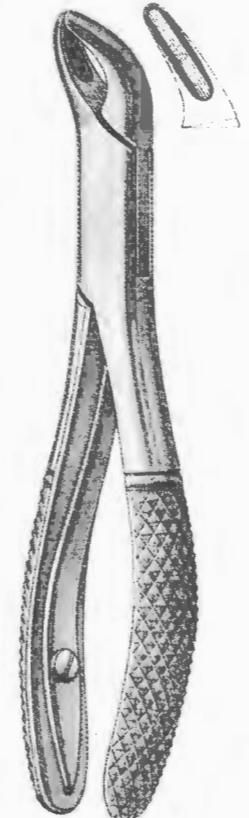

-01D-021

Pedo Lower Incisors, Bicuspid  
& Roots, Universal, Spring Handle  
# 151½S



01D

# EXTRACTING FORCEPS

(European Pattern)

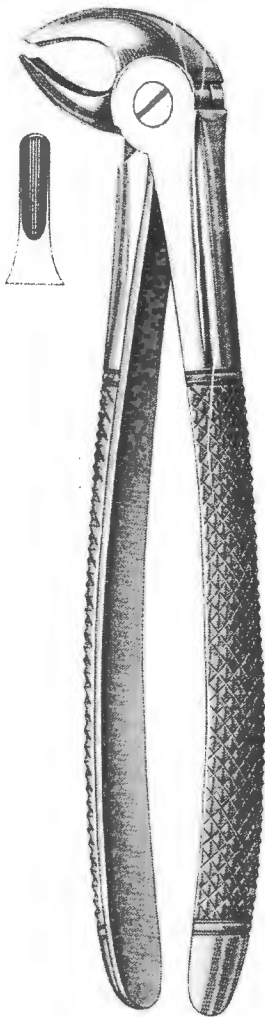

**-01D-022**  
Lower Bicuspids, Universal  
# 13

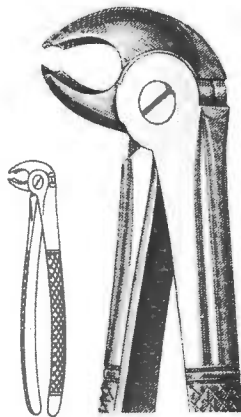

**-01D-023**  
Lower Molars, Universal  
# 22

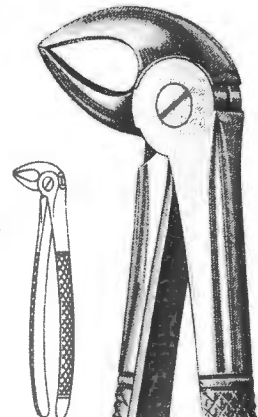

**-01D-024**  
Lower Roots  
# 23



**-01D-025**  
Lower Roots, Narrow Beaks  
# 27



**-01D-026**  
Lower Molars, Universal  
# 73



**-01D-027**  
Lower Roots  
# 74

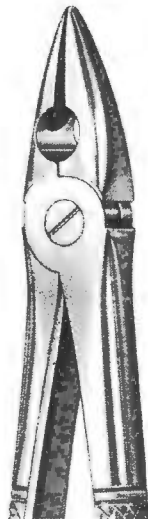

**-01D-028**  
Upper Incisors, Cuspids, Bicuspids  
and Roots, Mead, Universal # MD1

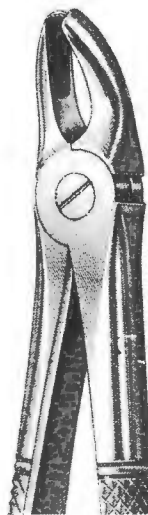
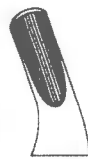

**-01D-029**  
Upper 1st, 2nd and 3rd  
Molars, Mead, Universal # MD2



**-01D-030**  
Lower Incisors, Cuspids, Bicuspids  
and Roots, Mead, Universal # MD3



**-01D-031**  
Lower 1st, 2nd and 3rd  
Molars, Mead, Universal # MD4



# ELEVATORS

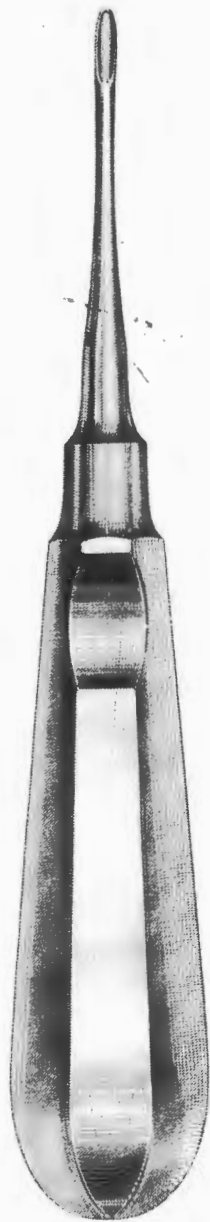

-02D-001



-02D-002



-02D-003



-02D-004

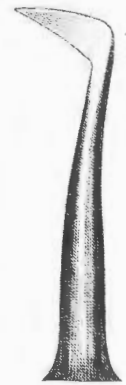

-02D-005



-02D-006



-02D-007



-02D-008



-02D-009



-02D-010



-02D-011



-02D-012



-02D-013

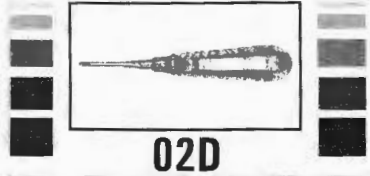

# ELEVATORS

## Root Tip

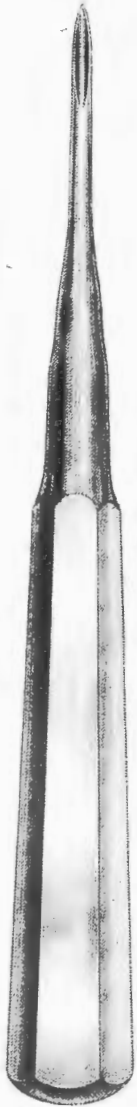

-02D-014



-02D-015



-02D-016

## Heidbrink Root-Tip Picks



-02D-017



-02D-018



-02D-019

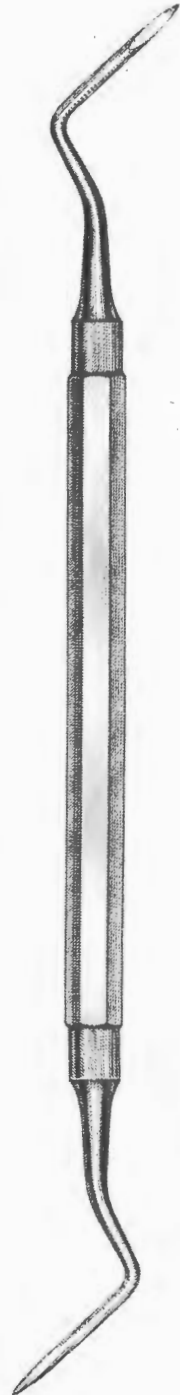

-02D-020

ELEVATORS

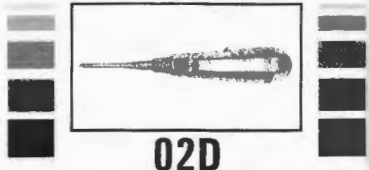

Potts Elevator

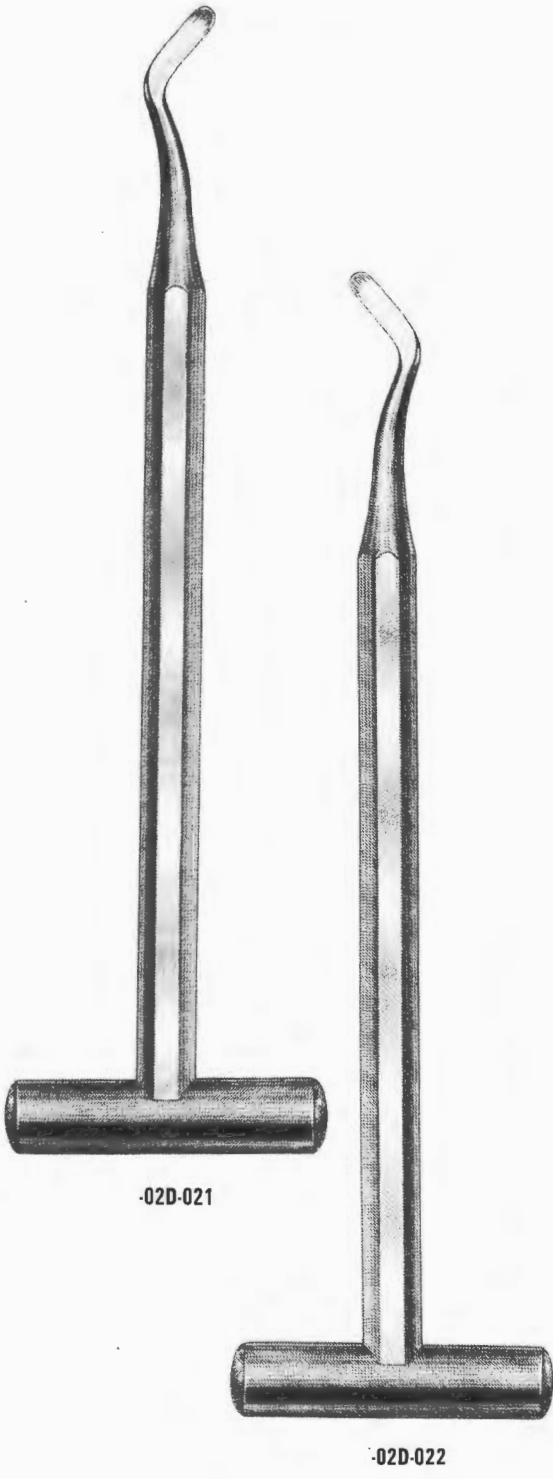

Priosteal Elevator

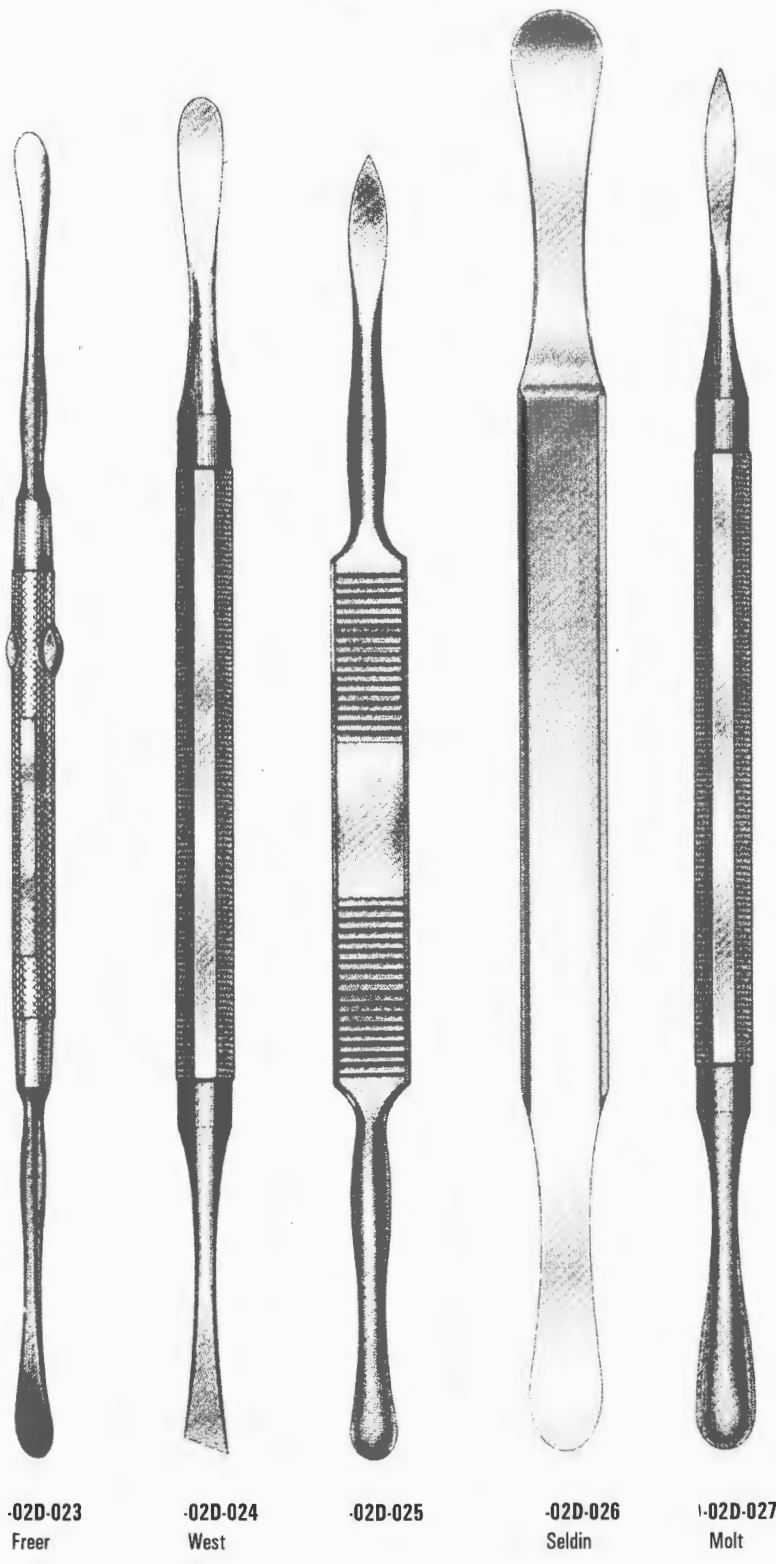

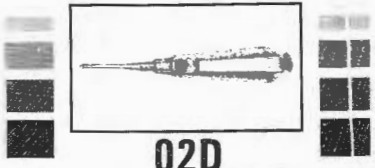

02D

# ELEVATORS

## Lucas

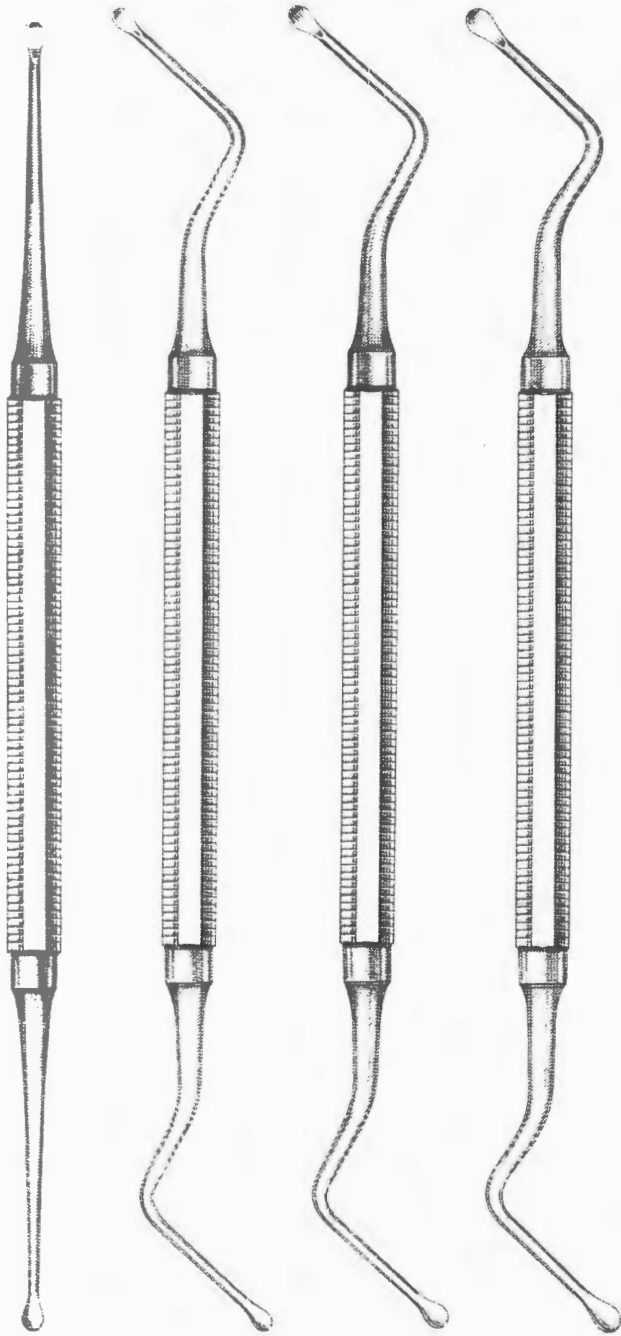

-02D-028

-02D-029

-02D-030

-02D-031

## Muli

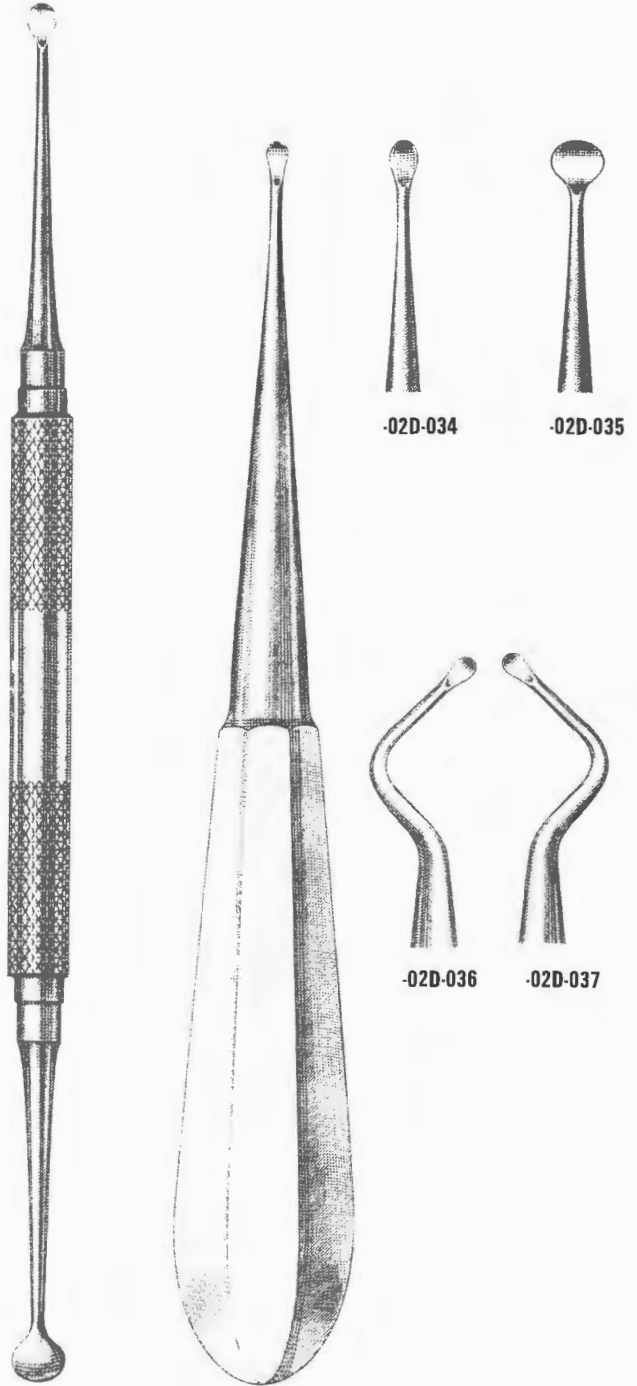

-02D-034

-02D-035

-02D-036

-02D-037

-02D-032

-02D-033

# MIRROR + HANDLE

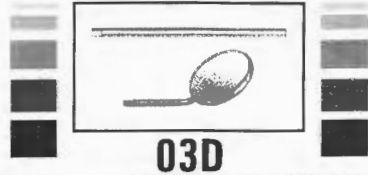

03D



**CONE SOCKET**  
Mirror Only

- 03D-001 #3
- 03D-002 #4
- 03D-003 #5



**SIMPLE STEM**  
Mirror Only

- 03D-004 #3
- 03D-005 #4
- 03D-006 #5

20 mm  
3/4"  
Size  
3

22 mm  
7/8"  
Size  
4

24 mm  
15/16"  
Size  
5

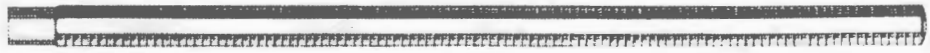

-03D-007  
Octagonal Dental Mirror Handle



-03D-008  
Delux Dental Mirror Handle



-03D-009  
Octagonal Dental Mirror Handle, with millimeter rule

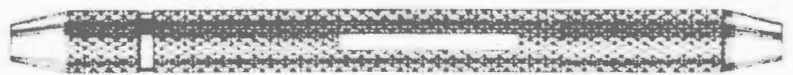

-03D-010  
Double End Dental Mirror Handle



-03D-011  
Autoclavable Front Surface Fiberglass Mirror

# AMALGAM CARRIERS & SYRINGES

04D

## Amalgam Carriers Swiss Pattern

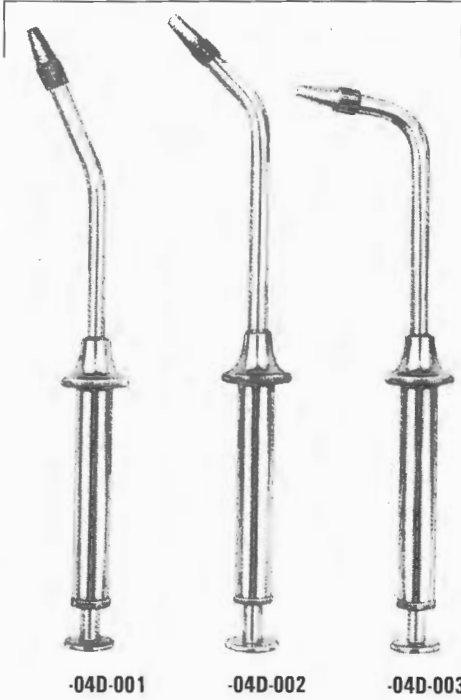

-04D-001

-04D-002

-04D-003

## Amalgam Carriers

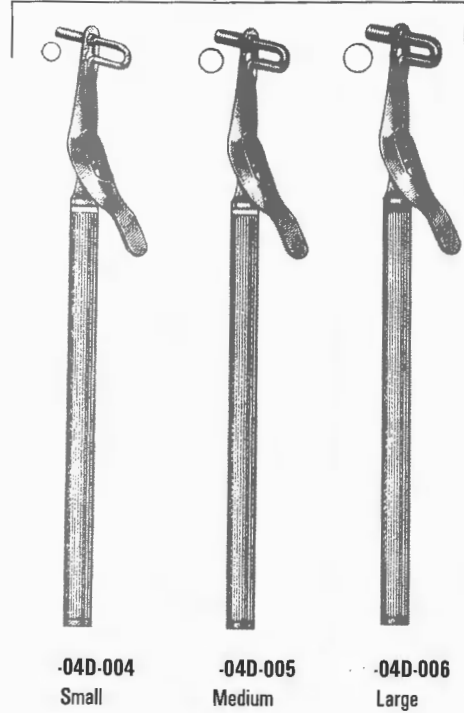

-04D-004  
Small

-04D-005  
Medium

-04D-006  
Large

## Amalgam Carriers (Double End)

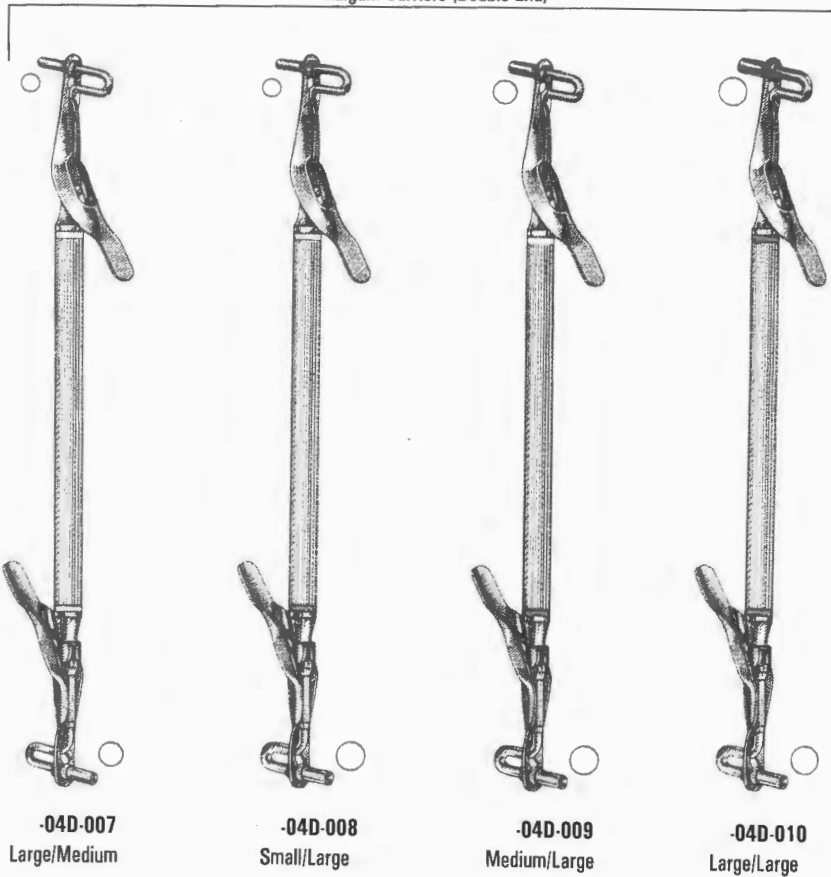

-04D-007  
Large/Medium

-04D-008  
Small/Large

-04D-009  
Medium/Large

-04D-010  
Large/Large

# AMALGAM CARRIERS & SYRINGES

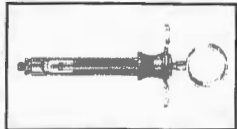

04D

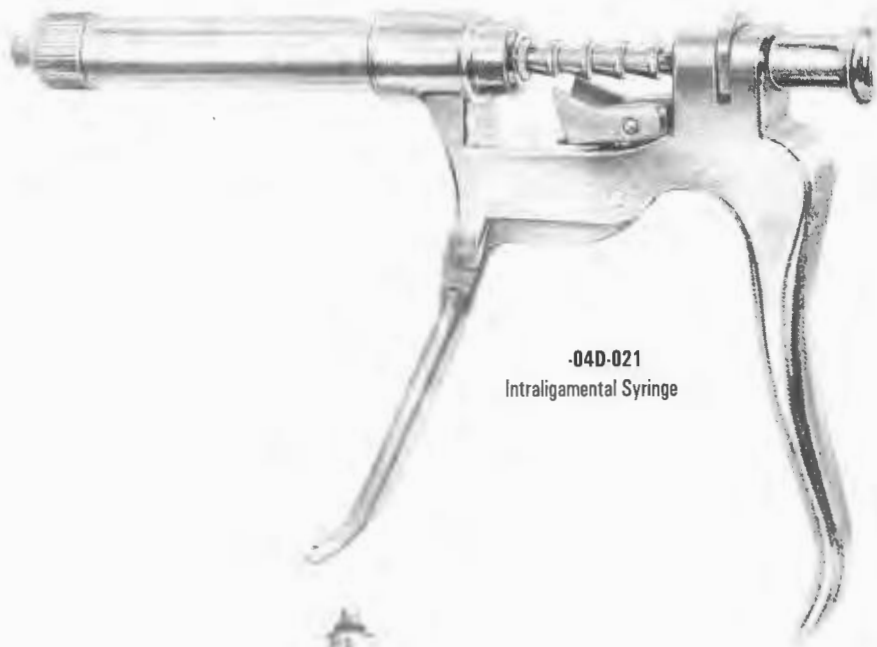

-04D-021  
Intraligamental Syringe

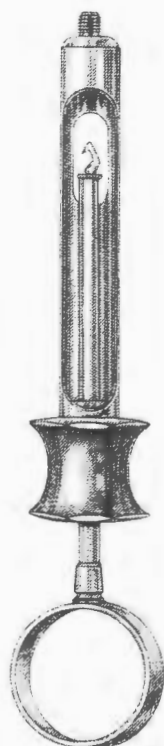

Aspirating Syringe

-04D-013	1,8 cc
-04D-014	2,2 cc

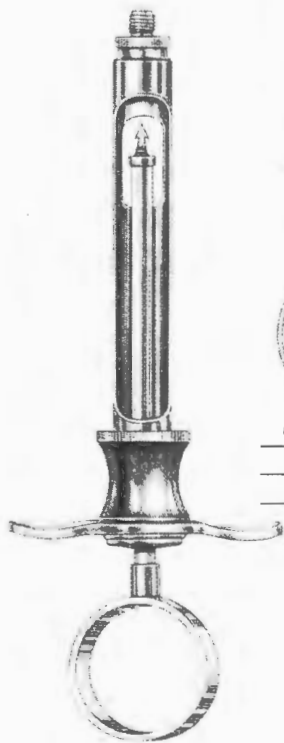

Aspirating Syringe

-04D-011	1,8 cc
-04D-012	2,2 cc

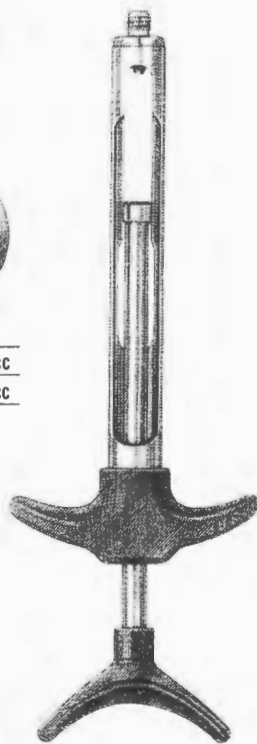

Self-Aspirating Syringe

-04D-015	1,8 cc
-04D-016	2,2 cc



Self-Aspirating Syringe

-04D-017	1,8 cc
-04D-018	2,2 cc



Articulating Barrel Syringe  
(Shown Open)

-04D-019	1,8 cc
-04D-020	2,2 cc



05D

# MISCELLANEOUS

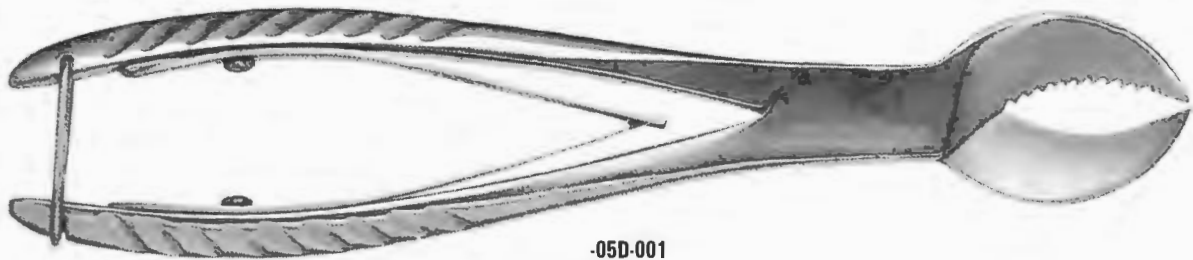

-05D-001  
Cow Horn



-05D-002  
Stiff Blade



-05D-003  
Stiff Blade



-05D-004  
Extra Stiff Blade



-05D-005  
Flexible Blade



-05D-006  
Ball Chain



-05D-007  
Non-Chill  
Clear Plastic



# TUFFLIMIRE, CALIPERS ETC

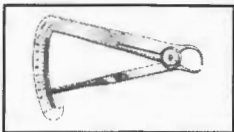

06D

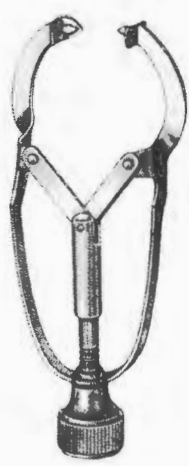

-06D-008

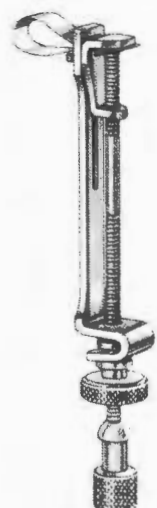

-06D-009

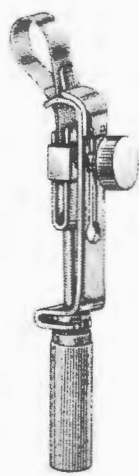

-06D-010



-06D-011  
JUNIOR-CA



-06D-012  
SENIOR-CA



-06D-013  
Universal

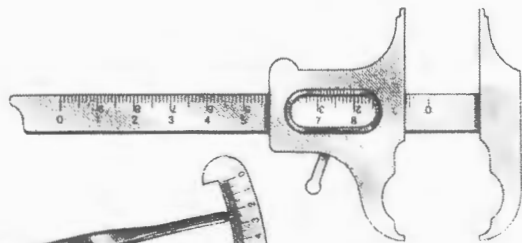

-06D-014  
Boley Gauge,

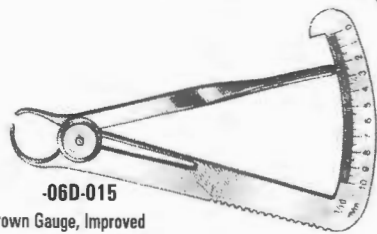

-06D-015  
Crown Gauge, Improved  
Model with 2 Sided Scale

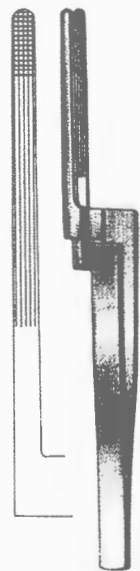

-06D-016  
Standard Articulating Paper Forceps,

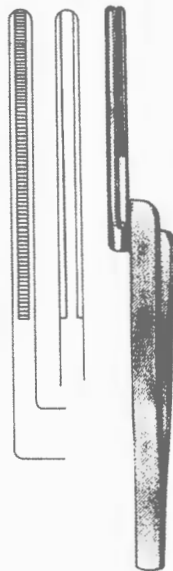

-06D-017  
POSIGRIP Articulating  
Paper Forceps,



-06D-018  
London College Tweezer  
Smooth  
6" (15 cm)



06D-019  
London College Tweezer  
Serrated  
6" (15 cm)



-06D-020  
London College Tweezer  
Serrated/with lock  
6" (15 cm)

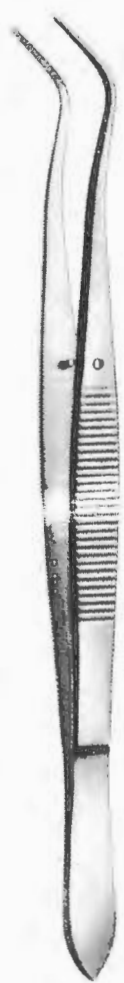

-06D-021  
Meriam Serrated  
6 3/4" (16 cm)



-06D-022  
Meriam Smooth  
6 3/4" (16 cm)

07D

GRACEY CURETTE

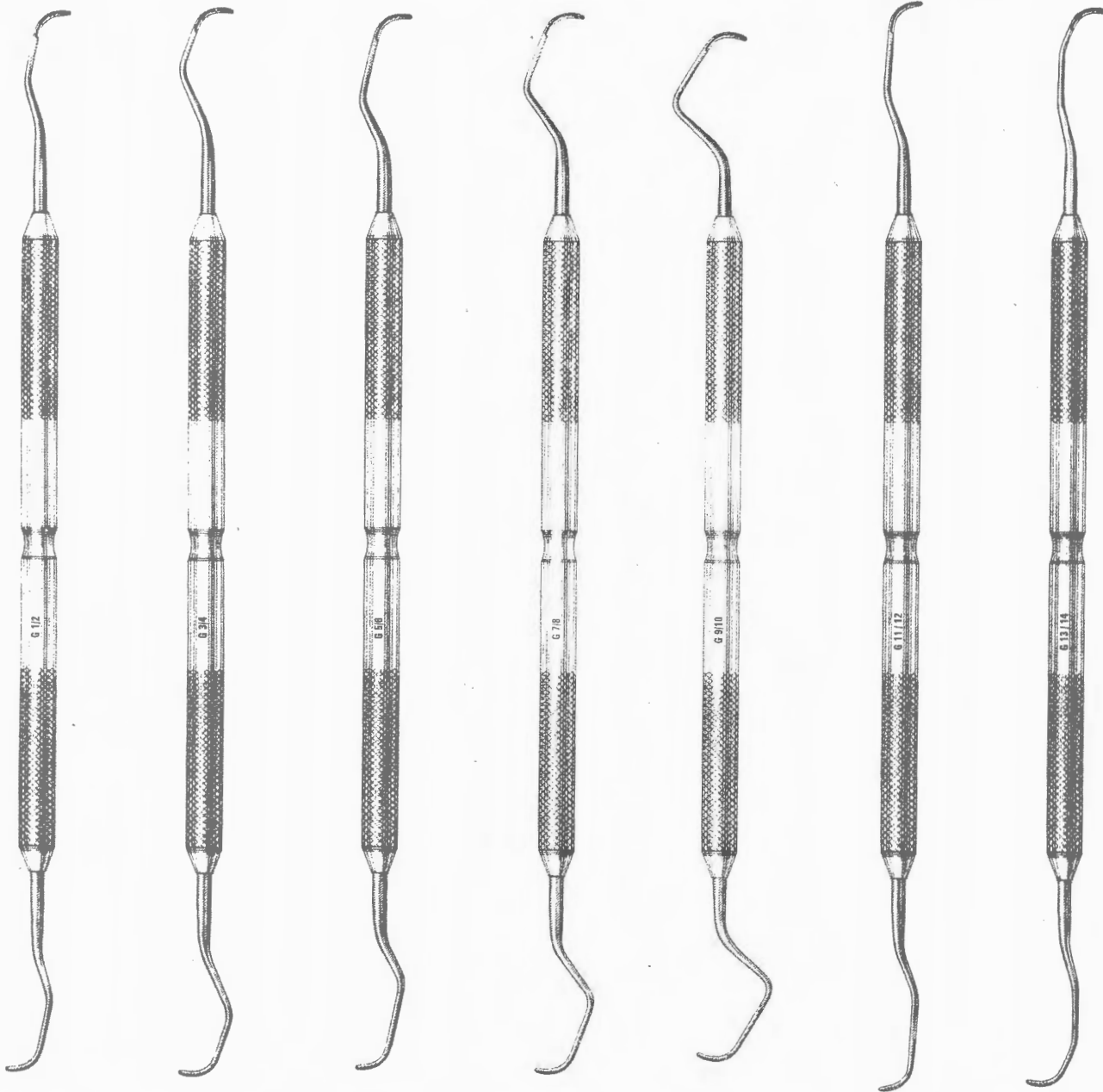

-07D-001

-07D-002

-07D-003

-07D-004

-07D-005

-07D-006

-07D-007

# GENERAL DENTISTRY INSTRUMENTS

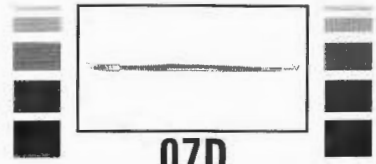

## COLUMBIA CURETTES



-07D-008  
4L-4R

-07D-009  
13-14

-07D-010  
2L-2R

## MCCALLS CURETTES

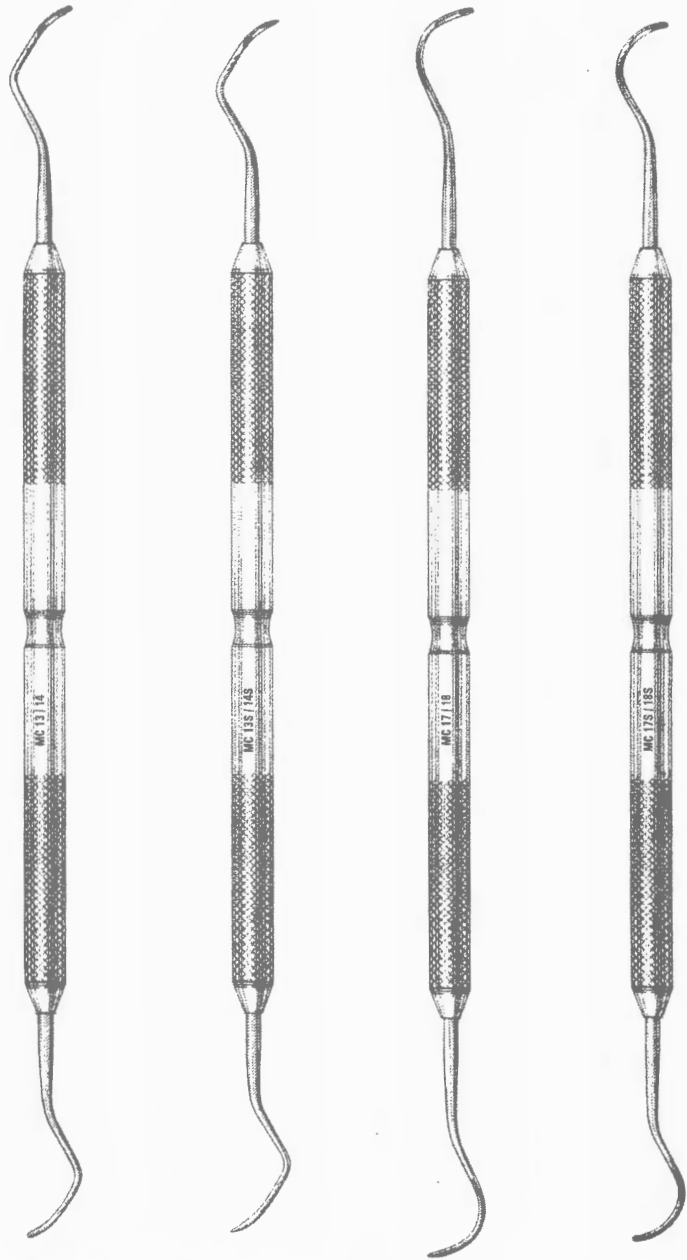

-07D-011  
13-14

-07D-012  
13S-14S

-07D-013  
17-18

-07D-014  
17S-18S

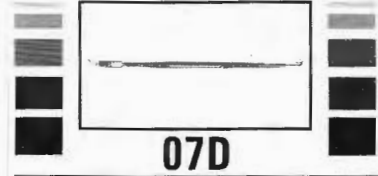

# GENERAL DENTISTRY INSTRUMENTS

## WAX CARVERS

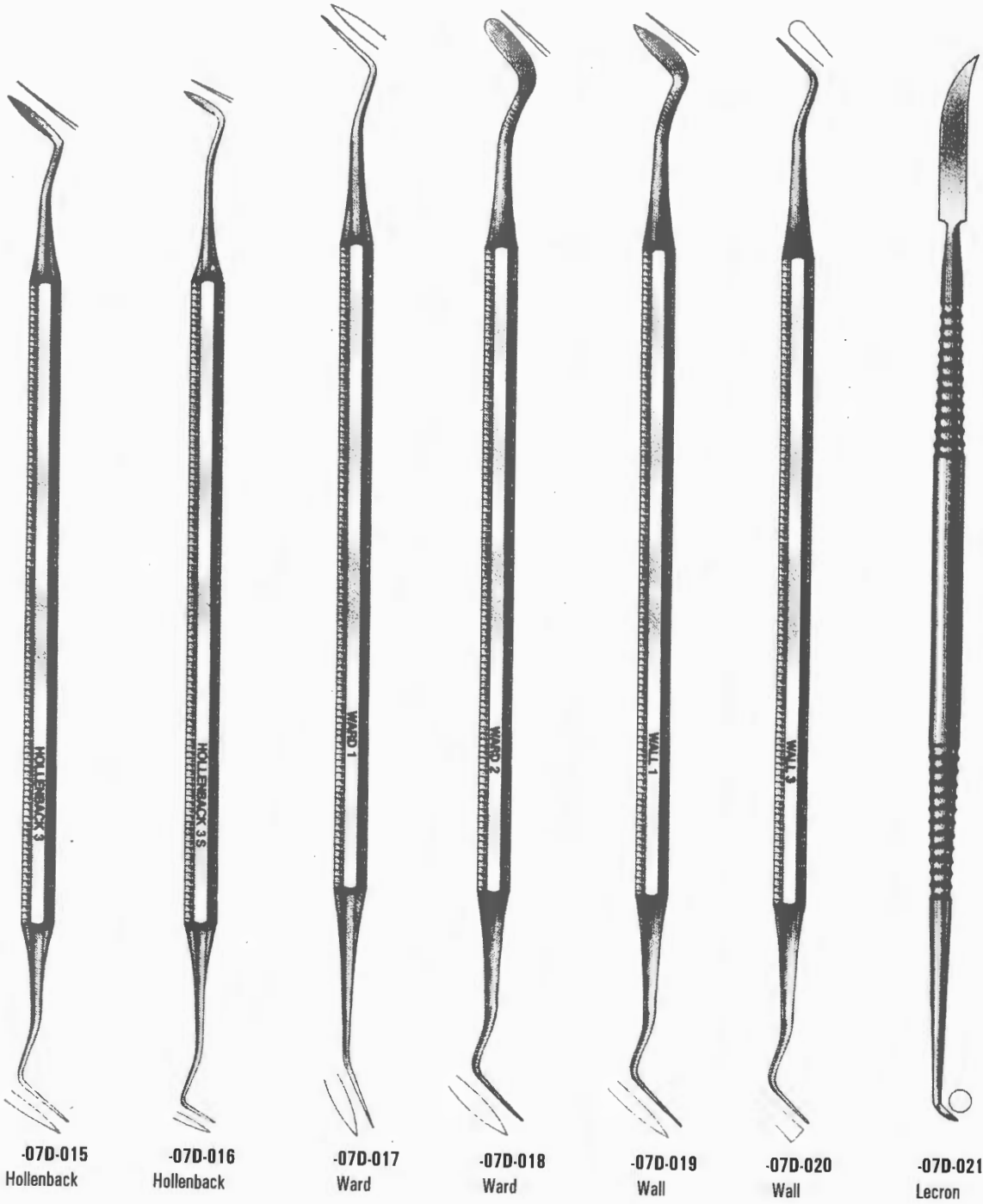

-07D-015  
Hollenback

-07D-016  
Hollenback

-07D-017  
Ward

-07D-018  
Ward

-07D-019  
Wall

-07D-020  
Wall

-07D-021  
Lecron

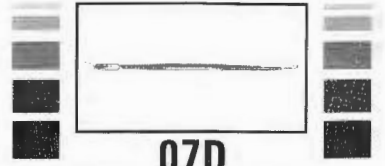

EXCAVATORS

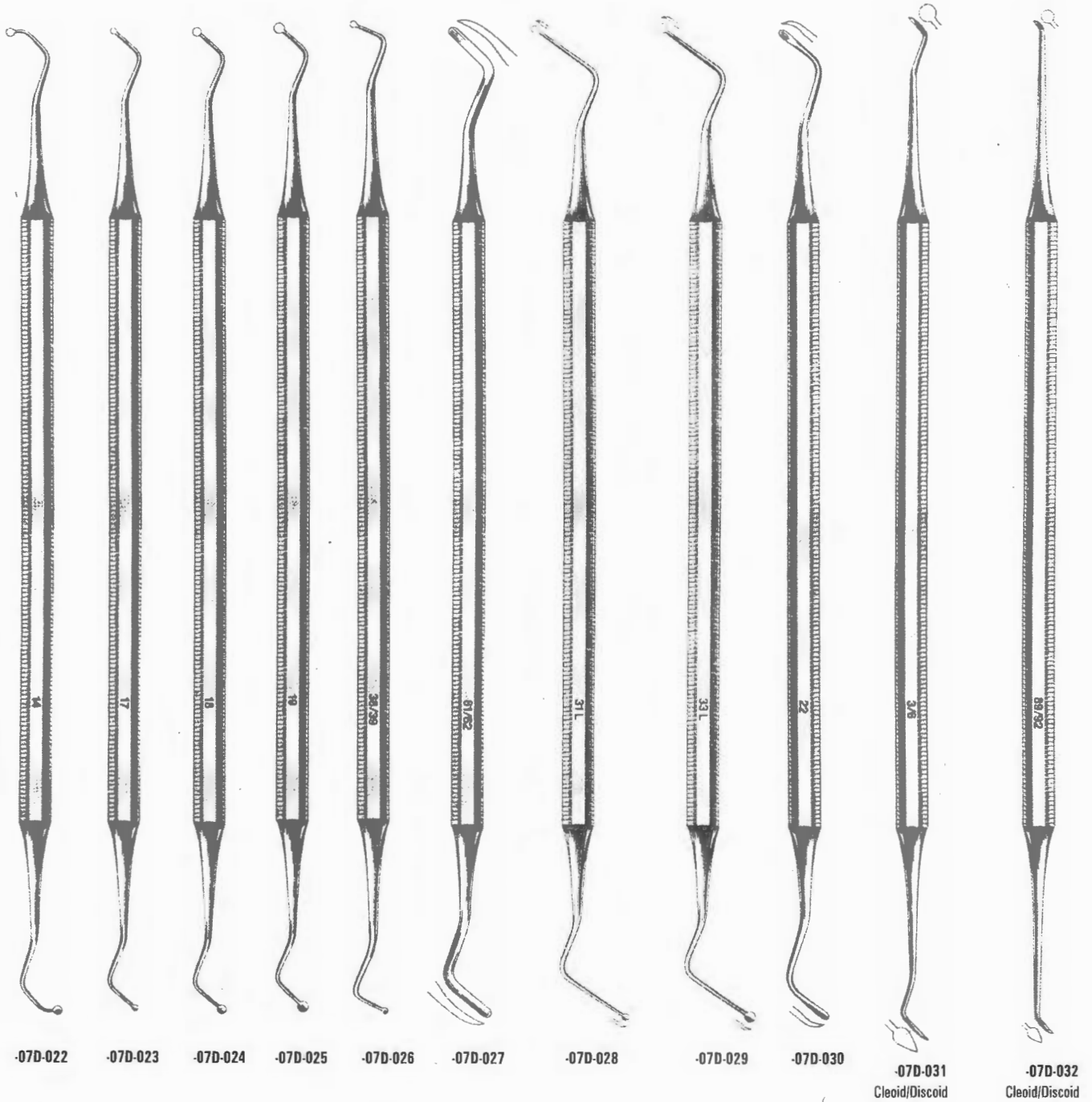

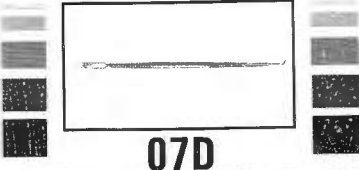

# GENERAL DENTISTRY INSTRUMENTS

07D

## BURNISHERS



-07D-033

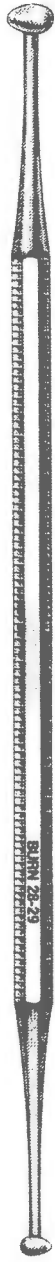

-07D-034



-07D-035



-07D-036



-07D-037



-07D-038

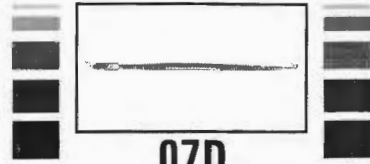

07D

EXPLORERS



-07D-039

-07D-040

-07D-041

-07D-042

-07D-043

-07D-044

-07D-045

-07D-046

-07D-047

-07D-048

-07D-049

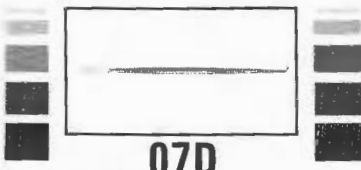

# GENERAL DENTISTRY INSTRUMENTS

## PROBES, EXPLORERS, CEMENT SPATULAS



-07D-050

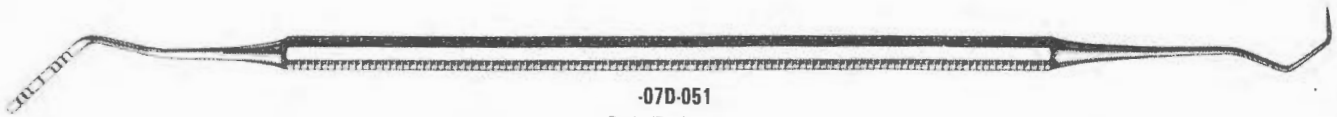

-07D-051  
Probe/Explorer



-07D-052  
Probe/Explorer

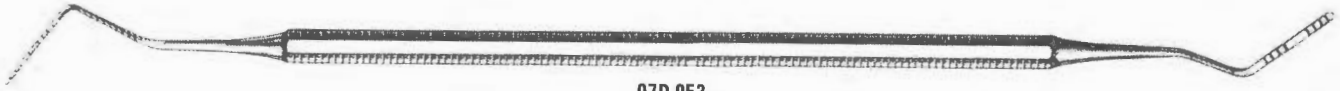

-07D-053  
Probe



-07D-054  
C-313

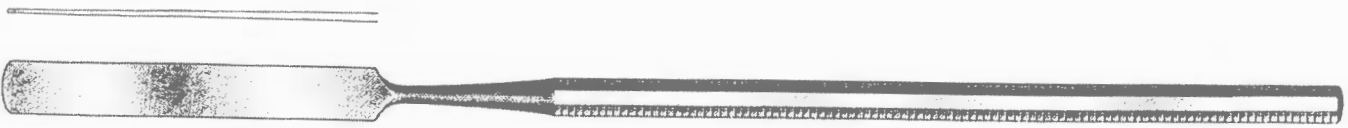

-07D-055



-07D-056

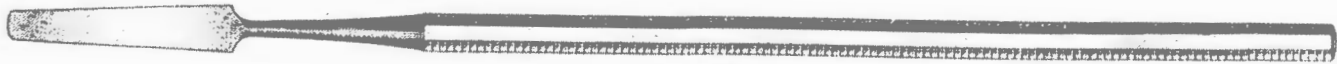

-07D-057



BONE FILES

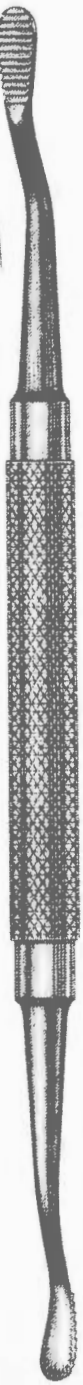

-07D-058  
Howard



-07D-059  
Howard



-07D-060  
Howard

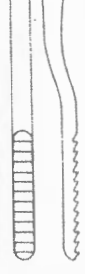
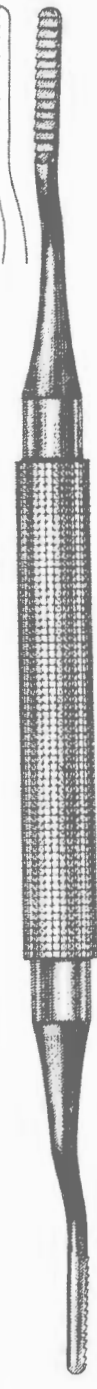
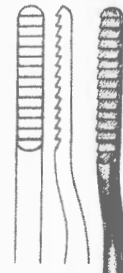

-07D-061  
Polokoff

07D

BONE CHISELS

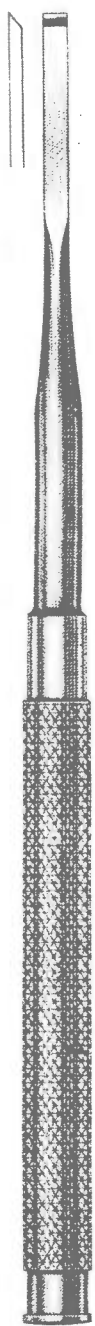

-07D-062  
Gardner

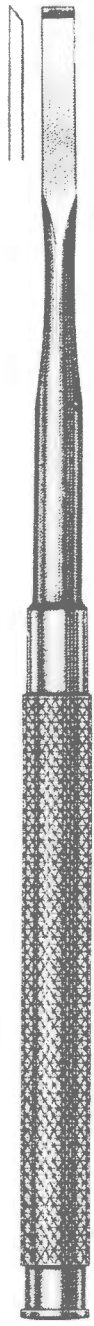

-07D-063  
Gardner

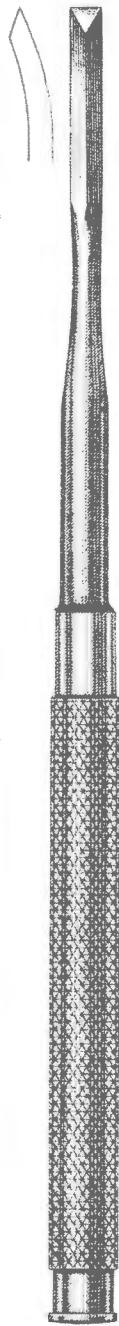

-07D-064  
Gardner



-07D-065  
Gardner



-07D-066  
Wakefield



-07D-067  
Wakefield

# RUBBER DAM FORCEPS & CLAMPS

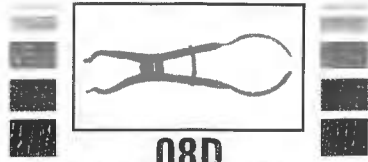

08D



**-08D-001**  
Brewer Rubber Dam Forceps



**-08D-002**  
University of Washington  
Rubber Dam Clamp Forceps



**-08D-003**  
IV Type  
Rubber Dam Clamp Forceps



**-08D-004**  
IV Type Rubber Dam Punch



**-08D-005**  
Ainsworth Rubber Dam Punch



**-08D-006**  
Rubber Dam Frame



08D

# RUBBER DAM FORCEPS & CLAMPS

## RUBBER DAM CLAMPS

### LOWER MOLARS

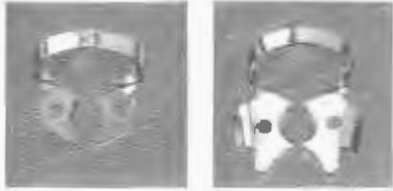

-08D-007



-08D-008



-08D-009



-08D-010



-08D-011



-08D-012



-08D-013



-08D-014



-08D-029



-08D-030



-08D-031



-08D-032



-08D-035



-08D-036

### UPPER MOLARS



-08D-015



-08D-016



-08D-017



-08D-018



-08D-019



-08D-020



-08D-021



-08D-022

### MOLARS



-08D-033



-08D-034



-08D-037



-08D-038



-08D-039

### PRE MOLARS



-08D-023



-08D-024



-08D-025



-08D-026



-08D-027



-08D-028

### ANTERIOR



-08D-040



-08D-041



-08D-042



-08D-043

# PLIERS

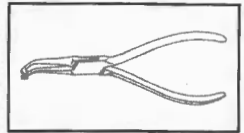

09D



**-09D-001**  
Pesso  
5½" (14 cm)

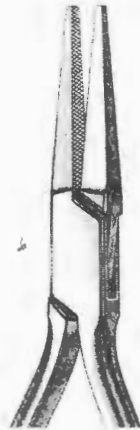

**-09D-002**  
Lab and Office



**-09D-003**  
Round Nose Plier  
5½" (14 cm)



**-09D-004**  
Langenbeck  
Round Nose Plier  
5½" (14 cm)



**-09D-005**  
Also Suitable for Jaraback Technic  
5½" (14 cm)



**-09D-006**  
5" (13 cm)

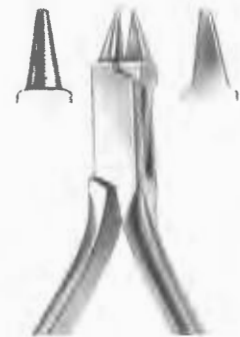

**-09D-007**  
Angle  
for wire up to 0.7 mm diam  
5" (12,5 cm)



**-09D-008**  
Adams  
5" (12,5 cm)



**-09D-009**  
Frevert  
5" (12,5 cm)

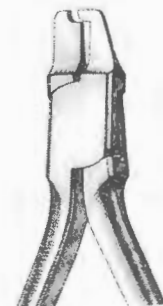

**-09D-010**  
417-Crown and Shell

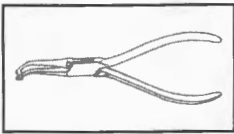

09D

# PLIERS



**-09D-011**  
Wire Bending



**-09D-012**  
How Crown,  
Straight



**-09D-013**  
How Crown,  
Curved



**-09D-014**  
Weingart, Utility

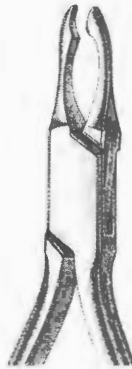

**-09D-015**  
Johnson, Contouring



**-09D-016**  
Reynolds, Contouring



**-09D-017**  
Clasp Adjusting

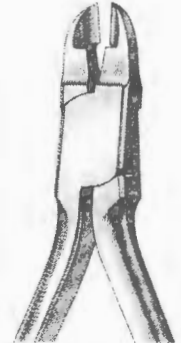

**-09D-018**  
Carbide Tipped Ligature Cutter



**-09D-019**  
Universal Plier



**-09D-020**  
for wire up to 1.0 mm diam  
6 1/4" (16 cm)



**-09D-021**  
Angle Plier  
5 1/2" (13 cm)



**-09D-022**  
Angle Plier  
5 1/2" (13 cm)

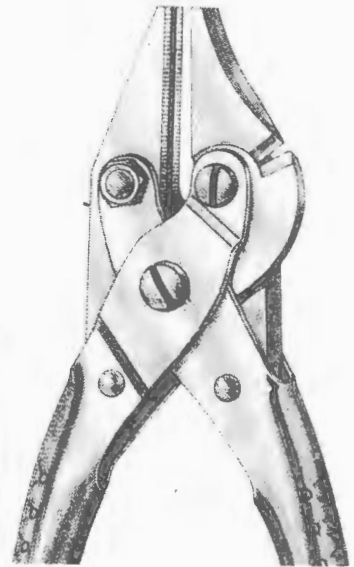

**-09D-023**  
Parallel Action Wire Cutter

# IMPRESSION TRAYS



## NON PERFORATED

UPPER

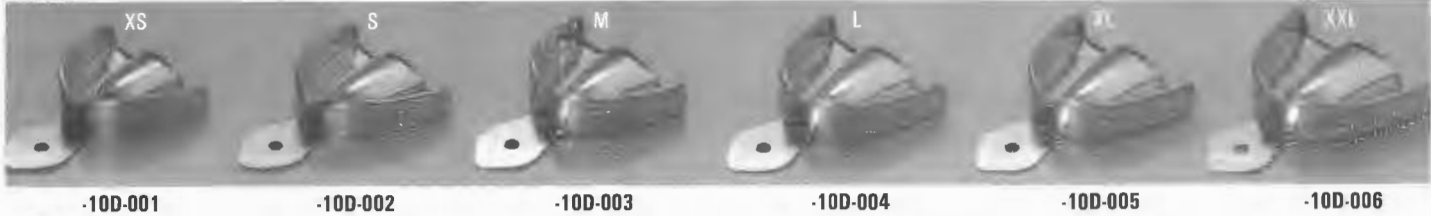

LOWER

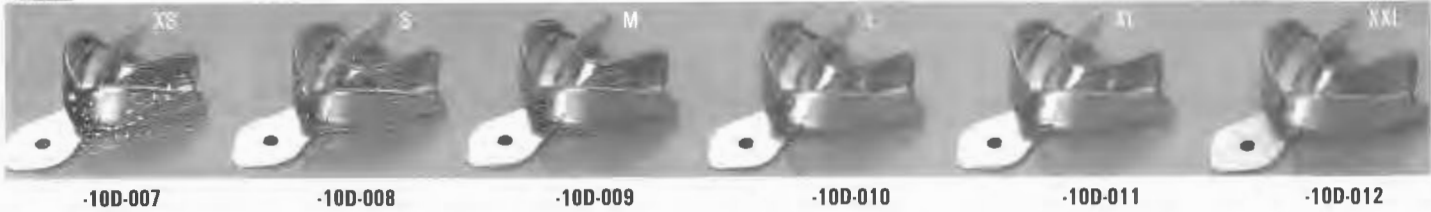

-10D-013  
Set of 6pcs

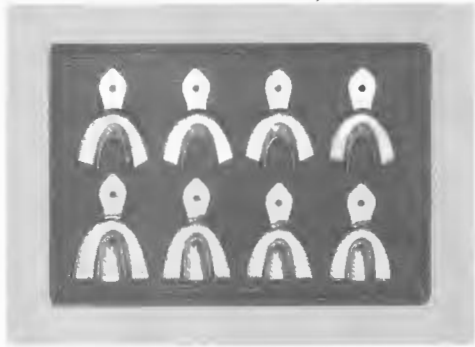

-10D-014  
Set of 8pcs

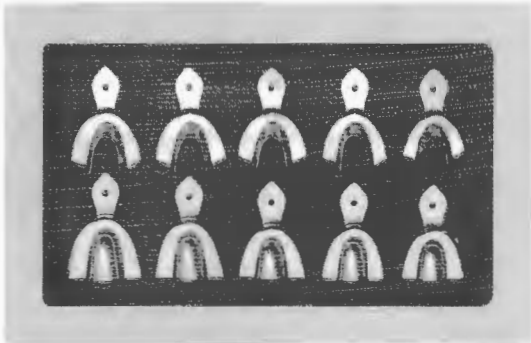

-10D-015  
Set of 10pcs

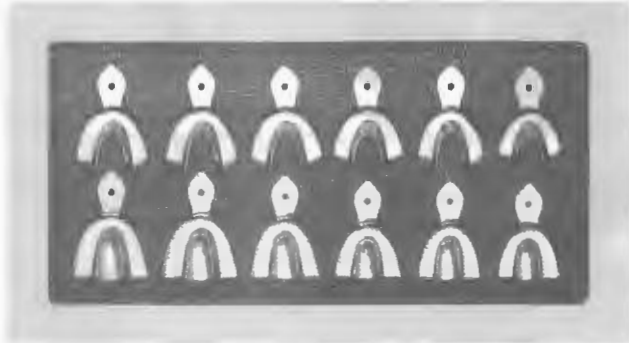

-10D-016  
Set of 12pcs

# INDEX

<b>A</b>	Page
ADAM PLIER	138
ADJUSTABLE HOOF TESTER	147
ADSDN BROW FORCEPS T.C	101
ADSDN BROWN FORCEPS	18
ADSDN FORCEPS	18
ADSDN FORCEPS MICRO T.C	101
ADSDN FORCEPS LASER	111
ADSDN FORCEPS T.C	101
ADSDN HEMOSTATIC FORCEPS	6
ADSDN NEEDLE HOLDER	24
ALCOHOL LAMP	112
ALLIS TISSUE FORCEPS	10
ALLIS TISSUE FORCEPS LASER	111
ALM RETRACTOR	32
AMALGAM CARRIER	123
AMALGAM CARRIER SWISS PATTERN	123
ANATOMY DISSECTING SET ADVANCE	142
ANATOMY DISSECTING SET PROFESSIONAL	142
ANGLE PLIER	138
ANGLE PLIER T.C	139
ARRUGA NEEDLE HOLDER	94
ARTERY FORCEPS SPENCERWELL	7
ARTICULATING PAPER FORCEPS	126
ASPIRATION SYRING	124
AUFRICTH CURETTE	50
AUVARD VAGINAL SPECULUM	77
AYER CHALAZIDN FORCEPS	8

<b>B</b>	Page
BABCOCK FORCEPS	10
BABY MIXER ARTERY FORCEPS	8
BACKHAUS TOWEL CLAMP	12
BACKHAUS TOWEL CLAMP LASER	110
BAILEY RIB CONTRACTORS	54
BALFOUR CENTER BLADE	33
BALFOUR RETRACTOR	33
BALL & SOCKET TOWEL CLAMP	12
BALL CHAIN	125
BALLENGER SPETUM KNIVES	48
BALLING GUN	146
BANOAGE SCISSORS	16
BANGDLEA HEMOSTATIC FORCEPS	9
BARRAQUER EYE SPECULUM	86
BARRAQUER NEEDOLE HOLDER	93
BARRAQUER SCISSORS	90
BARRETT TENACULUM FORCEPS	74
BARRON SUCTION TUBE	49
BARTH EAR CURETTE	45
BASIN EMISES	114
BAUMGARTNER NEEDLE HOLDER	23
BAYONET FORCEPS T.C	101
BECKMANN NASAL SPECULUM	38
BEDPAN AMERICAN TYPE	114
BEDPAN SLIPER TYPE	114
BELLUCCI MICRO EAR FORCEPS	42
BILLEAU EAR FORCEPS	45
BIRCHER GANSKE FORCEPS	83
BISHOP HARTMAN FORCEPS	88
BLADE BREAKER	94
BLADES B.P HANDLE	142
BLUMENTHAL BONE RONGUER	68
BOLEY GUAGE	126
BOLT CUTTER	72
BONE & RIB SHEARS	50
BONE CHISEL	61, 135
BONE CUTTER T.C	107
BONE FILE	134
BONE GOUGE	61
BONE HAND DRILL	58
BONE HOLDING FORCEPS	63, 64
BONE RONGUERS	68, 69
BONNEY TISSUE FORCEPS	21
BONNEY TISSUE FORCEPS T.C	102

	Page
BOZEMAN FORCEPS LASER	109
BOZEMAN UTERINE DRESSING FORCEPS	74
BRAUN STADLER SCISSORS	17
BROWN NEEDLE HOLDER	23
BRUNNER STERNUM SCISSORS	52
BRUNS BONE CURETTE	60
BRWEER RUBBER DAM FORCEPS	136
BUCK EAR CURETTE	45
BUCK EAR FORCEPS	44
BUCK PERCUSSION HAMMER	2, 144
BUCKET	113
BUCKET KICK STAND	113
BULL LEAD	147
BULL RINGS	147
BURFORD-FINOCHITOO RIB SPREADERS	53
BURKE BIOPSY FORCEPS	82
BURNISHERS	131

<b>C</b>	Page
CAMPION LASER FORCEPS	109
CANINE MOUTH GAG	146
CARHALT SPLINTER FORCEPS	22
CARMALT FORCEPS	7
CASPER RETRACTOR FOR SPINE	54
CAST SPREADER 3PRONG	67
CASTROVIEJO BLADE BREAKER	94
CASTROVIEJO CALIPER	86
CASTROVIEJO CORNEAL SCISSORS	91
CASTROVIEJO FIXATION FORCEPS	89
CASTROVIEJO KALT NEEDLE HOLDER	94
CASTROVIEJO NEEDLE HOLDER	92
CASTROVIEJO SCISSORS	90
CASTROVIEJO SPATULA	85
CATHETER TRAY	112
CATRIDGE SYRING	124
CEMENT SPATULA	133
CHARRIERE RESECTION SAW	59
CHARRIERE SAW	59
CLASP ADJUSTING PLIER	139
CLEVELAND BONE CUTTING FORCEPS	71
CLIP APPLYING FORCEPS	56
CLOWARD LAMINA SPREADERS	55
COLIBRI FORCEPS	87
COLLEGE TWEEZER	126
COLLIER NEEDLE HOLDER	23
COLLIN ABDOMINAL RETRACTOR	33
COLLIN CLAMP	83
COLLIN DUVAL GRASPING FORCEPS	21
COLLIN HAMMER	62
COLLIN VAGINAL SPECULUM	77
COLLIN TONGUE FORCEPS	35
COLOUMBIA RETRACTOR	36
COLUMBIA CURETTE	128
CONE RETRACTOR	32
COOLEY RIB SPREADERS	53
COTTLE CURETTE	50
COTTON WOOL CONTAINER	113
COTTON WOOL DISPENSER	112
CRILE HEMOSTATIC FORCEPS	5
CRILE MURRAY NEEDLE HOLDER	24
CRILE NEEDLE HOLDER	25
CRILE RANKIN HEMOSTATIC FORCEPS	5
CRILE WOOD NEEDLE HOLDER	24
CROWN & SHELL REMOVING PLIER	138
CROWN GUAGE	125
CRUSH EMASCULATOR	148
CRUTCHFIELD TRACTION	55
CUSHING DRESSING / TISSUE FORCEPS	20
CUSHING DRESSING FORCEPS T.C	102
CUSHING LAMINECTOMY RONGUERS	57
CUSSCO VAGINAL SPECULUM	77
CUZZI SPDON	84

<b>D</b>	Page
DAHLGREN INSTRUMENTS	55
DANDY HEMOSTATIC FORCEPS	6
DAVIS BOYLE MOUTH GAG	37
DE VIBISS INSTRUMENTS	55
DE-BAKEY DRESSING FORCEPS	95
DE-BAKEY FORCEPS	95, 96
DE-BAKEY SCISSORS	17
DE-BAKEY VASCULA DILATOR	76
DEJERINE PERCUSSION HAMMER	2
DELEE RETRACTOR	31
DENHAROT MOUTH GAG	36
DENIS BROWN ABDOMINA RETRACTOR	34
DERF NEEDLE HOLDER	23
DESMARRESS CHALLAZION FORCEPS	88
DESMARRESS LID RETRACTOR	85
DESMARRESS RETRACTOR	27
DEVER RETRACTOR	28
DIAGNOSTIC SET	142
DIAMANT WIRE CUTTING PLIER	73
DILATOR'S	76
DINGMANN BONE FORCEPS	63
DISPOSABLE SYRINGE STERILE	145
DISSECTING SET	142
DITTEL SOUND	76
DOYEN ABDOMINAL SCISSORS	17
DOYEN BIOPSY FORCEPS	81
DOYEN HAMMER	62
DOYEN VAGINAL SPECULA	78
DRENCH PUMP	146
DRESSING FORCEPS	19
DRESSING FORCEPS T.C	102
DRESSING SCISSORS T.C	97
DURANTE TISSUE FORCEPS	21
DUVAL TISSUE FORCEPS	21

<b>E</b>	Page
EXTRACTING FORCEPS	115 TO 117
EANGLE CAST SAW	67
EAR FORCEPS	41 TO 46
EAR SPECULUM	40
EAR SYRINGE	40
ECHLIN BONE RONGUER	69
ELASTRATOR	148
ELDCHING FIXATION FORCEPS	89
ELEVATORS	118 TO 121
EMASCULATOR	133
EMISES BASIN	114
EPPENDORF BIOPSY FORCEPS	81
ERHARDT CHALAZION FORCEPS	88
EVANS TISSUE FORCEPS	103
EXCAVATORS	130
EXPLORER	132

<b>F</b>	Page
FARABEUF BONE HOLDING FORCEPS	66
FARABEUF LAMBOTTE BONE HOLDING FORCEPS	66
FARABEUF RETRACTOR	27
FERGUSSON BONE HOLDING FORCEPS	64
FERRIS SMITH KERISION RONGUER	57
FINOCHITOO RIB SPREADERS	53
FISCH EAR INSTRUMENTS	46
FLAT NOSE PLIER	72, 73
FOERSTER SPONG FORCEPS	11
FORCEPS JAR	112
FRAZIER DURA HOOK	26
FRAZIER SUCTION TUBE	49
FRENCH LAMINECTOMY SPREADERS	54
FREVERT PLIER	138
FRITSCH RETRACTOR	31
FROSCH BONE HOLDING FORCEPS	64







# INDEX

	Page
VIENNA NASAL SPECULUM	39
VIRTUS SPLINTER FORCEPS	22
VOLKMAN BONE CURETTE	60
VOLKMAN RETRACTOR	29
VOLTOLINI NASAL SPECULUM	39

## W

WAGENER EAR FORCEPS	45
WALTER SPLINTER FORCEPS	22
WANGENSTEEN FORCEPS T.C	101
WARTENBERG NEUROLOGICAL PIN WHEEL	2
WAX CARVERS	129
WEBSTER NEEDLE HOLDER	23
WECKER SCISSORS	90
WEIL BLAKESLEY RONGUER	56
WEINGART UTILITY PLIER	139
WEITLANER RETRACTOR	32
WESTCOTT TENOTOMY SCISSORS	91
WHEELER SPATULA	85
WHITE TOENAIL SCISSORS	146
WHITEHEAD MOUTH GAG	36
WIENER SKIN HOOK	26
WILLIAM SPLINTER FORCEPS	22
WILLIAMS TISSUE FORCEPS T.C	103
WILLIGER HAMMER	62
WINDOW POUNCHER	145
WINTER BIOPSY FORCEPS	81
WINTER FORCEPS	83
WIRE BENDING PLIER	139
WIRE CUTTING FORCEPS T.C	107
WIRE CUTTING PLIER	72, 73
WIRE HOLDING FORCEPS T.C	107
WIRE MASH TRAY	114
WIRE TWISTING FORCEPS T.C	107
WULLSEIN CURETTE	47
WULLSTEIN EAR INSTRUMENTS	46

## Y

YOUNG TONGUE FORCEPS	35, 144
----------------------	---------



Christian Town, Kashmir Road, Saikot Pakistan.

Tel:- +92-52-4293371-73

Fax:- +92-52-4293374

E-mail:- [office@solatchsons.biz](mailto:office@solatchsons.biz)

[sales@solatchsons.biz](mailto:sales@solatchsons.biz)

Web:- [www.solmed.biz](http://www.solmed.biz)